

ROOM
Luxembourg

sesta
SEDE E POLTRONE PER L'UFFICIO E LA COMUNITÀ

DESIGN—2018
EXECUTIVE
TASK
VISITORS/
CONFERENCE
LOUNGE/
MEETING

DESIGNCOLLECTION

sesta!

Sesta, progetta e produce sedie di Design destinate all'arredamento per l'Ufficio e per la Comunità, seguendo l'obiettivo di creare famiglie omogenee di prodotti dotati di forte personalità e versatilità, che possano soddisfare la creatività dei progettisti.

Sesta proposes and manufactures design chairs for office and community furnishings. The purpose is to create a similar group of products with a strong and adaptable personality in order to satisfy the creativity of the designers.

Sesta conçoit et produit des sièges de Design pour les bureaux et les espaces collectifs, avec comme objectif la création de familles homogènes de produits à la forte personnalité et à la grande adaptabilité, qui conviennent à merveille à la créativité des concepteurs.

Sesta, entwickelt und produziert Design-Sitzmöbel für die Einrichtung von Büros und Gemeinschaftsräume. Dabei wird das Ziel verfolgt, homogene Produktfamilien mit starkem Charakter und Vielseitigkeit die die Kreativität der Planer und Projektanten befriedigen können.

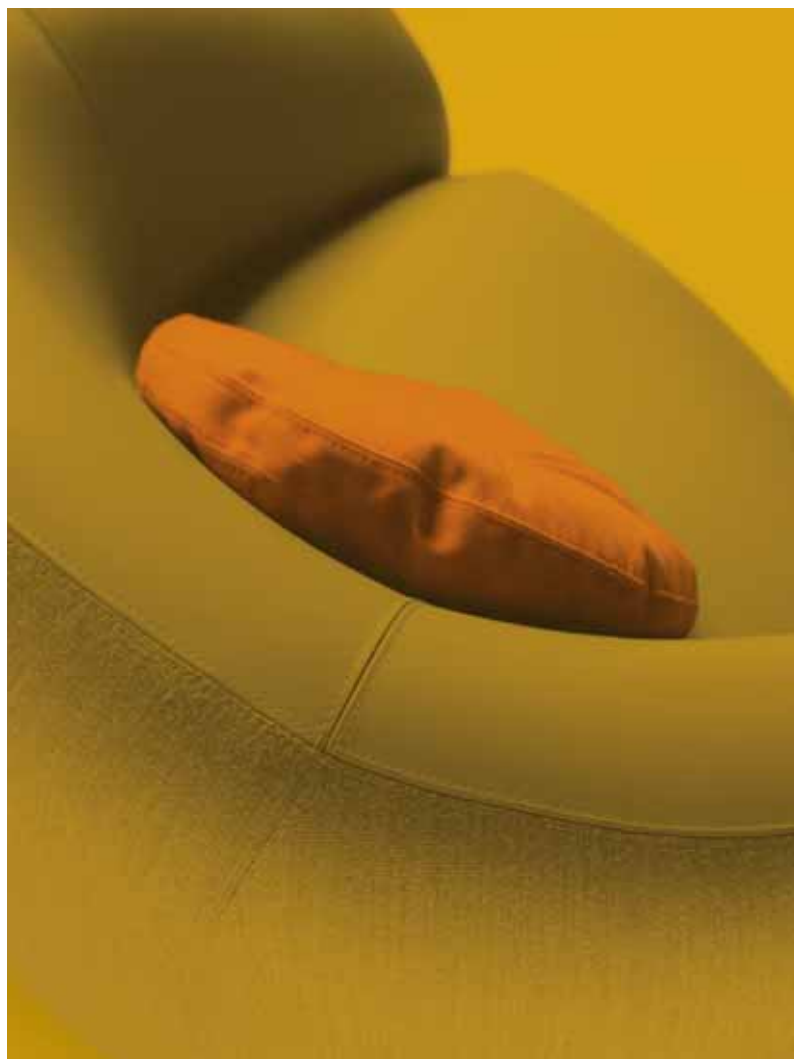

P.

007

EXECUTIVE

P.

035

TASK

P.

049

**VISITORS/
CONFERENCE**

P.

123

**LOUNGE/
MEETING**

P.

193

**INFORMAZIONI
TECNICHE**

TECHNICAL INFORMATION
INFORMATIONS TECHNIQUES
TECHNISCHE INFORMATIONEN

P.

227

**FINITURE/
RIVESTIMENTI**

FINISHES/COVERINGS
FINITIONS/REVÊTEMENTS
AUSFÜHRUNGEN/BEZÜGE







007

EXECUTIVE



JADA
p. 8



DAMA
p. 14



MODÀ
p. 20



MODE
p. 24



WIN
p. 26



ADA 1
p. 30



ADA LX
p. 32



Mod. JD-003 + op. JD-110
Mec. Synchro SY109



Mod. JD-010 + op. JD-100 + op. JD-112-01
Mec. A19





Mod. JD-003 + op. JD-100 + op. JD-112-02
Mec. Synchro SY109



op. JD-100

Mod. JD-004 + op. JD-100
+ op. JD-112-02
Mec. A19



Mod. JD-017 + op. JD-112-02
Mec. A20G



Mod. JD-017
Mec. A20G-LU



Mod. JD-016 + op. JD-100 + op. JD-110
Mec. A20G-N



Mod. JD-056
Mec. TORNA



Mod. JD-046
Mec. A20G



Mod. DA-002
Mec. Synchro SLYD



Mod. DA-007
Mec. Synchro SLYD





art.

Mod. DA-007
Mec. Synchro SLYD

Mod. DA-017



Mod. DA-022



Mod. DA-037
Mec. CT1



Mod. DA-027



Mod. DA-042
Mec. CT1



Mod. DA-102
Mec. Synchro SLYD



Mod. DA-107
Mec. Synchro SLYD



Mod. DA-112



Mod. DA-116



Mod. DA-127



Mod. DA-142
Mec. CT1



Mod. MA-002
Mec. Synchro SYM



Mod. MA-006
Mec. AX7



Mod. MA-011



Mod. MA-013



Mod. MA-015
Mec. Gaslift



Mod. MA-022
Mec. Synchro SYM



Mod. MA-026
Mec. AX7



Mod. MA-030
Mec. Gaslift



Mod. MA-032



Mod. MA-033



STRIP Mod. MO-118
Mec. Synchro SYM



STRIP Mod. MO-242
Mec. AX7



PLAIN Mod. MO-004
Mec. Synchro SYM



PLAIN Mod. MO-287
Mec. AX7

STRIP Mod. MO-104
Mec. Synchro SYM





SLIM Mod. WS-032
Mec. Synchro SYR



SLIM Mod. WS-057 + op. A21-70
Mec. Gaslift



IMBOTTITA Mod. WI-102-01
Mec. Synchro SLYR



IMBOTTITA Mod. WI-148 + op. A21-70
Mec. Gaslift

IMBOTTITA Mod. WI-102-01
Mec. Synchro SLYR

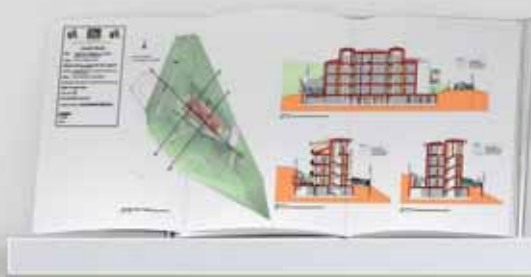

Mod. WR-202-01
Mec. Synchro SLYR





Mod. WR-212-01 + op. W-ADH
Mec. Synchro SLYR



Mod. WR-222
Mec. Synchro SYR



Mod. WR-247
Mec. Gaslift



ADA 1 Mod. A1-2102-01
Mec. Synchro SLYR



ADA 1 Mod. A1-2106-01 + op. A1-ADH
Mec. Synchro SLYR



ADA 1 PLUS Mod. A1-2202
Mec. Synchro SLYR



ADA 1 PLUS Mod. A1-2214 + op. A21-70
Mec. Gaslift

ADA 1 Mod. A1-2102-01
Mec. Synchro SLYR





LX Mod. LX-002-01 + LX-ADH
Mec. Synchro SLYR



LX Mod. LX-010
Mec. Gaslift



LX PLUS Mod. LX-022
Mec. Synchro SLYR



LX PLUS Mod. LX-028 + op. A21-70
Mec. Gaslift



LX PLUS Mod. LX-016
Mec. Synchro SLYR



035

TASK



SAX Rete, Air, 8
p. 36



SAX 24
P. 42



WIN Task
P. 44



CALIBRA Light
P. 46



Mod. SR-046 + op. 14BH
Mec. Synchro SY24



Mod. SR-073



Mod. SR-W44 + op. 13BHW
Mec. Synchro SY24



Mod. SR-W51 + op. 13BHW
Mec. Synchro PSY6

Mod. SR-W51 + op. 13BHW + op. SR-303
Synchro PSY6

Mod. SR-W61





AIR WHITE Mod. SA-W04 + op. 13BHW + op. SA-303
Mec. Synchro SY24



AIR Mod. SA-006 + op. 14BH + op. SA-302
Mec. Synchro SY24



AIR Mod. SA-032 + op. SA-301



AIR WHITE Mod. SA-W11 + op. 13BHW
Mec. Synchro PSY6



AIR WHITE Mod. SA-W11 + op. A21-70
Mec. Synchro PSY6

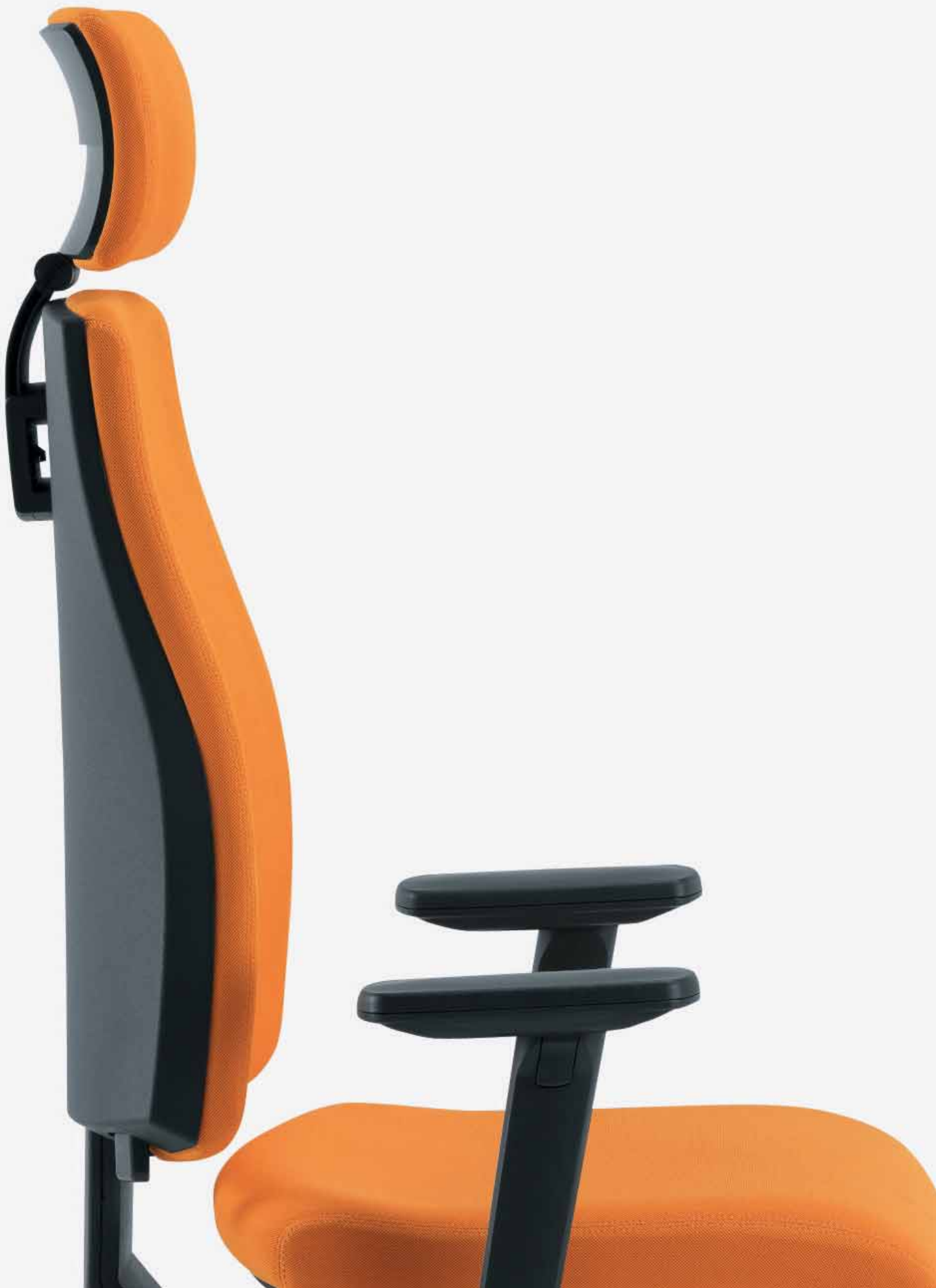



Mod. S8-085 + op. 14BH
Mec. Synchro SY24



Mod. S8-092
Mec. Synchro PSY6



Mod. S8-091 + op. 13BH
Mec. Synchro PSY6



Mod. SX-211
Mec. Synchro SY24



Mod. SX-207
Mec. Synchro SY24



Mod. SX-207
Mec. Synchro SY24

Mod. SX-211
Mec. Synchro SY24





SLIM Mod. WS-017-02
Mec. Synchro SLYR



IM Mod. WI-132-02
Mec. Synchro SLYR



RETE Mod. WR-216-02
Mec. Synchro SLYR

RETE Mod. WR-232-02
Mec. Synchro SLYR

*Ogni traccia di purissima
collaborazione tra gli uomini
si fonda in primo luogo
sulla fiducia reciproca...
Ciò è vero tanto per le nazioni
quanto per i singoli individui.
E la fiducia si costruisce
venendo.*



046.

Mod. CY-126 + op. 11BHGR
Mec. PCS4





Mod. CY-131
Mec. PCS4

Mod. CY-121
Mec. PCS4



Mod. CY-122
Mec. PCS4



049

VISITORS/ CONFERENCE



FRILL
NOFRILL
p. 50



EASY GO
p. 92



GO MEET
p. 110



Q2
p. 56



CARINA
CARINA Skid
CARINA Basket
p. 96



GO LITE
p. 112



Q-44 XL
Q-44
p. 68



TA-CHERIE
p. 104



Q-44 Banco
p. 114



Q-EASY XL
Q-EASY
p. 74



ADA 2
p. 106



Q-44 Tip-Up
p. 116



Q-FOUR XL
Q-FOUR
p. 80



ADA 2 Fold
p. 108



Q-44 Conference
p. 118



Q-GO XL
Q-GO
p. 86



AUDITORIUM
p. 120



Mod. FL-003 + op. FL-120 + op. FL-132



Mod. FL-002



Mod. FL-011 + op. FL-120



Mod. FL-011



Mod. FL-002



Mod. FL-043 + op. FL-124 + 3x op. FL-120



Mod. FL-013



Mod. FL-006 + op. FL-120



Mod. FL-005 + op. FL-131



Mod. FL-022 + op. FL-120



Mod. FL-016



Mod. FL-026 + op. FL-120



Mod. FL-057



Mod. FL-052 | Mod. FL-053



Mod. FL-065 + op. FL-120 + op. A25-50



Mod. FL-067

Mod. FL-059 + op. FL-120
Mod. LL-038







op. Q2-501



IM Mod. Q2-447 + op. Q2-501



IM Mod. Q2-446



TP/FAST scrittoio | writing tablet | tablette écrioire | Schreibbrett



WIM Mod. Q2-217 + op. Q2-56DX
TP/FAST



IM Mod. Q2-222 + op. Q2-336



WIM Mod. Q2-038

WIM Mod. Q2-217 + op. Q2-56DX
TP/FAST





WIM Mod. Q2-128
Mod. LL-118



IM Mod. Q2-438



IM Mod. Q2-013



WIM Mod. Q2-428



TP/HOOK scrittoio | writing tablet | tablette écrioire | Schreibbrett



WIM Mod. Q2-423 + op. Q2-102
TP/HOOK



WIM Mod. Q2-428 + op. Q2-102
TP/HOOK



IM Mod. Q2-447 + op. Q2-102
TP/HOOK





W Mod. Q2-153 + op. Q2-332



op. Q2-105



W Mod. Q2-003 + op. Q2-331



W Mod. Q2-153



IM Mod. Q2-203



W Mod. Q2-193 + op. Q2-331



W Mod. Q2-251



WIM Mod. Q2-252



IM Mod. Q2-327 + op. Q2-357 + Q2-362



W Mod. Q2-262 + 2x op. Q2-331



IM Mod. Q2-327 + op. Q2-357 + op. Q2-362





XL RETE Mod. Q4-RX102



XL RETE Mod. Q4-RX107



XL RETE Mod. Q4-RX117



XL RETE Mod. Q4-RX138



XL AIR Mod. Q4-AX202



XL AIR Mod. Q4-AX222



XL AIR Mod. Q4-AX236



XL AIR Mod. Q4-AX202 + op. Q4-351 + op. Q4-355



XL AIR Mod. Q4-AX202 + op. Q4-351 + op. Q4-355 + op. Q4-311

072.



Q44/TP scrittoio | writing tablet | tablette écriteiro | Schreibbrett



IM Mod. Q4-031



IM Mod. Q4-072 + op. Q4-319



RETE Mod. Q4-536



RETE Mod. Q4-096



IM Mod. Q4-576



RETE 2x Mod. Q4-216 + op. Q4-318





XL RETE Mod. QE-RX107 + op. QE-301



XL RETE Mod. QE-RX108



XL RETE Mod. QE-RX109



XL RETE Mod. QE-RX107



XL AIR Mod. QE-AX202



XL AIR Mod. QE-AX202



XL AIR Mod. QE-AX206



XL AIR Mod. QE-AX209

XL AIR Mod. QE-AX207
Mod. LL-032





RETE Mod. QE-008



RETE Mod. QE-018



IMPP Mod. QE-002



IM Mod. QE-005





XL RETE Mod. QF-RX108



XL RETE Mod. QF-RX102



XL RETE Mod. QF-RX107



XL AIR Mod. QF-AX202



XL AIR Mod. QF-AX207



XL AIR Mod. QF-AX206



084.



RETE Mod. QF-018



IMPP Mod. QF-002



IM Mod. QF-015



RETE Mod. QF-008





XL RETE Mod. QG-RX117
+ op. QG-1510 + op. QG-1501
TP/US



XL RETE Mod. QG-RX112 + op. QG-1511
TP/EU



XL RETE Mod. QG-RX112 + op. QG-1511 + op. QG-1508
TP/EU



XL AIR Mod. QG-AX101



XL AIR Mod. QG-AX116 + op. QG-1501
TP/US



XL AIR Mod. QG-AX107 + op. QG-1510



XL AIR Mod. QG-AX107 + op. QG-1510



XL AIR Mod. QG-AX116 + op. QG-1501
TP/US

Mod. QG-032 + op. QG-1511 + op. QG-1509
TP/US





IM Mod. QG-015



IMPP Mod. QG-012



RETE Mod. QG-028 + op. QG-1511
+ op. QG-1600 + op. QG-1508
TP/EU



IMPP Mod. QG-032 + op. QG-1511
+ op. QG-1509
TP/US



PP Mod. GO-1442 + op. GO-1510



op. GO-741
TP/EU







IMPP Mod. GO-1476 + op. GO-1509
TP/US



IMPP Mod. GO-1426



IMPP Mod. GO-1476 + op. GO-1509 + op. GO-1511
TP/US



Mod. CA-588



Mod. CA-1311



op. CA-741

Mod. CA-588





CH/TPN scrittoio, sedia impilabile | writing tablet, stackable chair | tablette écrioire, chaise empilable | Schreibbrett, Stapelstuhl



Mod. CA-692 + op. CA-713



Mod. CA-692-01 + op. CA-722
CH/TPN



CH/BSK scrittoio, sedia impilabile | writing tablet, stackable chair | tablette écrioire, chaise empilable | Schreibbrett, Stapelstuhl



Mod. CA-1402 + op. CA-613



Mod. CA-1411
CH/BSK



Mod. CA-1407 + op. CA-703





TP/FAST scrittoio | writing tablet | tablette écriteiro | Schreibbrett



Mod. CA-1407



Mod. CA-1408-01 + op. CA-613





Mod. CA-BKTP + op. CA-613



Mod. CA-BKTP

Mod. TC-718-01 + op. TC-731
CH-TPN





Mod. TC-507 + op. TC-804



Mod. TC-719 + op. TC-741



Mod. TC-502



Mod. TC-517 + 3x op. TC-802



A2 Mod. A2-2143 + op. A2-2151



A2 Mod. A2-2141 + op. A27G-45X4



A2 Mod. A2-2143 + op. A2-2152



op. A2-2150

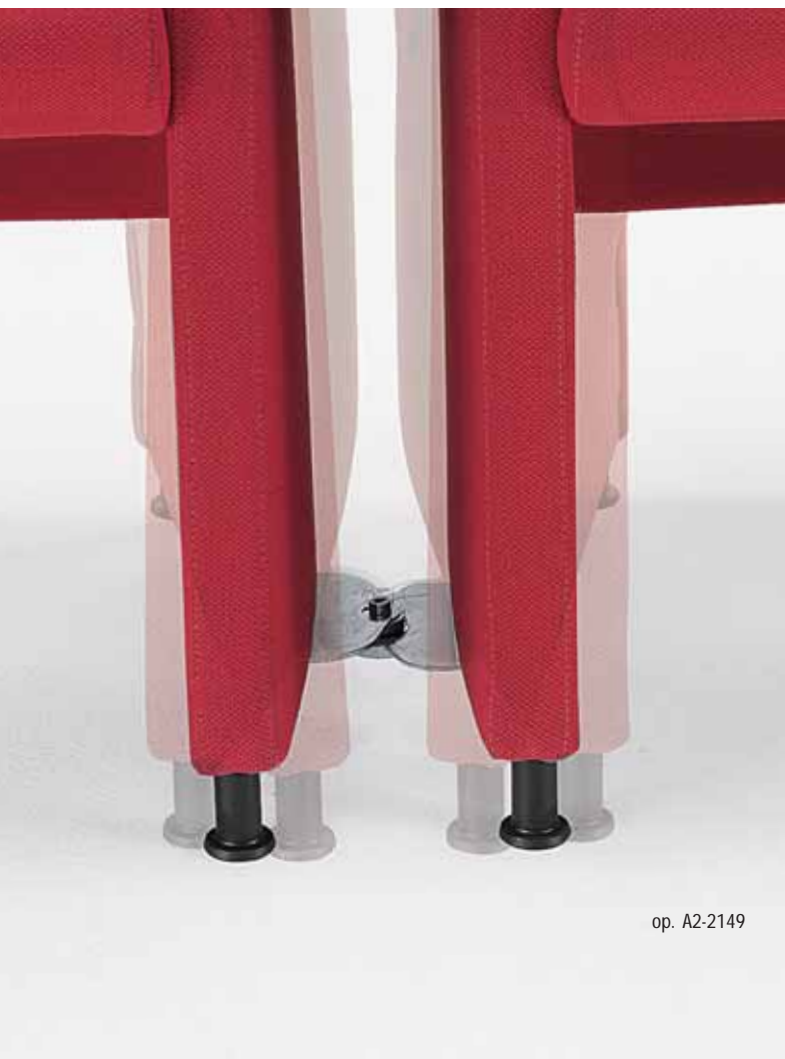

op. A2-2149



op. A2-FX



A2 FOLD Mod. AF-005



A2 FOLD Mod. AF-001



A2 FOLD Mod. AF-001

A2 FOLD Mod. AF-002 + op. AF-2150





LONDRA



NEW YORK



TOKYO





Mod. GM-082



Mod. GM-083



Mod. GL-043



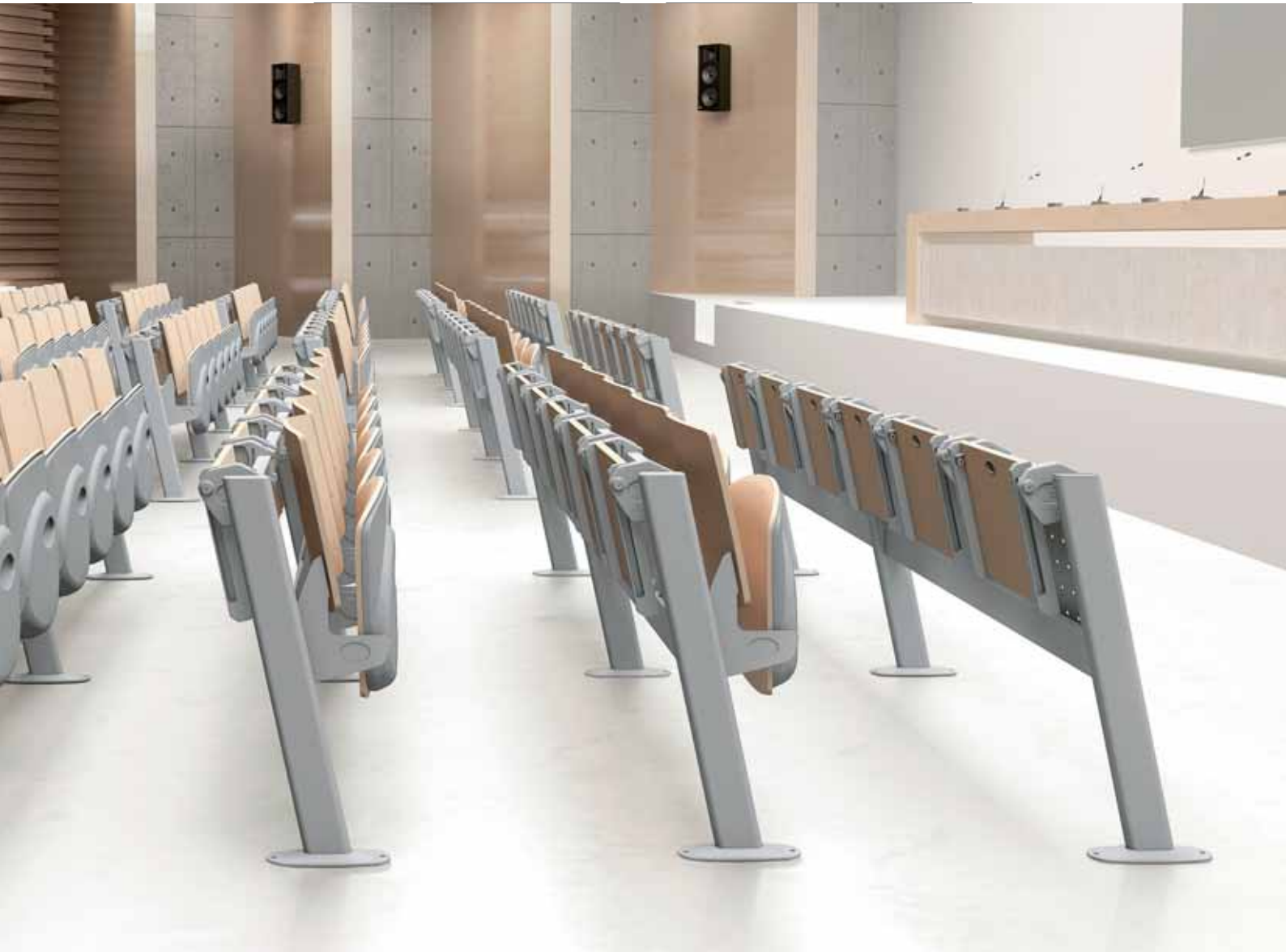



W Mod. QB-008
Top fisso | Fixed top | Plateau fixe | Platte fest



IM Mod. QB-006
Top fisso | Fixed top | Plateau fixe | Platte fest



PP Mod. QB-012
Top ribaltabile | Folding top | Plateau rabattabile | Platte klappbar



PP 3x Mod. TU-001



IMPP 3x Mod. TU-024 + 3x TU-041



W 3x Mod. TU-018 + 4x op. TU-037



IM 3x Mod. TU-016 + 4x op. TU-039



IMPP Mod. TU-024





Mod. 4x QC-002 + op. QC-004



Mod. 4x QC-002 + op. QC-004



Mod. AU-001 x4 + op. AU-003



Mod. AU-002 + op. AU-003

Mod. AU-001 + op. AU-003



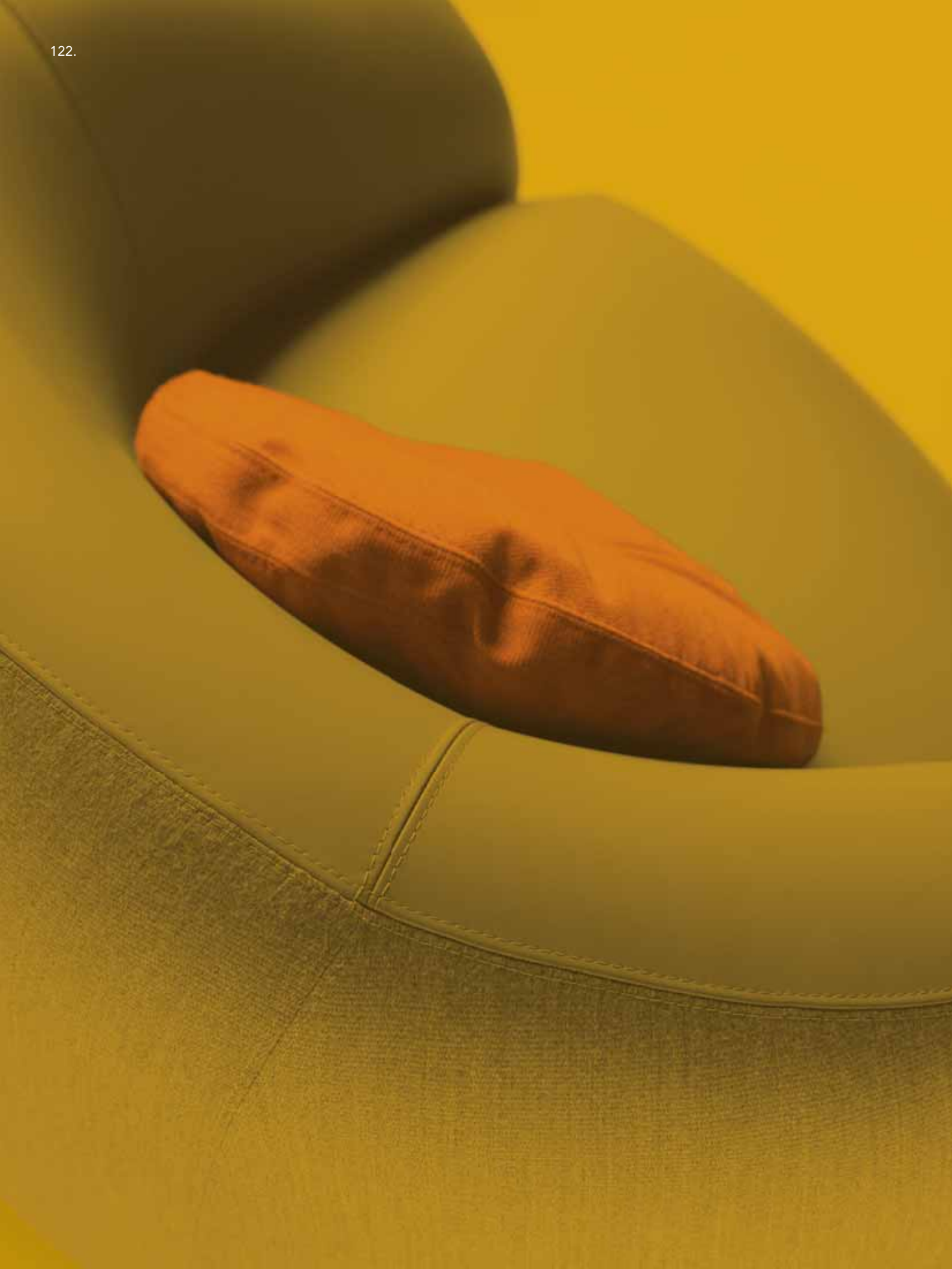

123

LOUNGE/ MEETING



BLOG *
p. 124



PAUL&FRANK
p. 156



ANDREW
p. 174



BOTERO
p. 138



MODE Small
MODE TC
p. 158



MODULO
p. 176



DAY&NIGHT
D&N Pad
D&N Plus
p. 142



MODÌ
p. 162



LINATE
p. 178



SMILE
p. 148



MODÀ Lounge
p. 164



Q-44 Fix
p. 180



BIG
p. 150



DAMA Lounge
p. 166



TOMMY
p. 182



FREE
p. 152



ADA 3
ADA 4
p. 168



TAVOLI
p. 184



LOLA
p. 154



BRERA
p. 172



TAVOLINI
p. 188































Mod. BT-003



Mod. BT-001 + op. BT-MIX



Mod. BT-016



Mod. BT-012



Mod. BT-004





Mod. BT-001



Mod. BT-004



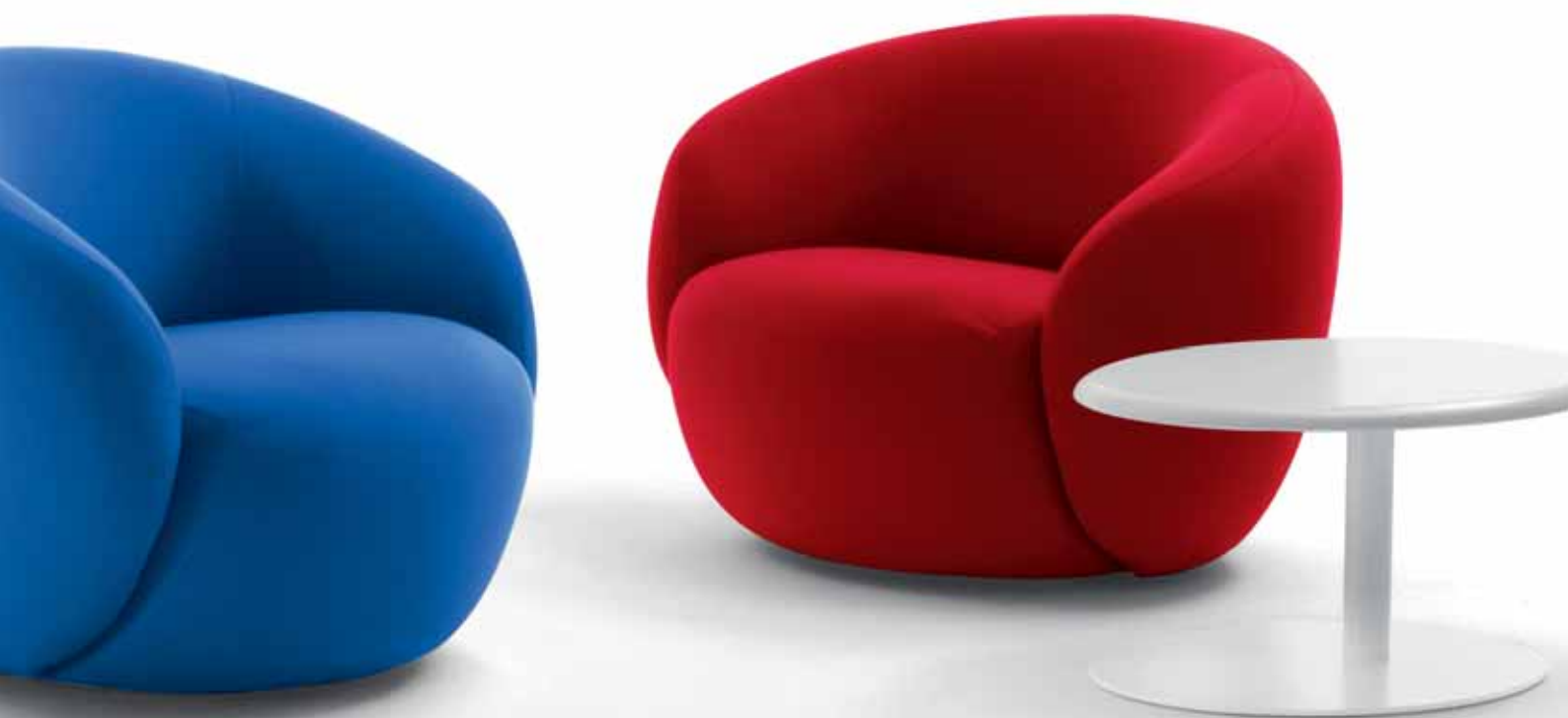

Mod. BT-016



Mod. DN-1832



Mod. DN-1805



Mod. DN-1815



Mod. DN-1834 + op. DN-1820



Mod. DN-1836 + op. DN-1820

Mod. DN-1800 + op. DN-1820



144.

Mod. DP-021





Mod. DP-021



Mod. DP-026



Mod. DP-031



Mod. DP-003



Mod. DS-042



Mod. DS-061



Mod. DS-056



Mod. DS-051



Mod. SM-002



Mod. SM-006



Mod. SM-012



Mod. SM-002
Mod. SM-014



Mod. BI-002



Mod. BI-002 + op. BI-006

Mod. BI-002 + op. BI-006



Mod. FR-016
Mod. LL-062





Mod. FR-031



Mod. FR-009



Mod. FR-025



Mod. FR-020



Mod. LL-011



Mod. LL-015



Mod. LL-004



Mod. LL-010

Mod. LL-005





PAUL Mod. PF-103



PAUL Mod. PF-133



Mod. PF-056



Mod. PF-041 + op. PF-072



FRANK Mod. PF-016



FRANK Mod. PF-034 + op. PF-069



Mod. MO-075



Mod. MO-338



Mod. MO-079



Mod. MO-092



Mod. MO-159
Mec. TORNA



Mod. MO-322



Mod. MO-180



Mod. MO-190 + op. MO-402 + op. MO-404 + op. MO-407

Mod. MO-085



LOUNGE/MEETING / MODE TC Plain

TC XL Mod. MO-342 TC Mod. MO-185





Mod. MD-004



Mod. MD-012
Mec. Gaslift



Mod. MD-010
Mec. Gaslift

Mod. MD-002
Mec. TORNA







MOD. ML-001
Mec. A20



MOD. ML-002
Mec. A20



Mod. DL-102 + op. DL-117



Mod. DL-108 + op. DL-118



Mod. DL-002

Mod. DL-122



Mod. A3-2131



Mod. A3-2122



Mod. A3-2127



Mod. A3-2116



Mod. A3-2122
Mod. TA-006



Mod. A4-031

Mod. A4-044



ADA 4 Mod. A4-011



ADA 4 Mod. A4-031



ADA 4 PLUS Mod. A4-012



ADA 4 PLUS Mod. A4-033



Mod. BR-004



Mod. BR-002



MOD. BR-001



Mod. BR-003

Mod. BR-002
Mod. BR-004





Mod. AD-017 + 2x op. AD-053 | Mod. MU-026



Mod. AD-017 + op. AD-052 + AD-057



Mod. AD-002



Mod. AD-007 + op. AD-052



Mod. AD-012 + 2x op. AD-053



Mod. MU-006 + 2x op. MU-132



Mod. MU-006



Mod. MU-016



Mod. MU-032



Mod. MU-022



W 3x Mod. LI-006 + 3x op. LI-011 + op. LI-015





W 3x Mod. LI-001



W 3x Mod. LI-006 + 3x op. LI-011 + op. LI-016 + op. LI-015



IM 3x Mod. LI-008 + op. LI-015



W 3x Mod. LI-006 + 3x op. LI-012 + op. LI-016 + op. LI-015



W 3x Mod. QX-017



PP 3x Mod. QX-021 + op. QX-041



IMPP 3x Mod. QX-008 + op. QX-054



IM 3x Mod. QX-013 + 2x op. QX-043



IMPP 3x Mod. QX-008 + 2x op. QX-043

IM Mod. TO-1511-DS + 2x op. TO-1231





IM Mod. TO-1511-DS + 2x op. TO-1231



IM Mod. TO-1511



PP Mod. TO-1111-DS



W 3x Mod. TO-1662 + 3x TO-1611 + 3x TO-1621
+ TO-1647 + TO-1650 + 2x TO-1653 + 2x TO-1691
+ 2x op. TO-1671 + op. TO-1672





Mod. TA-006
70 x 70 x h 74 cm



Mod. TA-008
Ø 60 x h 113 cm



Mod. TA-001-01
Ø 60 x h 73 cm



Mod. TA-003
70 x 70 x h 73 cm



LOLA Mod. LL-071
Ø 70 x h 73 cm



LOLA Mod. LL-073
Ø 70 x h 73 cm

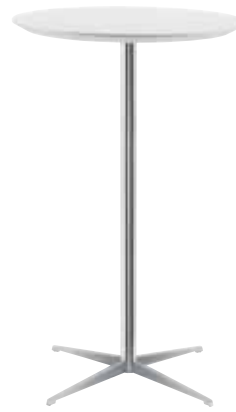

LOLA Mod. LL-027
Ø 70 x h 105 cm



Mod. TA-111-01
138 x 78 x h 75 cm



Mod. TA-111
138 x 78 x h 75 cm



Mod. TA-004
Mod. DS-042



Mod. LL-077
Mod. LL-005



Mod. TA-007
70 x 70 x h 32 cm



Mod. TA-015
Ø 42 x h 50 cm



ADA 3 | D&N PAD Mod. A3-2137
45 x 45 x h 45 cm



ADA 3 | D&N PAD Mod. A3-2136
70 x 70 x h 45 cm



SMILE Mod. SM-014
Ø 60 x h 37 cm



SMILE Mod. SM-020
Ø 70 x h 45 cm



LOLA Mod. LL-063
Ø 70 x h 40 cm



ADA 4 Mod. A4-042
70 x 70 x h 33 cm



ADA 4 Mod. A4-044
100 x 70 x h 33 cm



MODULO Mod. MU-022
60 x 60 x h 30 cm



BRERA Mod. BR-011
70 x 70 x h 34 cm



BRERA Mod. BR-012
100 x 70 x h 34 cm



BRERA Mod. BR-012

193

INFORMAZIONI TECNICHE

TECHNICAL INFORMATION
INFORMATIONS TECHNIQUES
TECHNISCHE INFORMATIONEN

Serie direzionale disponibile con poggiatesta, schienale alto o medio. Meccanismi: Synchro SY109 (autoregolante) con traslazione della seduta (op. SLYJ) e oscillante centrale A19.

Ospiti solo girevoli, con schienale alto e medio (scocca intera). Base in alluminio a 5 razze Ø 68 cm e a 4 razze Ø 70 cm definita "spider" con finitura lucida (LU) o nera (N). Base piana in acciaio Inox Ø 50 cm finitura cromata abbinata al ritorno automatico "TORNA" (non regolabile in altezza).

Executive series with headrest, and high or medium backrest. Mechanisms: Synchro SY109 (self-adjusting) with sliding seat device (op. SLYJ) and central tilt mechanism (A19). Visitor chair only available in swivel version, with high or medium backrest (whole shell), with "spider" base, 5-star base or flat stainless steel base (only with medium backrest), matched with "TORNA" automatic seat return (not height-adjustable). Armrests and bases in aluminium with polished (LU) and black (N) finish.

Fauteuil direction avec tête, dossier haut ou moyen. Mécanisme: Synchro SY109 (autorégulateur) avec traslation de l'assise (op. SLYJ) et basculant centré A19. Fauteuil visiteurs uniquement tournant, avec dossier haut et moyen (coque entière), avec piètement "Spider" ou piètement à 5 branches ou socle plat en acier inox (uniquement avec dossier moyen) complétée par le retour automatique "TORNA" (non réglable en hauteur). Accoudoirs et piètements en aluminium finition polie (LU) ou vernie noire (N).

Direktionsdrehessel mit Kopfstütze, hoher oder mittelhoher Rückenlehne erhältlich. Mechaniken: Synchronmechanik SY109 (selbstregulierend) mit Schiebesitz (op. SLYJ) und Wippmechanik mit zentralem Drehpunkt A19. Besuchersessel nur als Drehessel mit hoher oder mittlerer Rückenlehne (einteilige Sitzschale) erhältlich. 5-Stern-Fußkreuz Ø 68 cm und 4-Stern-Fußkreuz Ø 70 cm mit der Bezeichnung "Spider", in der Ausführung poliert (LU) oder schwarz (N). Edelstahlsteller Ø 50 in Kombination mit der Rückholmechanik "TORNA" (nicht höhenverstellbar).

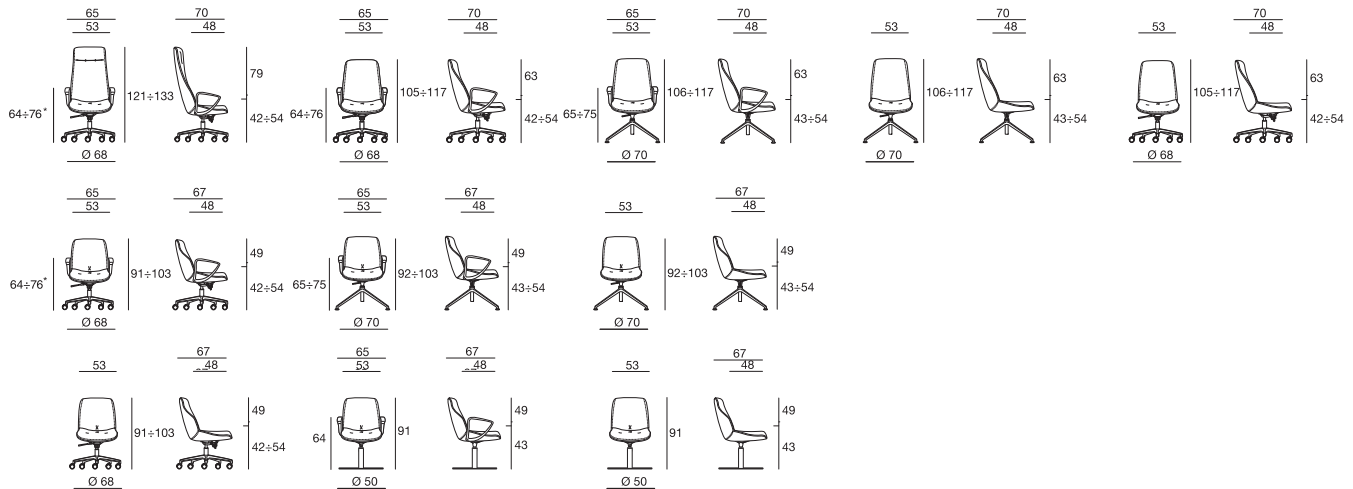

* quota media per basi girevoli | medium quote for swivel base | cote moyenne pour piètements tournants | Durchschnittswert für Drehkreuze

DAMA design Favaretto & Partners

Serie direzionale disponibile con poggiatesta, schienale alto o basso: completa la gamma una poltroncina ospiti di dimensioni più piccole. Serie proposta con tappezzeria Plain oppure con variante Strip (con cuciture verticali nella zona lombare). Meccanismi: Synchro SLYD con traslazione sedile per poltrona con poggiatesta e schienale alto, o oscillante CT1 per poltrona schienale alto e basso. Struttura fissa Ø 35 mm a 4 gambe con ruote posteriori abbinata a poltrona alta e bassa. Direzionale girevole con base in alluminio a 5 razze, o base a 5 razze con finitura lucida (LU). Poltroncina ospiti in versione fissa, con base a slitta o 4 gambe, oppure girevole con base in alluminio a 4 razze, o base a 5 razze con finitura lucida (LU). Finiture strutture fisse: cromata (CR), nera (N) o bianca (BI).

Executive series with headrest, and high or low backrest: a small size chair for guests complete the series. This series is suggested with Plain upholstery (without front stitchings) or Strip (with front stitchings in the lumbar area). Mechanisms are: Synchro SLYD with sliding seat device combined with the headrest or high back chairs; or with central tilt CT1 mechanism combined with high and low backrest chairs. 4-leg frame with rear wheels made of Ø 35 mm steel tube combined to the high and low backrest. Executive chair equipped with Ø 68 cm 5-star aluminum base with polished (LU) or black laquered (N) finishing. Visitor's small size chair in fixed version with sled base or 4-leg frame, or in swivel version with cross aluminum base or 5-star base both in polished finishing (LU) only. Fixed frames finishing in chrome (CR), black (N) or white (BI).

Serie direction disponible avec tête, dossier haut ou bas. Un petit fauteuil visiteurs de plus petites dimensions complète la gamme. Série proposée avec tapiserie Plain ou Strip (avec coutures verticales dans la zone lombaire). Mécanismes: Synchro SLYD avec traslation d'assise pour fauteuil avec tête et dossier haut, ou basculant CT1 pour fauteuil avec dossier haut ou bas. Structure fixe Ø 35 mm à 4 pieds avec roulettes arrière pour le fauteuil avec dossier haut ou bas. Fauteuil direction tournant avec piètement en aluminium à 5 branches Ø 68 cm avec finition polie (LU) ou noire (N). Petit fauteuil visiteurs en version fixe, avec piètement luge ou à 4 pieds, ou tournant avec piètement en aluminium à 4 branches ou avec piètement à 5 branches en finition polie (LU). Finitions structures fixes: chromée (CR), noire (N) ou blanche (BI).

Direktionsdrehessel mit Kopfstütze, hoher oder niedriger Rückenlehne. Ein Besuchersessel mit kleineren Abmessungen rundet die Produktfamilie ab. Diese Serie wird mit der Polsterung Plain oder in der Version Strip (mit vertikaler verlaufenden Steppnähten im Bereich der Lordosenstütze) angeboten. Mechaniken: Synchronmechanik SLYD mit Schiebesitz für die Version mit Kopfstütze und hoher Rückenlehne, sowie Wippmechanik CT1 für die Version mit hoher und niedriger Rückenlehne. Fixes Gestell mit vier Beinen Ø 35 mm, mit Rollen an den hinteren Beinen sowohl für den hohen, wie für den niedrigen Sessel. Direktionsdrehessel mit 5-Stern-Fußkreuz aus Aluminium Ø 68 cm in der Ausführung glanzpoliert (LU) oder schwarz (N). Besuchersessel mit Freischwinger- oder Vierbein Gestell in den Ausführungen: verchromt (CR), schwarz (N) oder weiß (BI), oder als Drehstuhl mit 4- oder 5-Stern-Fußkreuz aus Aluminium glanzpoliert (LU).

STRIP

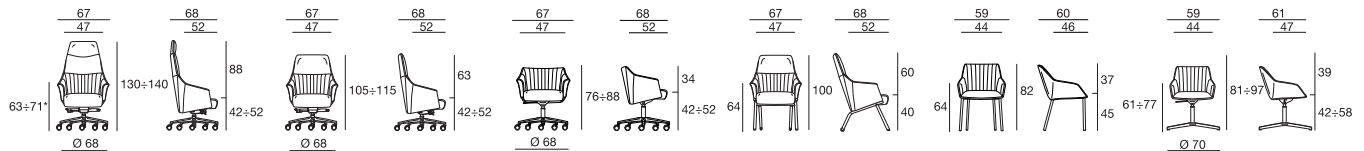

* quota media per basi girevoli | medium quote for swivel base | cote moyenne pour piètements tournants | Durchschnittswert für Drehkreuze

PLAIN

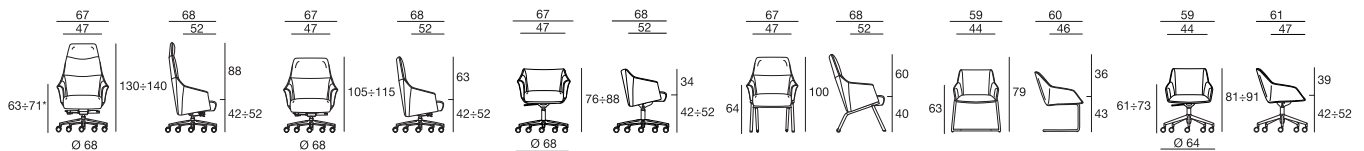

* quota media per basi girevoli | medium quote for swivel base | cote moyenne pour piètements tournants | Durchschnittswert für Drehkreuze

MODÀ design Studio Omega

p. 20

Serie direzionale disponibile con poggiatesta e schienale alto. Completa la gamma una poltroncina ospiti di dimensioni più piccole. Serie proposta con tappezzeria Office (con cuciture orizzontali) oppure Style (tappezzeria capitonné). Caratteristica della serie, sia direzionale che ospiti, è l'imbottitura che è realizzata da stampo in un solo pezzo con la parte strutturale portante in acciaio.

La poltrona direzionale è proposta con due meccanismi: il Synchro SYM e l'oscillante a fulcro avanzato AX7; base in alluminio a 5 razze Ø 68 cm finitura lucida (LU). Serie ospiti girevole disponibile con base a 5 razze o base piana in acciaio Inox, oppure a 4 razze in alluminio, tutte con finitura lucida (LU); versione fissa con base "piramidale", finitura cromata (CR).

Executive series with headrest, and high backrest. A small size chair for guests complete the series.

This series is suggested with "Office" upholstery (with horizontal stitchings) or Strip (with capitonné upholstery). The main characteristic of this series is the one shell body, which is molded with injected foam in one mold. The executive chair is suggested with two mechanisms: Synchro SYM and AX7 knee tilt, combined with a Ø 68 cm 5-star polished aluminum base (LU). Visitor's chairs are suggested in a fixed version with pyramidal 4-leg steel frame, or in a swivel version with a 5-star and a 4-star aluminum base both in polished finishing (LU).

Série direction disponible avec tête et dossier haut. Un petit fauteuil visiteurs de plus petites dimensions complète la gamme. Série proposée avec tapissérie Office (avec coutures horizontales) ou Style (tapissérie capitonné). La série, direction ou visiteurs, est caractérisée par son rembourrage réalisé en un moulage d'une seule pièce, sur une structure portante en acier.

Le fauteuil direction est proposé avec deux mécanismes: le mécanisme synchrone SYM et le basculant décalé AX7; le piètement est en aluminium à 5 branches Ø 68 cm avec finition polie (LU). Série visiteurs tournante disponible avec piètement à 5 branches ou socle plat en acier inox, ou encore avec piètement à 4 branches en aluminium, tous avec finition polie (LU); version fixe avec piètement "pyramidal", finition chromée (CR).

Direktionsdrehessel mit Kopfstütze oder mit hoher Rückenlehne erhältlich. Ein Besuchersessel mit kleineren Abmessungen rundet die Produktfamilie ab. Diese Serie wird mit der Polsterung Office (mit horizontalen Steppnähten) oder Style (Punktsteppung capitonné) angeboten. Charakteristisch für diese Serie, sowohl für die Drehessel, wie für die Besuchersessel ist der Polsteraufbau, der aus einem einteiligen Formschauteil und einer tragenden Stahlkonstruktion besteht. Die Direktionsessel werden mit zwei verschiedenen Mechaniken angeboten: Synchronmechanik SYM und Wippenmechanik mit vorgelagertem Gelenkpunkt AX7, 5-Stern-Fußkreuz aus Aluminium Ø 68 cm glanzpoliert (LU). Die Besuchersessel als Drehessel sind mit 5- oder 4-Stern-Fußkreuz aus Aluminium oder mit flacher Fußplatte aus Edelstahl, alle in der Ausführung glanzpoliert, erhältlich. Die Version ohne Drehfunktion hat ein Pyramidenförmiges Stahlgestell, verchromt (CR).

OFFICE

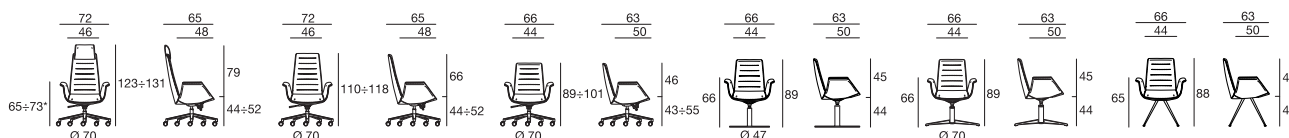

* quota media per basi girevoli | medium quote for swivel base | cote moyenne pour piètements tournants | Durchschnittswert für Drehkreuze

STYLE

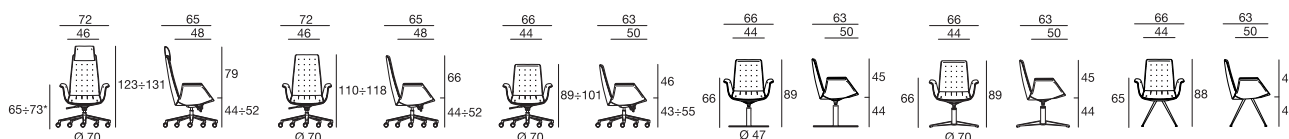

* quota media per basi girevoli | medium quote for swivel base | cote moyenne pour piètements tournants | Durchschnittswert für Drehkreuze

MODE design Studio Omega

p. 24

Serie direzionale proposta con tappezzeria Plain oppure con variante Strip (con cuciture orizzontali nella zona lombare). Schienale in tre dimensioni: alto con poggiatesta, alto e medio. Meccanismi: Synchro SYM, oscillante a fulcro avanzato AX7, ed elevazione a gas della seduta per le versioni con schienale medio. I braccioli, con la struttura in acciaio sempre cromata, sono di 3 tipi: BT con poggia braccia tappezzato, BA in acciaio (non disponibile con il Synchro SYM), BP con poggia braccia in Poliuretano rigido. Base a 5 razze Ø 70 cm in alluminio finitura lucida, proposta con ruote frenate/gommatae da Ø 65 mm o piedini.

Executive series available with Plain (without front stitches) or Strip (with front horizontal stitches in the chair front upholstery). Three types of backrest are available: high with headrest, high and mid-height backrest. Mechanisms: Synchro SYM, AX7 knee-tilt mechanism and seat height adjustment by gaslift for medium backrest versions. The armrests, featuring a chrome steel frame, are available in three versions: BA (not available with Synchro SYM), BT with upholstered arm cap or BP with rigid Polyurethane arm cap. The Ø 70 five-star base polished aluminium is available with Ø 65 mm braked/rubber castors or glides.

Série direction proposée avec tapissérie Plain (sans coutures avant) et Strip (avec coutures horizontales à l'avant de la chaise). Trois dimensions de dossier: haut avec tête, haut et moyen. Trois mécanismes: Synchro SYM, basculant décalé AX7 et réglage hauteur assise avec cartouche à gaz pour les versions avec dossier moyen. Les accoudoirs, avec structure en acier toujours chromée, sont de trois types: BT avec manchette tapissée, BA en acier (non disponible avec le Synchro SYM), BP avec manchette en Polyuréthane rigide. Le piètement 5 branches Ø 70 cm, en aluminium poli, est proposé avec roulettes freinées souples pour sol dur de Ø 65 mm ou avec des patins.

Direktionsdrehessel in den Polsterungsvarianten Plain oder Strip (horizontale Steppnähte im Lumbalbereich). Rückenlehne mit drei Größen: Hoch mit Kopfstütze, hoch oder mittelhoch. Mechaniken: Synchronmechanik SYM, Wippenmechanik mit vorgelagertem Gelenkpunkt AX7. Die Versionen mit mittelhocher Rückenlehne sind zudem mit der reinen Gaslift-Höhenverstellung verfügbar. Die Armlehnen aus Stahl, immer verchromt, werden in drei Ausführungen angeboten: BT mit gepolsterter Armauflage, BA Stahl (nicht einsetzbar mit Mechanik Synchro SYM) BP mit Armauflage aus kompaktem Polyurethan. 5-Stern-Fußkreuz aus Aluminium Ø 70 cm glanzpoliert (LU), wahlweise mit gebremsten Doppelrollen mit weichem Laufing Ø 65 mm oder mit Gleitern.

STRIP

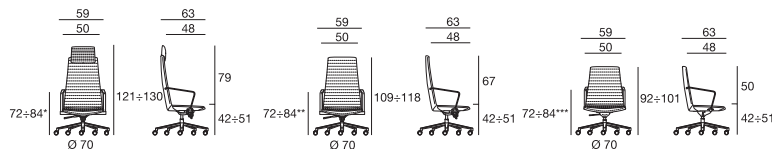

PLAIN

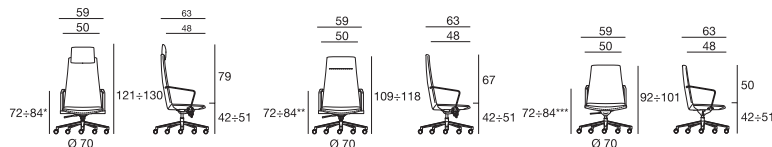

* quota media con braccioli BT
medium quote with BT armrests
cote moyenne avec accoudoirs BT
Durchschnittswert mit Armlehnen BT

** quota media con braccioli BP
medium quote with BP armrests
cote moyenne avec accoudoirs BP
Durchschnittswert mit Armlehnen BP

*** quota media con braccioli BA
medium quote with BA armrests
cote moyenne avec accoudoirs BA
Durchschnittswert mit Armlehnen BA

Serie direzionale e semidirezionale proposta in tre versioni: Win-S, (versione SLIM), Win-I (versione IMBOTTITA), Win-R (versione RETE). Proposta con meccanismo Synchro SYR o SLYR (con traslatore di seduta) nelle versioni con poggiatesta e schienale alto: schienale alto e medio solo con alzo a gas per ospiti girevoli. Sono disponibili 3 tipi di braccioli: in acciaio (7AC), in acciaio-Poliuretano (8PY) e regolabili a 4 vie (4BH). Struttura metallica con finiture in colore nero (N) o alluminio (VA) oppure cromata (CR). Base in alluminio finitura lucida (LU) o in colore grigio alluminio (VA), oppure in alluminio colore nero (N), con ruote o piedini.

Executive series available in three versions: Win-S (SLIM version), Win-I (PADDED version) and Win-R (MESH version), with Synchro SYR or SLYR (with seat slide device) mechanism are available only for version with headrest or high back, high and medium back swivel chair for visitors only with gaslift. 3 types of armrests are available 7AC in steel, 8PY in steel-Polyurethane, 4BH 4-way adjustable. Black colour (N), aluminium colour (VA) or chromed (CR) metal frame finishing. Polished (LU) or grey aluminium colour (VA) or aluminium base black colour (N) with castors or glides.

Série direction et semi-direction proposée en trois versions: Win-S (version SLIM), Win-I (version REBOURRÉE), et Win-R (version RÉVILLE). Proposée avec mécanisme Synchro SYR ou SLYR (avec déplacement vers l'avant de l'assise) dans les versions avec tête et haut dossier; dossier haut et moyen uniquement avec vérin à gaz, fauteuils tournants pour visiteurs. 3 types d'accoudoirs sont disponibles: en acier (7AC), en acier-Polyuréthane (8PY) et réglables à 4 voies (4BH). Structure de couleur noire (N) ou aluminium (VA) ou chromée (CR). Piètement en aluminium poli (LU) ou de couleur gris aluminium (VA), ou en aluminium de couleur noire (N), avec roulettes ou patins.

Serie für den Direktional- und Semidirektionalbereich in drei Versionen: Win-S (Slim), Win-I (gepolstert) und Win-R (Mit Netzbespannung). Die Versionen mit Kopfstütze und hoher Rückenlehne sind mit der Synchronmechanik SYR oder SLYR (Schiebesitz), jene mit hoher und mittelhoher Rückenlehne als Besucherdrehstuhl sind hingegen nur mit Gaslift-Höhenverstellung ausgestattet. Es stehen drei Armlehnenmodelle zur Auswahl: Flachstahl (7AC), Stahl-Polyurethan (8PY) und 4-fach verstellbar (4BH). Gestellteile aus Stahl können schwarz (N) oder aluminiumgrau (VA) beschichtet sowie verchromt (CR) sein. Aluminium-Fußkreuze glanzpoliert (LU) oder schwarz (N) oder aluminiumgrau beschichtet (VA), mit Rollen oder Gleitern.

SLIM

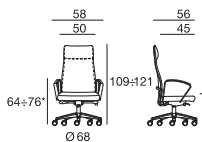

IMBOTTITA

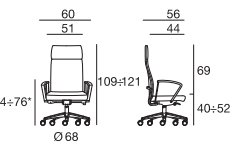

RETE

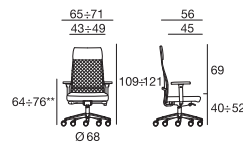

* quota con braccioli 7AC
quote with 7AC armrests
cote avec accoudoirs 7AC
Wert mit Armlehnen 7AC

* quota con braccioli 8PY
quote with 8PY armrests
cote avec accoudoirs 8PY
Wert mit Armlehnen 8PY

** quota con braccioli 4BH abbassati
4BH armrests quote with lowered position
cote avec accoudoirs 4BH abaissés
Wert mit Armlehnen 4BH (unterste Stufe)

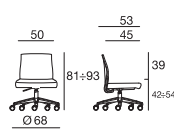
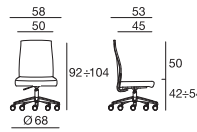
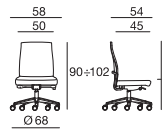

ADA 1 Act Design

La versione direzionale è proposta con poggiatesta e con schienale alto, mentre la versione ospiti girevole è proposta con schienale alto e medio. I braccioli e lo schienale formano un corpo unico, mentre il sedile è indipendente. Il meccanismo sincronizzato SLYR ha la traslazione del sedile di serie, mentre come optional viene proposto il poggiaerani regolabile in altezza A1-ADH. Sul retro dello schienale è posto un decoro, cromato o nero. È disponibile la variante "PLUS", con la tappezzeria arricchita.

Executive series with headrest and high backrest, while for swivel visitor's available with high and medium backrest. Arms and backrest form a single unit, while the seat is independent. Synchronized SLYR mechanism equipped as standard with front sliding seat device. The A1-ADH adjustable lumbar support is an option. A decorative insert, chromed or black, is placed on the rear of the backrest. Ada 1 is also available in a version called Plus, with enriched upholstery.

Série direction proposée avec tête et dossier haut, pour chaise tournante pour visiteurs disponible avec dossier haut et moyen. Comme standard mécanisme Synchro SLYR avec déplacement antérieur de l'assise. L'appui lombaire réglable en hauteur A1-ADH est suggéré comme option. Les accoudoirs et le dossier forment un seul bloc, l'assise est indépendante. Une décoration chromée ou noire est placée à l'arrière du dossier. Ada 1 est aussi disponible en version Plus, avec tapisserie enrichie.

Die Version als Direktionsstuhl ist mit Kopfstütze und mit hoher Rückenlehne erhältlich, der Besucher-Drehstuhl ist hingegen mit hoher und mittelhoher Rückenlehne erhältlich. Rückenlehne und Armlehnen bestehen aus einer einzigen Formschale, während die Sitzfläche eigenständig ist. Die Synchronmechanik SLYR ist serienmäßig mit Schiebesitzfunktion ausgestattet. Optional kann eine höhenverstellbare Lumbalstütze A1-ADH eingesetzt werden. Auf der Rückseite der Rückenlehne ist ein Dekorelement in den Ausführungen verchromt oder schwarz angebracht. Weiter steht die Variante „PLUS“, eine Aufwertung der Polsterung, zur Verfügung.

ADA 1

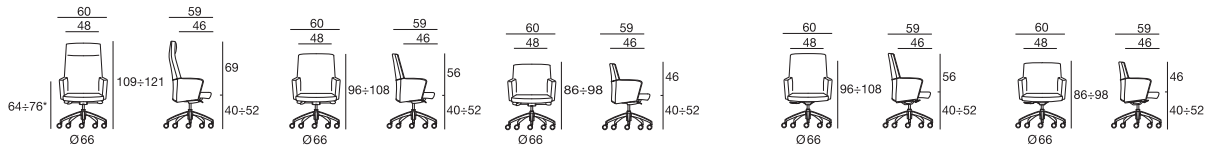

* quota media per basi girevoli | medium quote for swivel base | cote moyenne pour piétements tournants | Durchschnittswert für Drehkreuze

visitors

ADA 1 PLUS



* quota media per basi girevoli | medium quote for swivel base | cote moyenne pour piétements tournants | Durchschnittswert für Drehkreuze

visitors

La versione direzionale è proposta con poggiatesta e con schienale alto, mentre per ospiti girevole è disponibile con schienale alto e medio. Braccioli in acciaio di forma chiusa (6AC) o regolabili in altezza (4BH). Il meccanismo sincronizzato SLYR ha la traslazione del sedile di serie, mentre come optional viene proposto il poggiaerani regolabile in altezza LX-ADH. Sul retro dello schienale è posto un decoro cromato o nero. Ada LX è disponibile con la variante PLUS, con la tappezzeria arricchita.

Executive series suggested with headrest and high backrest, while the swivel visitor's chair is suggested with high and medium backrest. The executive version is suggested with Synchro SLYR mechanism equipped as standard with front sliding seat. The LX-ADH adjustable lumbar support is an option. A decorative insert, chromed or black, is placed on the rear part of the backrest. Closed shape fixed arms (6AC) or high adjustable arms (4BH) are available. Ada LX is also available in a version called PLUS, with enriched upholstery.

Série direction proposée avec tête et dossier haut tandis que le dossier haut et moyen est disponible pour les chaises tournantes pour visiteurs. Version de direction proposée avec mécanisme Synchro SLYR avec déplacement frontal de l'assise. L'appui lombaire réglable en hauteur LX-ADH est suggéré comme option. Une décoration, chromée ou noire, est placée à l'arrière du dossier. Accoudoirs en acier de forme fermée (6AC) ou réglables en hauteur (4BH). Ada LX est aussi disponible en version PLUS, avec tapisserie enrichie.

Die Version als Direktionssessel ist mit Kopfstütze und mit hoher Rückenlehne erhältlich, der Besucher-Drehstuhl ist hingegen mit hoher und mittelhoher Rückenlehne erhältlich. Ring-Armlehnen aus Stahl (6AC) oder höhenverstellbare Armlehnen (4BH). Die Synchronmechanik SLYR ist serienmäßig mit Schiebeseitzfunktion ausgestattet. Optional kann eine höhenverstellbare Lumbalstütze LX-ADH eingesetzt werden. Auf der Rückseite der Rückenlehne ist ein Dekorelement in den Ausführungen verchromt oder schwarz angebracht. Weiters steht die Variante "PLUS", eine Aufwertung der Polsterung, zur Verfügung.

LX

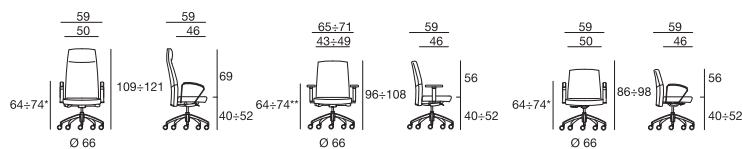

LX PLUS

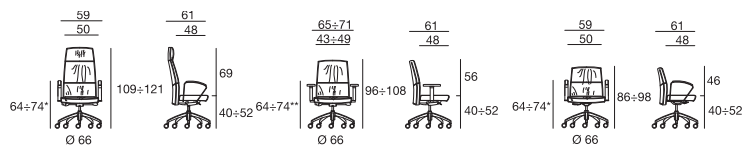

* quota con braccioli 7AC
quote with 7AC armrests
cote avec accoudoirs 7AC
Wert mit Armlehnen 7AC

** quota con braccioli 4BH abbassati
4BH armrests quote with lowered position
cote avec accoudoirs 4BH abaissés
Wert mit Armlehnen 4BH (unterste Stufe)

* quota con braccioli 7AC
quote with 7AC armrests
cote avec accoudoirs 7AC
Wert mit Armlehnen 7AC

SAX design UT Sesta

p. 36

Famiglia composta da: Sax Rete con schienale in rete, Sax Air con schienale dotato di "membrana" (rete portante + imbottito, accoppiati) e Sax 8, con schienale imbottito (retro con carter in plastica). Le tre serie si differenziano dallo schienale, mentre il sedile, i meccanismi (Synchro SY24 e autoregolante PSY6), i braccioli e la base, sono gli stessi per tutte e tre. Lo schienale di Sax 8 è regolabile in altezza, mentre quello di Sax Rete e Sax Air è regolabile in altezza ed è dotato di fascia lombare regolabile in altezza. Le serie Sax Rete e Sax Air sono proposte anche in versione WHITE (colore bianco RAL 9010). Base a 5 razze in alluminio pressofuso Ø 68 cm finitura nera (N), lucida (LU), bianca (BI10) e grigio alluminio (VA). Ogni razza è dotata di placche con grip anti-sciolo. Sedia ospiti con base a slitta, struttura cromata (CR).

Family of task chairs consisting of: Sax Rete with mesh backrest, Sax Air with "membrane" fitted into the backrest (bearing mesh + covering, coupled) and Sax 8, with padded backrest (plastic outer shell). The three versions are distinguished by the backrest, while they all have the same seat, mechanisms (Synchro SY24 and self-adjusted PSY6), armrests and base. The Sax 8 backrest is height adjustable, while Sax Rete and Sax Air are height-adjustable and are also fitted with height-adjustable lumbar support. Sax Rete and Sax Air are suggested also in WHITE version (RAL 9010 white colour). 5-star aluminum base Ø 68 cm, finishing in black (N), polished aluminum (LU), white (BI10) and grey aluminum colour (VA). All the ray is equipped with anti-slip grip plates.

Famille de chaises de travail composée de: Sax Rete avec dossier en résille, Sax Air avec dossier muni d'une "membrane" (Réseille portante + rembourrage, accouplés) et Sax 8, avec dossier tapissé (avec carter en plastique à l'arrière). Les trois séries se différencient par leur dossier, alors que l'assise, les mécanismes (Synchro SY24 et auto-ajusté PSY6), les accoudoirs et le piètement sont les mêmes pour toutes les trois. Le dossier de Sax 8 est réglable en hauteur, celui de Sax Rete et de Sax Air est réglable en hauteur mais il possède en plus une bande lombaire réglable en hauteur. Sax Rete et Sax Air, sont proposés aussi en version WHITE (en coloris blanc RAL 9010). Piètement à 5 branches Ø 68 cm, finition en noir (N), aluminium poli (LU) et gris aluminium couleur (VA). Tout le rayon est équipé de plaques antidérapantes.

Funktionsdrehstuhl-Familie in drei Versionen, die sich in der Ausführung der Rückenlehne unterscheiden: Sax Rete mit Netz-Rücken, Sax Air mit Membran-Rücken (Netz als Trägerschicht mit Aufpolsterung) und Sax 8 mit gepolsterter Rückenlehne (Rückseite mit Kunststoffschale). Die Mechaniken (Synchro SY24 und PSY6-selbstregulierend), die Armlehnen und das Grundgestell sind bei allen Versionen gleich. Bei der Version Sax 8 ist die Rückenlehne höhenverstellbar, während bei den Versionen Sax Air und Sax Rete die Rückenlehne höhenverstellbar und zusätzlich mit einer höhenverstellbaren Lumbalstütze bestückt ist. Die Versionen Sax Air und Sax Rete sind auch in der Ausführung WHITE (Farbe Weiß, RAL 9010) lieferbar. 5-fach-Drehkreuz Ø 68 cm aus Aluminium-Druckguss schwarz (N), weiß (BI) oder aluminiumgrau (VA) beschichtet oder glanzpoliert (LU). Die Kreuzausleger sind mit einer Schutzplatte aus Kunststoff mit rutschfester Oberfläche versehen. Besucherstühle mit Freischwingergestell, verchromt (CR).

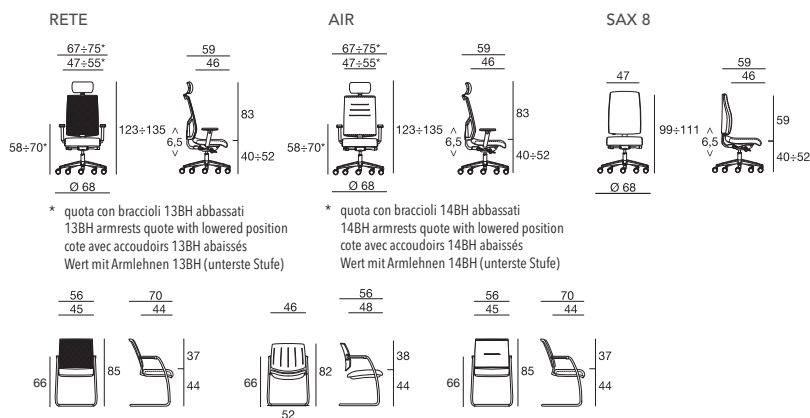

SAX 24 design UT Sesta

p. 42

Sax 24 fa parte della famiglia Sax. Sax 24 è una sedia da lavoro concepita per essere destinata all'uso di 24h/giorno (3x8h), con garanzia di 2 anni (per 220 giorni lavorativi, nei 3 turni di lavoro), oppure, per un uso di 8h/giorno (per 220 giorni lavorativi anno), con garanzia di 5 anni. Sax 24 è disponibile solo in alcuni rivestimenti, che hanno caratteristiche all'usura elevate (+ di 100.000 cicli Martindale). Sax 24 inoltre, è stata concepita in modo che ogni suo componente sia separabile, quindi facilmente riciclabile (grado di riciclabilità del 100% - in versione senza braccioli e senza poggiatesta). Base a 5 razze in alluminio pressofuso Ø 68 cm finitura nera (N), lucida (LU) e grigio alluminio (VA). Ogni razza è dotata di placche con grip anti-sciolo.

Sax 24 is part of the Sax family. The Sax 24 task chair is designed for 24 h use (3x8 h) and comes with a two-year warranty (220 working days a year, in 3 work shifts), or a five-year warranty for 8 h use (220 working days a year). Sax 24 is only available with the more hard-wearing coverings (in excess of 100,000 Martindale cycles). What's more, Sax 24 was conceived so that each of its parts can be disassembled, making it easy to recycle (100% recyclable - version without armrests and without headrest). 5-star aluminum base Ø 68 cm, finishing in black (N), polished aluminum (LU) and grey aluminum colour (VA). All the ray is equipped with anti-slip grip plates.

Sax 24 fait partie de la famille Sax. Sax 24 est une chaise de travail conçue pour une utilisation 24h/24 (3x8h), avec garantie de 2 ans (pour 220 jours ouvrables, sur 3 roulements), ou encore, pour une utilisation de 8h par jour (pour 220 jours ouvrables), avec garantie de 5 ans. Sax 24 n'est disponible qu'avec certains revêtements, qui possèdent une résistance à l'usure élevée (+ de 100.000 cycles Martindale). Sax 24 a aussi été conçue de manière à ce que chacun de ses composants soit séparable, et donc facilement recyclable (taux de recyclage 100% - en version sans accoudoirs et sans tête). Piètement à 5 branches Ø 68 cm, finition en noir (N), aluminium poli (LU) et gris aluminium couleur (VA). Tout le rayon est équipé de plaques antidérapantes.

Sax 24 gehört zur Familie Sax und ist ein Funktionsdrehstuhl für den 24-Stunden-Einsatz (3x8 Stunden/Tag) konzipiert. Die Produktgarantie beträgt bei ständigem Einsatz (3x8 h und 220 Arbeitstagen/Jahr) 2 Jahre, und bei Standard-Einsatz (8 Stunden 220 Tage/Jahr) 5 Jahre. Sax 24 ist nur mit einer Auswahl an Bezugstoffen mit besonderen Haltbarkeitsmerkmalen (mehr als 100.000 Scheuertouren nach Martindale) erhältlich. Außerdem wurde SAX24 so angefertigt, dass alle Bestandteile, einschließlich Mechanismus, voneinander getrennt werden können und deshalb leicht wieder verwertbar sind. (100% recyclefähig - Ausführung ohne Armlehnen und ohne Kopfstütze). 5-fach-Drehkreuz Ø 68 cm aus Aluminium-Druckguss schwarz (N) oder aluminiumgrau (VA) beschichtet oder glanzpoliert (LU). Die Kreuzausleger sind mit einer Schutzplatte aus Kunststoff mit rutschfester Oberfläche versehen.

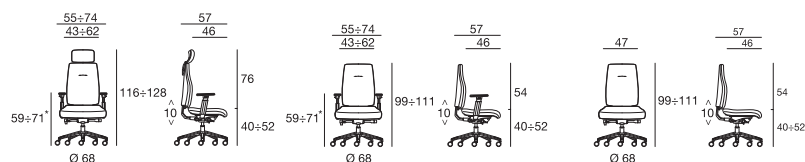

WIN TASK Act Design

p. 44

Serie con schienale in un'unica altezza (H 50 cm da sedile) proposta in 3 versioni: Win-S (versione SLIM), Win-I (versione Imbottita) e Win-R (versione RETE). Proposta solo con meccanismo Synchro SLYR, che incorpora la traslazione del sedile, e con regolazione lombare ADH di serie. Sono disponibili 3 tipi di braccioli: in acciaio (7AC), in Poliuretano (8PY) e regolabili a 4 vie (4BH). Struttura metallica con finiture colore nero (N) o alluminio (VA) oppure cromata (CR). Base in alluminio pressofuso Ø 68 cm finitura nera (N), lucida (LU) e grigio alluminio (VA). Ogni razza è dotata di placche con grip anti-scivolo.

Series with one height backrest (H 50 cm, from the seat) available in three versions: Win-S (Slim version), Win-I (Padded version) and Win-R (Mesh version), all available with ADH standard lumbar support. Available only Synchro SLYR mechanism, is suggested with 3 types of arms: 7AC in steel, 8PY in Polyurethane, 4BH 4-way adjustable. Black colour (N), aluminium colour (VA) or chromed (CR) frame finishing. 5-star aluminium base Ø 68 cm, finishing in black (N), polished aluminium (LU) and grey aluminium colour (VA). All the ray is equipped with anti-slip grip plates.

Série avec dossier d'une seule hauteur (H 50 cm, de l'assise) proposée en trois versions: Win-S (Slim version), Win-I (version Rembourrée) et Win-R (version Résille), toutes disponibles avec réglage lombaire ADH standard. Proposée uniquement avec mécanisme Synchro SLYR. 3 types d'accoudoirs sont disponibles, en acier (7AC), en Polyuréthane (8PY) et réglables à 4 voies (4BH). Structure de couleur noire (N) ou aluminium (VA) ou chromée (CR). Piètement à 5 branches Ø 68 cm, finition en noir (N), aluminium poli (LU) et gris aluminium couleur (VA). Tout le rayon est équipé de plaques antidérapantes.

Funktionsdrehstuhlserie mit einer einzigen Rückenlehnenhöhe (50 cm ab Sitzfläche) in drei Versionen: Win-S (Slim), Win-I (gepolstert) und Win-R (mit Netzbespannung). Bestückt mit einer Synchronmechanik SLYR, serienmäßig mit Schiebeseit und Lumbalstützeinstellung ADH. Es stehen drei Armlehnenmodelle zur Auswahl: Flachstahl (7AC), Stahl-Polyurethan (8PY) und 4-fach verstellbar (4BH). Gestellteile aus Stahl in der Ausführung schwarz (N) oder aluminiumgrau (VA) beschichtet sowie verchromt (CR). 5-fach-Drehkreuz Ø 68 cm aus Aluminium-Druckguss schwarz (N) oder aluminiumgrau (VA) beschichtet oder glanzpoliert (LU). Die Kreuzausleger sind mit einer Schutzplatte aus Kunststoff mit rutschfester Oberfläche versehen.

SLIM

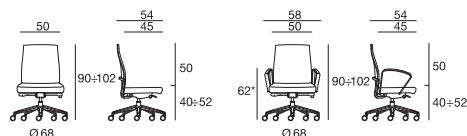

IMBOTTITA

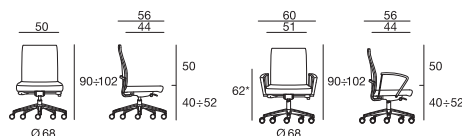

* quota con braccioli 7AC
quote with 7AC armrests
cote avec accoudoirs 7AC
Wert mit Armlehnen 7AC

* quota con braccioli 8PY
quote with 8PY armrests
cote avec accoudoirs 8PY
Wert mit Armlehnen 8PY

RETE

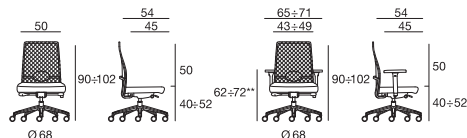

** quota con braccioli 4BH abbassati
4BH armrests quote with lowered position
cote avec accoudoirs 4BH abaissés
Wert mit Armlehnen 4BH (unterste Stufe)

CALIBRA LIGHT design Studio Omega

p. 46

Sedia operativa con struttura e braccioli proposti in due colori: nero NE/09 e grigio chiaro GR/35, corrispondente alla tabella RAL 7035. Al colore nero e grigio chiaro della struttura si possono abbinare indifferentemente 9 colori di schienale (CM71, AR75, RO32, AZ52, BL47, GR19, GR35, AN29, NE09). Il meccanismo in dotazione è il Contatto Permanente PCS4 con comandi laterali, dotato di anti-shock e manopola per la regolazione della tensione. Base Ø 70 cm in Nylon, nera o grigia, oppure in alluminio con finitura lucida, ruote Ø 50 mm frenata/gommata per pavimenti duri. Braccioli fissi (6BRA, 6BGR) oppure regolabili (11BH, 11BHGR). Come sedia ospiti, è proposta in abbinamento la serie Carina.

Task chair suggested with lower part of the body (seat, mechanism, gaslift cover, base and castors) and arms in two colours - black ref. NE/09 and light grey ref. GR/35 (corresponding to RAL 7035 card). The backrest is available in 9 colours, (CM71, AR75, RO32, AZ52, BL47, GR19, GR35, AN29, NE09). The series is equipped with PCS4 Permanent Contact mechanism with side levers, tension adjustment and anti-shock device. Ø 70 cm 5 star base is in Nylon or in aluminium with polished finishing, Ø 50 mm braked/rubber castor for hard floors. Fixed Polypropylene arms (6BRA, 6BGR) or height adjustable (11BH, 11BHGR). Carina series is matching well with Calibra Light.

Chaise opérateur avec structure inférieure et accoudoirs proposés en deux coloris - la noire réf. NE/09 et le gris clair GR/35 (correspondent au tableau RAL 7035). Le dossier est disponible dans 9 coloris (CM71, AR75, RO32, AZ52, BL47, GR19, GR35, AN29, NE09). La série est proposée avec mécanisme contact permanent PCS4 avec leviers latéraux, réglage tension et anti-shock. Piètements sièges tournants Ø 70 cm en Nylon (NY) ou bien en aluminium poli (LU), roulette Ø 50 mm freinée et souple pour sols durs. Accoudoirs xes (6BRA, 6BGR) ou bien réglables en hauteur (11BH, 11BHGR). La série Carina est suggérée comme siège visiteurs.

Funktionsdrehstuhl: Die Gestellteile und Armlehnen sind in zwei Farben erhältlich: schwarz NE/09 und hellgrau GR/34 (RAL 7035). Zu beiden Ausführungsvarianten passend stehen 9 Farben für die Rückenlehne zur Auswahl (CM71, AR75, RO32, AZ52, BL47, GR19, GR35, AN29, NE09). Serienmäßig mit Permanentkontakt-Mechanik PCS4 mit seitlichen Bedienhebeln, Anti-Shock-Funktion und Drehknopf für die Einstellung der Gegendruckstärke. Drehkreuz Ø 70 cm aus Nylon, schwarz oder grau oder alternativ aus Aluminium glanzpoliert (LU), weiche, gebremste Doppelrollen Ø 50 mm für harte Böden. Armlehnen fix (6BRA, 6BGR) oder verstellbar (11BH, 11BHGR). Als passender Besucherstuhl wird die Modellreihe CARINA angeboten.

PP

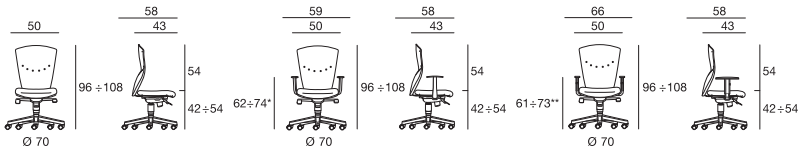

IMPP

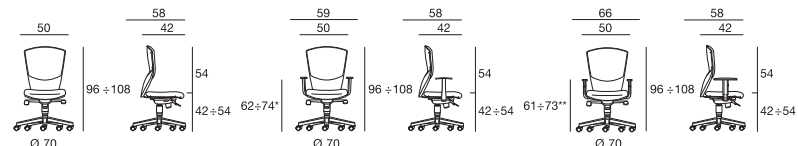

* quota con braccioli 6BRA
quote with 6BRA armrests
cote avec accoudoirs 6BRA
Wert mit Armlehnen 6BRA

** quota con braccioli 11BH abbassati
11BH quote with lowered position
cote avec accoudoirs 11BH abaissés
Wert mit Armlehnen 11BH (unterste Stufe)

FRILL / NOFRILL Act Design

p. 50 / p. 54

Serie polifunzionale con scocca in Polipropilene (100% vergine) proposta in 8 colori per FRILL e 7 per NOFRILL (il rosso non è disponibile), di cui avio e antracite disponibili in versione ignifuga (CL1). Le sedie fisse dispongono di un carter sotto il sedile per facilitarne l'impilabilità disponibile in tre colori (silver, bianco, antracite). Disponibile in versione fissa con base a 4 gambe (sedia e sgabello) o con base skid e sia girevoli con base Spider, a croce e a 5 razze o su trave. La struttura a 4 gambe in faggio naturale ha la parte metallica con finitura solo cromata, mentre le altre strutture fisse metalliche hanno finitura nera (N), cromata (CR) o bianca (BI). Per le versioni girevoli con base a 5 razze o base "spider" di forma piramidale la finitura è solo lucida.

Multi function series with one-shell seat made in Polypropylene (100% vergin material) suggested in 8 colours for FRILL and 7 for NOFRILL (red colour is not available), two of which in each version (navy and anthracite) are available in fire-retardant CL1 (ITA) version. Fixed chairs are equipped with a under seat pad for a easy stacking which is available in three colours (silver, white, anthracite). The fixed frames available are: a 4-leg frame for chair and stool, a skid base, a 4-leg in wood combined with a metal frame (in chrome finishing only), while the swivel versions are suggested with a 4- leg Spider base, with a cross base and with a 5-star base, all these with polished finishing. The fixed frames are available in black (N) or chrome (CR) or white (BI) finishing.

Série multifonctions avec coque en Polypropylène (100% vierge) proposée en 8 couleurs pour FRILL et 7 pour NOFRILL (le rouge n'est pas disponible), avec bleu aviation et anthracite disponibles en version ignifuge (CL1). Les chaises fixes sont équipées d'un carter sous l'assise, qui facilite l'empilage, disponible en trois couleurs (silver, blanc, gris foncé). Disponible soit en version fixe avec piètement à 4 pieds (chaise et tabouret) ou avec piètement luge, soit en version tournante avec piètement araignée, en croix et à 5 branches ou encore sur poutre. La structure à 4 pieds en hêtre naturel a sa partie métallique uniquement en finition chromée, les autres structures fixes métalliques ont une finition noire (N), chromée (CR) ou blanche (BI). Les versions tournantes avec piètement à 5 branches ou araignée de forme pyramidale n'ont qu'une finition polie.

Mehrzweckstuhl mit Sitzschale aus Polypropylen (100 Reinmaterial) in 8 Farben bei FRILL und 7 bei NOFRILL (rot ist hier nicht verfügbar), wobei die Farbe anthrazit und weiß-avio auch in Feuerschutz-Ausführung (KL1, M2) erhältlich ist. Die Stühle mit festem Gestell sind mit einer speziellen Unterschale an der Sitzschale versehen, die die Stapelbarkeit verbessert. Diese ist in 3 Farben verfügbar (Silber, weiß, anthrazit). Feststehend mit Vierbeingestell (Stuhl und Hocker) und mit Kufengestell (SKID), als Drehstuhl mit Pyramiden-Sternfuß sowie 4- oder 5-Stern-Fußkreuz und als Sitzbanksystem erhältlich. Beim Vierbeingestell aus Buche Natur sind die Metallteile ausschließlich verchromt, während die anderen Gestellvarianten des feststehenden Stuhls schwarz (N) oder weiß (BI) beschichtet sowie verchromt (CR) sein können. Drehstühle mit 5-fach Drehkreuz und Pyramidengestell "Spider" haben immer ein verchromtes Gestell.

FRILL

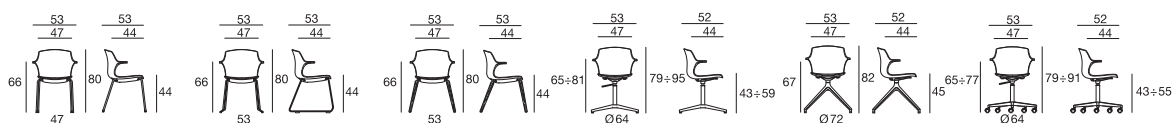

NOFRILL

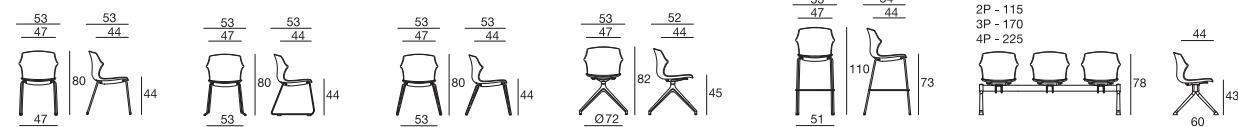

Q2 design Studio Omega

p. 56

Serie polifunzionale per conferenza, riunioni, ospiti e attesa, proposta con varie strutture, sia fisse che girevoli. La serie Q2 si presenta in più varianti: "W" monoscocca in faggio multistrato finitura naturale oppure tinto (sbiancato FB, wengé WE), "WIM" monoscocca con retro in faggio naturale oppure tinto e fronte tappezzato con cuciture orizzontali, "IM" monoscocca completamente rivestita, con fronte caratterizzato da cuciture orizzontali. La finitura delle strutture a 4 gambe o skid con o senza braccioli, è in colore nero (N), bianco (BI), cromata (CR) e grigio alluminio (VA). Le versioni girevoli invece sono disponibili solo con struttura cromata (CR) abbinata a basamenti con finitura lucida (LU).

Multi function chair for conference, meeting, waiting, suggested in different versions, both in swivel and fixed versions. Based on the one shell seat made in multi-layer beechwood, the variants are: "W" one shell with natural finishing (F) or stained in bleached (FB) finishing or in wengé (WE) finishing. "WIM" one shell with rear in natural beechwood F or stained in FB or WE and fully upholstered front panel with horizontal stitchings. "IM" fully upholstered shell with front horizontal stitchings. The frame finishing of the fixed frames, with or without arms, is in black colour (N), or in white (BI), or chromed (CR) or in grey aluminium (VA). Swivel versions are available with chromed frame only (CR) and with polished aluminum bases (LU).

Série multifonctions pour conférences, réunions, visiteurs et attente, proposée avec différentes structures, fixes ou tournantes. La série Q2 se présente en plusieurs versions: "W" monocoque en hêtre multiplis avec finition naturelle, ou teinté (blanchi FB, wengé WE), "WIM" monocoque avec rétro en hêtre naturel ou teinté et devant caractérisé par ses coutures horizontales, "IM" monocoque entièrement revêtu, avec devant caractérisé par ses coutures horizontales. La finition des structures à 4 pieds ou luge, avec ou sans accoudoirs, est de couleur noire (N), blanche (BI), chromée (CR) ou gris aluminium (VA). Les versions tournantes ne sont disponibles qu'avec structure chromée (CR) associée à piètements en finition polie (LU).

Mehrzweck-Objektstuhl für den Besucher-, Warte-Konferenz-, und Gästebereich geeignet. Mit verschiedenen Gestellvarianten, sei es als feststehender Stuhl oder als Drehstuhl, verfügbar. Es stehen mehrere Ausführungsvarianten zur Auswahl: "W" einteilige Schale aus Buchen-Schichtholz Natur, oder gebeizt (Kalkeffekt FB, Wenge WE), "WIM" die einteilige Schale aus Buchen-Schichtholz Natur, oder gebeizt ist an der Frontseite mit einer Polsteraufdoppelung mit horizontalen Steppnähten versehen, "IM" die einteilige Schale ist rundum gepolstert wobei die Frontseite durch horizontale Steppnähte charakterisiert ist. Die Vierbein- oder Kufengestelle SKID, mit oder ohne Armlehnen, können schwarz (N) aluminiumgrau (VA) oder weiß (BI) beschichtet, sowie verchromt (CR) sein. Die drehbaren Gestelle sind hingegen ausschließlich verchromt (CR) in Kombination mit glanzpolierten (LU) Drehkreuzen verfügbar.

W

WIM

IM

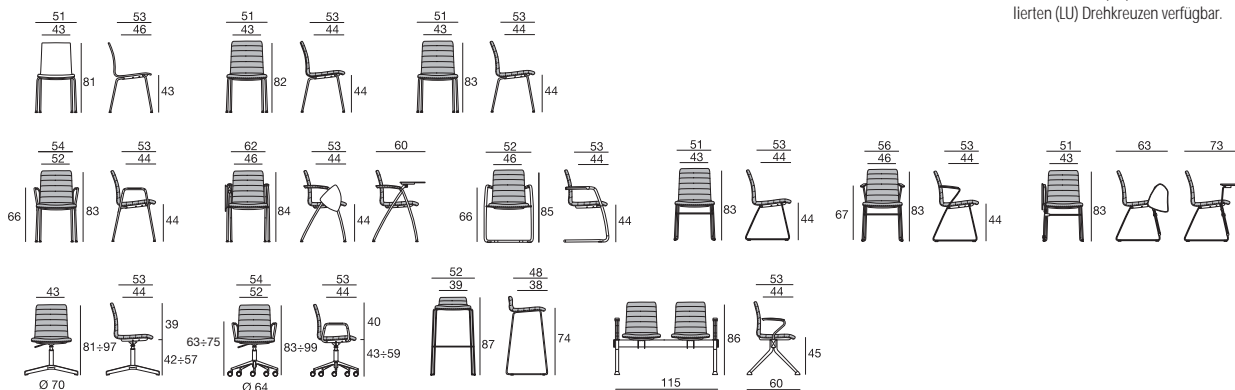

Q-44 XL design Studio Omega

p. 68

Ampliamento di gamma della serie Q-44 con l'inserimento di uno schienale più alto, definito XL, proposto in versione RETE o AIR. La versione XL mantiene tutte le caratteristiche strutturali e di componentistica della serie Q-44 ed è proposta nelle varianti RETE (tipo N) e AIR (membrana tappezzata in ogni rivestimento a cartella).

La cornice dello schienale XL, che è realizzata in Nylon, è proposta nei colori grigio GR19, Nero NE09 e crema CM71, mentre la finitura della struttura è: colore nero (N) grigio alluminio (VA) e cromata (CR).

Expansion of the Q-44 series with the insertion of a new higher backrest, defined XL, which is suggested in RETE and AIR version. The XL version maintains all the characteristics, components and finishing of the Q-44 standard backrest. The XL version is suggested with backrest in RETE (mesh, N type) and AIR (inner mesh with foam coupled with any kind of covering). The XL backrest's frame is made in Nylon, suggested in grey colour (GR19), black colour (NE09) and white cream (CM71). Metal frame finishing: black (N), chromed (CR) and grey aluminium (VA).

La série Q-44 enrichit sa gamme en introduisant un dossier plus haut, défini XL, proposé en version RETE ou AIR. La version XL, qui maintient toutes les caractéristiques de la structure et des composants de la série Q-44, est proposée dans les variantes RETE (type N) et AIR (membrane tapissée dans tous les revêtements du nuancier). Le cadre du dossier XL est en Nylon, proposé en couleur grise (GR19), en couleur noire (NE09) et en crème (CM71), finition de la structure: noire (N) gris aluminium (VA) et chromée (CR).

Programmerweiterung der Serie Q-44 durch eine höhere Rückenlehne, XL bezeichnet. Diese ist in den Ausführungsvarianten RETE (Typ N) und AIR (Membranrücken, mit allen Bezugstoffen aus dem Sortiment beziehbar) verfügbar und behält alle Eigenschaften der Serie Q-44 in Bezug auf Aufbau und Komponenten bei. Der Rückenlehnrahmen XL aus Nylon ist in den Farben grau (GR19), schwarz (NE09) und Creme (CM71), während das Gestell in den Ausführungen: schwarz (N) oder aluminiumgrau (VA) beschichtet und verchromt (CR) erhältlich ist.

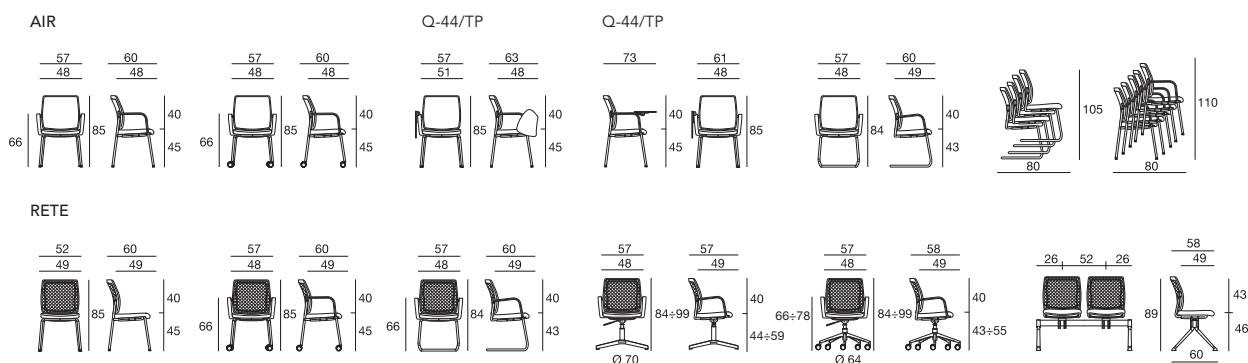

Q-44 design Studio Omega

p. 72

Serie polifunzionale proposta in 4 varianti: "PP" sedile e schienale in Polipropilene, "IMPP" sedile tappezzato e schienale in Polipropilene, "IM" sedile e schienale tappezzati, "RETE" sedile tappezzato e schienale in rete. Serie proposta in più versioni: sedia a 4 gambe con piedini o su ruote, base a slitta, girevole con base a 5 razze o a 4 razze, oppure su trave: tutte disponibili con o senza braccioli. I braccioli possono essere in Polipropilene o in acciaio, quest'ultimo disponibile anche con scrittoio antipanico. Finitura della struttura metallica: colore nero (N), cromato (CR) o colore grigio alluminio (VA).

Multi function series suggested in four variants: "PP" with seat and backrest in Polypropylene, "IMPP" with upholstered seat and backrest in Polypropylene, "IM" with seat and backrest upholstered, "RETE" with upholstered seat and backrest in mesh (N type). The Q44 series is suggested in several versions: 4-leg on glides or castors, sled base, swivel on 5-star or 4 star base, or on beam. The standard arms are in Polypropylene or in oval steel tube with or without writing tablet. Metal frame finishing: black (N), chromed (CR) and grey aluminium (VA).

Série multifonctions proposée en 4 versions: "PP" assise et dossier en polypropylène, "IMPP" assise tapissée et dossier en Polypropylène, "IM" assise et dossier tapissés, "RETE" assise tapissée et dossier en résille. Structure proposée en plusieurs versions: à 4 pieds avec patins ou sur roulettes, piètement luge, tournante sur piètement à 5 branches ou à 4 branches, ou encore sur poutre; toutes les versions sont disponibles avec ou sans accoudoirs. Les accoudoirs peuvent être en polypropylène ou en acier, ce dernier est disponible avec tablette écriteiro anti panique. Finition de la structure métallique: noire (N) gris aluminium (VA) et chromée (CR).

Mehrzweck-Objektstuhlserie in 4 Versionen: "PP" Sitzund Rückenschale aus Polypropylen, "IMPP" Sitz gepolstert und Rückenschale aus Polypropylen, "IM" Sitz und Rücken gepolstert, "RETE" Sitz gepolstert und Rückenlehne netzbespannt. Die Serie wird in mehreren Modellvarianten angeboten: Vierbeinstuhl mit Gleitern oder Rollen, Freischwingergestell, Drehstuhl mit 4- oder 5-Stern-Fußkreuz, oder als Traversenbank. Alle sind mit oder ohne Armlehnen verfügbar. Die Armlehnen können aus Polypropylen oder aus Stahl gefertigt sein. Die Stahlarmlehnen sind auch mit Schreibtishtar mit Anti-Panik-Funktion erhältlich. Ausführung der Metallgestelle: Schwarz (N) oder aluminiumgrau (VA) beschichtet oder verchromt (CR).

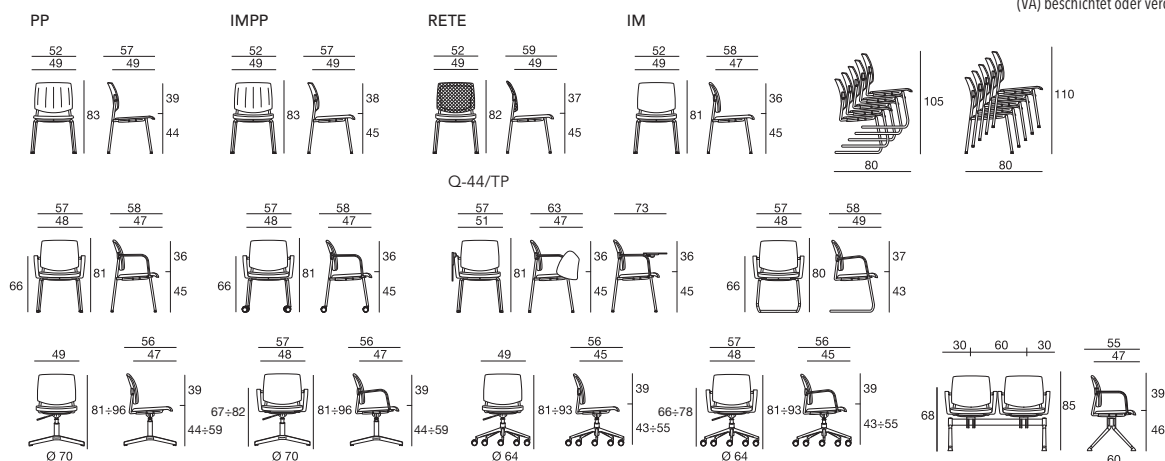

Q-EASY XL design Studio Omega

p. 74

Ampliamento di gamma della serie Q-Easy con l'inserimento di uno schienale più alto, definito XL, proposto in versione RETE o AIR. La versione XL mantiene tutte le caratteristiche strutturali e di componentistica della serie Q-Easy ed è proposta nelle varianti RETE (tipo N) e AIR (membrana tappezzata in ogni rivestimento a cartella). La cornice dello schienale XL, che è realizzata in Nylon, è proposta nei colori grigio GR19, nero NE09 e crema CM7. Finitura della struttura: colore nero (N), bianco (BI) corrispondente al RAL 9010, grigio alluminio (VA) e cromata (CR).

Expansion of the Q-Easy series with the insertion of a new higher backrest, defined XL, which is suggested in RETE and AIR version. The XL version maintains all the characteristics, components and finishing of the Q-Easy standard backrest. The XL version is suggested with backrest in RETE (mesh, N type) and AIR (inner mesh with foam coupled with any kind of covering). The XL backrest's frame is made in Nylon, suggested in grey colour (GR19), black colour (NE09) and white cream (CM71). Metal frame finishing: black (N), white (BI) correspondent to RAL 9010, chromed (CR) and grey aluminium (VA).

La série Q-EASY enrichit sa gamme en introduisant un dossier plus haut, défini XL, proposé en version RETE ou AIR. La version XL, qui maintient toutes les caractéristiques de la structure et des composants de la série Q-EASY, est proposée dans les variantes RETE (type N) et AIR (membrane tapissée dans tous les revêtements du nuancier). Le cadre du dossier XL est en Nylon, proposé en couleur grise (GR19), en couleur noire (NE09) et en crème (CM71), finition de la structure métallique: noir (N), blanc (BI) correspondant au RAL 9010, gris aluminium (VA) ou chromée (CR).

Programmerweiterung der Serie Q-EASY durch eine höhere Rückenlehne, XL bezeichnet. Diese ist in den Ausführungsvarianten RETE (Typ N) und AIR (Membranrücken, mit allen Bezugstoffen aus dem Sortiment beziehbar) verfügbar und behält alle Eigenschaften der Serie Q-EASY in Bezug auf Aufbau und Komponenten bei. Der Rückenlehnrahmen XL aus Nylon ist in den Farben grau (GR19), schwarz (NE09) und Creme (CM71), während das Gestell in den Ausführungen schwarz (N) weiß RAL 9010 (BI) aluminiumgrau (VA) und verchromt (CR) lieferbar ist.

AIR

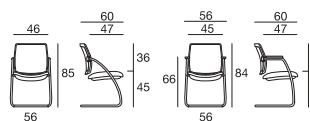

RETE

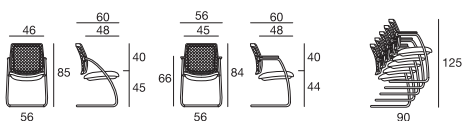

Q-EASY design Studio Omega

p. 78

Sedia per attesa, ospiti, riunioni, con base a slitta impilabile con o senza braccioli. Il sedile è sempre tappezzato, mentre lo schienale è proposto in 3 varianti: "IMPP" Polipropilene in 3 colori, "RETE" con rete proposta in 7 colori, "IM" sedile e schienale tappezzati. Struttura con finitura cromata (CR) o nera (N) o in colore grigio alluminio (VA). Per facilitare l'impilabilità il sedile è dotato di un carter in Polipropilene, di colore antracite.

Stacking chair on cantilever base with or without arms, for waiting areas, visitors and meeting. The chair, which has the seat always upholstered, it's available with backrest in three versions: "IMPP" Polypropylene 3 colours, "IM" completely upholstered and "RETE" mesh 7 colours. Frame available in chrome (CR), black colour (N) or grey aluminium colour (VA). The under seat is protected by a Polypropylene pad in anthracite colour.

Chaise pour attente, visiteurs, réunions, avec piètement luge empilable avec ou sans accoudoirs. L'assise est toujours tapissée, alors que le dossier est proposé en 3 versions: "IMPP" Polypropylène en 3 couleurs, "RETE" avec résille proposée en 7 couleurs, "IM" assise et dossier tapissés. Structure avec finition chromée (CR), noire (N) ou de couleur gris aluminium (VA). Pour faciliter l'empilage, l'assise est équipée d'un carter en Polypropylène de couleur anthracite.

Stapelbarer Objektstuhl mit Freischwingergestell, mit oder ohne Armlehnen für den Besucher-, Warte-, Konferenz-, und Gästebereich geeignet. Der Sitz ist immer gepolstert, während die Rückenlehne in 3 Versionen verfügbar ist: "IMPP" aus Polypropylen in 3 Farben, "RETE" netzbespannt in 7 Farben "IM" Sitz und Rücken gepolstert. Gestell Schwarz (N) oder aluminiumgrau (VA) beschichtet oder verchromt (CR). Um die Stapelung zu erleichtern ist der Stuhl mit einer speziellen Schale unter der Sitzschale versehen.

IMPP

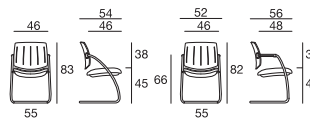

IM

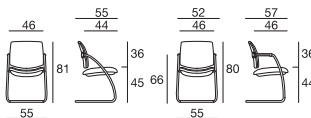

RETE

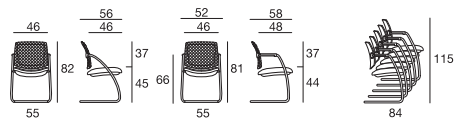

Q-FOUR XL design Studio Omega

p. 80

Ampliamento di gamma della serie Q-Four con l'inserimento di uno schienale più alto, definito XL, proposto in versione RETE o AIR. La versione XL mantiene tutte le caratteristiche strutturali e di componentistica di Q-Four ed è proposta nelle varianti RETE (tipo N) e AIR (membrana tappezzata in ogni rivestimento a cartella). La cornice dello schienale XL, che è realizzata in Nylon, è proposta nei colori grigio GR19, nero (NE09) e crema (CM71), mentre la finitura della struttura è: colore nero (N), grigio alluminio (VA) e cromata (CR).

Expansion of the Q-Four series with the insertion of a new higher backrest, defined XL, which is suggested in RETE and AIR version. The XL version maintains all the characteristics, components and finishing of the Q-44 standard backrest. The XL version is suggested with backrest in RETE (mesh, N type) and AIR (inner mesh with foam coupled with any kind of covering). The XL backrest's frame is made in Nylon, suggested in grey colour (GR19), black colour (NE09) and white cream (CM71). Metal frame finishing: black (N), grey aluminium (VA) and chromed (CR).

La série Q-Four enrichit sa gamme en introduisant un dossier plus haut, défini XL, proposé en version RETE ou AIR. La version XL, qui maintient toutes les caractéristiques de la structure et des composants de la série Q-Four, est proposée dans les variantes RETE (type N) et AIR (membrane tapissée dans tous les revêtements du nuancier). Le cadre du dossier XL est en Nylon, proposé en couleur grise (GR19), en couleur noire (NE09) et en crème (CM71), finition de la structure: noire (N), gris aluminium (VA) et chromée (CR).

Programmerweiterung der Serie Q-Four durch eine höhere Rückenlehne, XL bezeichnet. Diese ist in den Ausführungsvarianten RETE (Typ N) und AIR (Membranrücken, mit allen Bezugstoffen aus dem Sortiment beziehbar) verfügbar und behält alle Eigenschaften der Serie Q-Four in Bezug auf Aufbau und Komponenten bei. Der Rückenlehnrahmen XL aus Nylon ist in den Farben grau (GR19), schwarz (NE09) und Creme (CM71), während das Gestell in den Ausführungen: schwarz (N), aluminiumgrau (VA) oder verchromt (CR) erhältlich ist.

AIR

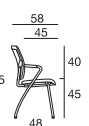
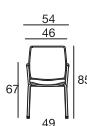
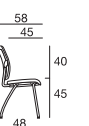
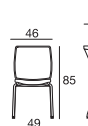

RETE

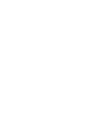
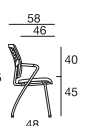
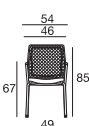
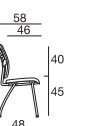
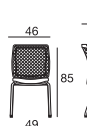

Q-FOUR design Studio Omega

p. 84

Sedia polifunzionale impilabile per attesa, ospiti, riunioni. Il sedile è sempre tappezzato, mentre lo schienale è proposto in 3 varianti: "IMPP" Polipropilene in 3 colori, "RETE" con rete proposta in 7 colori, "IM" schienale tappezzato con fodera amovibile. Struttura proposta in colore nero (N), cromata (CR) o in colore grigio alluminio (VA). La versione con braccioli ha il poggiatesta realizzato in Polietilene, proposto in 3 colori CM71 crema, GR19 grigio e NE09 nero. Per facilitare l'impilabilità il sedile è dotato di un carter in Polipropilene, di colore antracite.

Multi function series for meeting, waiting areas, as visitor chair. The seat is always upholstered, while the backrest is suggested in three variants: "IMPP" in Polypropylene in three colours, "IM" with seat and backrest upholstered, "RETE" with mesh in 7 colours. Metal frame finishing: black (N), chromed (CR) and grey aluminium (VA). The version with arms has a Polyethylene arm-pad, available in 3 colours: cream (CM71), gray (GR19) and black (NE09). In order to facilitate the stacking, the seat is equipped with a Polypropylene under seat pad in anthracite colour.

Chaise multifonctions empilable pour attente, visiteurs, réunions. L'assise est toujours tapissée, alors que le dossier est proposé en 3 versions: "IMPP" Polypropylène en 3 couleurs, "IM" dossier tapissé déhoussable, "RETE" avec résille proposée en 7 couleurs. Structure proposée de couleur noire (N), chromée (CR) ou de couleur gris aluminium (VA). La version avec accoudoirs possède une manchette en Polyéthylène, proposé en 3 couleurs: crème (CM71), gris (GR19) et noir (NE09). Pour faciliter l'empilage, l'assise est équipée d'un carter en polypropylène de couleur anthracite.

Stapelbarer Mehrzweck-Objektstuhl für den Besucher-, Warte- Konferenz-, und Gästebereich geeignet. Der Sitz ist immer gepolstert, während die Rückenlehne in 3 Versionen verfügbar ist: "IMPP" aus Polypropylen in 3 Farben, "IM" Rückenschale gepolstert mit abnehmbarem Bezug, "RETE" netzbespannt in 7 Farben. Gestell Schwarz (N) oder aluminiumgrau (VA) beschichtet oder verchromt (CR). Die Variante mit Armlehnen hat eine Armauflage aus Polyethylen, in 3 Farben verfügbar: Creme (CM71), grau (GR19) und schwarz (NE09). Um die Stapelung zu erleichtern ist der Stuhl mit einer speziellen Schale unter der Sitzschale versehen.

IMPP

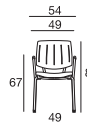
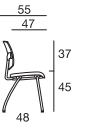
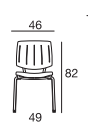

IM

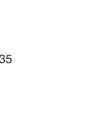
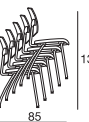
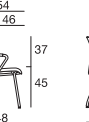
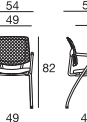
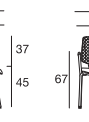
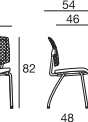
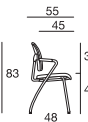
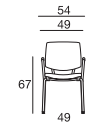
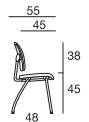
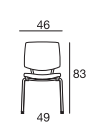

Q-GO XL design Studio Omega

p. 86

Ampliamento di gamma della serie Q-GO con l'inserimento di uno schienale più alto, definito XL, proposto in versione RETE o AIR. La versione XL mantiene tutte le caratteristiche strutturali e di componentistica di Q-GO ed è proposta nelle varianti RETE (tipo N) e AIR (membrana tappezzata in ogni rivestimento a cartella). La cornice dello schienale XL, che è realizzata in Nylon, è proposta nei colori grigio GR19, nero (NE09) e crema (CM71), mentre la finitura della struttura è colore nero (N), grigio alluminio (VA) e cromata (CR).

Expansion of the Q-GO series with the insertion of a new higher backrest, defined XL, which is suggested in "RETE" and "AIR" version. The XL version maintains all the characteristics, components and finishing of the Q-GO standard backrest. The XL version is suggested with backrest in "RETE" (mesh, N type) and "AIR" (inner mesh with foam coupled with any kind of covering). The XL backrest's frame is made in Nylon, suggested in grey colour (GR19), black colour (NE09) and white cream (CM71). Metal frame finishing: black (N), chromed (CR) and grey aluminium (VA).

La série Q-GO enrichit sa gamme en introduisant un dossier plus haut, défini XL, proposé en version RETE ou AIR. La version XL, qui maintient toutes les caractéristiques de la structure et des composants de la série Q-GO, est proposée dans les variantes RETE (type N) et AIR (membrane tapissée dans tous les revêtements du nuancier). Le cadre du dossier XL est en Nylon, proposé en couleur grise (GR19), en couleur noire (NE09) et en crème (CM71), finition de la structure: noire (N) gris aluminium (VA) et chromée (CR).

Programmerweiterung der Serie Q-GO durch eine höhere Rückenlehne, XL bezeichnet. Diese ist in den Ausführungsvarianten RETE (Typ N) und AIR (Membranrücken, kann mit allen Bezugstoffen aus dem Sortiment bezogen werden) verfügbar und behält alle Eigenschaften der Serie Q-GO in Bezug auf Aufbau und Komponenten bei. Der Rückenlehnenrahmen XL aus Nylon ist in den Farben grau (GR19), schwarz (NE09) und Creme (CM71), während das Gestell in den Ausführungen: schwarz (N), aluminiumgrau (VA) oder verchromt (CR) erhältlich ist.

AIR

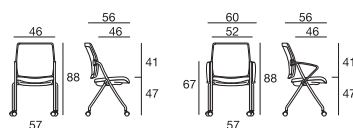

TP/EU

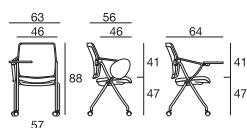

RETE

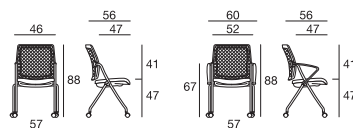

TP/US

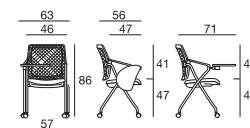

Q-GO design Studio Omega

p. 90

Sedia polivalente con o senza braccioli, con sedile sempre tappezzato e schienale proposto in 3 varianti: "IMPP" Polipropilene in 3 colori, "IM" schienale tappezzato con fodera amovibile, "RETE" con rete proposta in 7 colori. Q-GO è dotata di sedile ribaltabile, e parcheggiabile frontalmente ed è impilabile. La serie è disponibile con due tipi di scrittoio: versione EU (Europa), con tavoletta di forma ovale in Polipropilene dotata di ribaltamento antipanico, e versione US (Usa) con grande tavoletta porta laptop realizzata in Polietilene oppure in HPL (optional). La struttura, che è disponibile con piedini o ruote, è proposta con finitura in colore nero (N), cromata (CR) o in colore grigio alluminio (VA). Per facilitare l'impilabilità il sedile è dotato di un carter in Polipropilene, di colore antracite.

A multifunctional 4-leg chair with or without arms. The seat is always upholstered, while the backrest is suggested in three variants: "IMPP" Polypropylene in 3 colours, "IM" completely upholstered, and "RETE" with mesh in 7 colours. Q-GO is equipped with a folding seat for row storage and it's stackable. Q-GO comes with or without armrests and with two types of writing tablet: a European with oval shape with anti-panic system, and USA type having a bigger size to carry a laptop USA (just front-stacking). The frame is available with glides or castors and with black (N), chromed (CR) or aluminium grey (VA) finish. In order to facilitate the stacking, the seat is equipped with a Polypropylene under seat pad in anthracite colour.

Chaise polyvalente avec ou sans accoudoirs, avec assise toujours tapissée et dossier proposé en 3 versions: "IMPP" Polypropylène en 3 couleurs, "IM" assise et dossier tapissés, et "RETE" avec résille proposée en 7 couleurs. Q-GO est équipée d'une assise rabattable pour être rangée en ligne et elle est empilable. La série est disponible avec deux types de tablettes écrites: version EU (Europe), avec tablette de forme ovale en polypropylène rabattable anti panique, et version US (Usa) avec grande tablette supportant un ordinateur portable, réalisée en polyéthylène ou en stratifié HPL (option). La structure, qui est disponible avec patins ou roulettes, est proposée avec finition de couleur noire (N), chromée (CR) ou de couleur gris aluminium (VA). Pour faciliter l'empilage, l'assise est équipée d'un carter en polypropylène de couleur anthracite.

Mehrzweck-Objektstuhl mit oder ohne Armlenken. Der Sitz ist immer gepolstert, während die Rückenlehne in 3 Versionen verfügbar ist: "IMPP" aus Polypropylen in 3 Farben, "IM" Sitz und Rücken gepolstert, "RETE" netzbespannt in 7 Farben. Q-GO hat eine aufklappbare Sitzschale und kann einerseits horizontal ineinandergereiht (horizontal stapelbar) sowie vertikal gestapelt werden. Es stehen zwei Schreibrettmodelle zur Auswahl: Version EU (Europa) mit ovalförmiger Platte aus Polypropylen mit Anti-Panik-Funktion und US (USA) mit großer Platte aus Polypropylen oder HPL (Optional), für Laptop geeignet. Das Gestell kann mit Gleitern oder Rollen bestückt werden und ist in den Ausführungen: Schwarz (N) oder aluminiumgrau (VA) beschichtet oder verchromt (CR) lieferbar. Um die Stapelung zu erleichtern ist unter der Sitzschale eine spezielle Schutzschale angebracht.

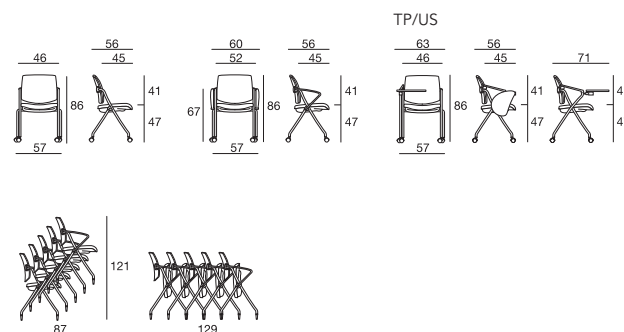
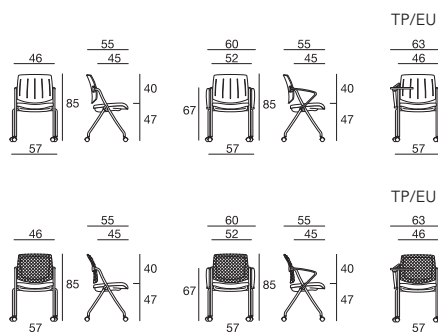

EASY-GO design Studio Omega

p. 92

Sedia polivalente per conferenza, riunioni, ospiti, proposta in due varianti: "PP" sedile e schienale in Polipropilene disponibili in 7 colori, "IMPP" sedile tappezzato e schienale in Polipropilene in 7 colori. La sedia, con struttura a 4 gambe disponibili con ruote o piedini, è dotata di sedile ribaltabile, è impilabile e parcheggiabile frontalmente. Proposta con 2 tipi di braccioli (corto 07 e chiuso 09), è disponibile con due tipi di scrittoio: versione EU (Europa), con tavoletta di forma ovale in Polipropilene dotata di ribaltamento anti-panico, e versione US (Usa) con grande tavoletta porta lap-top realizzata in Polietilene oppure in HPL (optional). Finitura della struttura in colore nero (N), cromata (CR) o in colore grigio alluminio (VA). Per facilitare l'impilabilità il sedile è dotato di un carter in Polipropilene, di colore antracite.

A multifunctional chair for conference, meeting, visitor, with or without arms, suggests in two variants: "PP" with seat and backrest in Polypropylene in 7 colours, or "IMPP" with upholstered seat and Polypropylene backrest in 3 colours. Q-GO is a 4-leg chair with flip-up seat available with glides or castors, it's equipped with a folding seat for row storage and it's stackable. It comes with or without arms and with two types of writing tablet: a European with oval shape with anti-panic system, and USA type made in Polyethylene or in HPL (option) having a bigger size to carry a laptop USA (just front-stacking). The frame is available with black (N), chromed (CR) or aluminium grey (VA) finish. In order to facilitate the stacking, the seat is equipped with a Polypropylene under seat pad in anthracite colour.

Chaise polyvalente pour conférences, réunions, visiteurs, proposée en deux versions: "PP" assise et dossier en Polypropylène disponible en 7 couleurs, "IMPP" assise tapissée et dossier en polypropylène en 7 couleurs. La chaise, avec structure à 4 pieds disponibles avec roulettes ou patins, est équipée d'une assise rabattable pour être rangée en ligne et elle est empilable. Proposée avec 2 types d'accoudoirs (court 07 et fermé 09), elle est disponible avec deux types de tablettes écrites: version EU (Europe), avec tablette de forme ovale en Polypropylène rabattable anti panique, et version US (Usa) avec grande tablette supportant un ordinateur portable, réalisée en Polyéthylène ou en stratifié HPL (option). Finition de la structure: noire (N), chromée (CR) ou de couleur gris aluminium (VA). Pour faciliter l'empilage, l'assise est équipée d'un carter en Polypropylène de couleur antracite.

Mehrzweck-Objektstuhl für den Besucher-, Konferenz-, und Gästebereich, in zwei Versionen verfügbar: "PP" Sitz und Rückenschale aus Polypropylen, in 7 Farben und "IMPP" Sitz gepolstert und Rückenschale aus Polypropylen, in 7 Farben. Der Stuhl mit Vierbeinergestell, mit Rollen oder Gleitern, hat eine aufklappbare Sitzschale und kann einerseits horizontal ineinander gereiht (horizontal stapelbar) sowie vertikal gestapelt werden. Es stehen zwei Armlehnenmodelle (kurz 07, oder Ringförmig 09) und zwei Schreibrettmodelle zur Auswahl: Version EU (Europa) mit ovalförmiger Platte aus Polypropylen mit Anti-Panik-Funktion und US (USA) mit großer Platte aus Polypropylen oder HPL (Optional), für Laptop geeignet. Das Gestell ist in den Ausführungen schwarz (N) oder aluminiumgrau (VA) beschichtet oder verchromt (CR) lieferbar. Um die Stapelung zu erleichtern ist unter der Sitzschale eine spezielle Schutzschale angebracht.

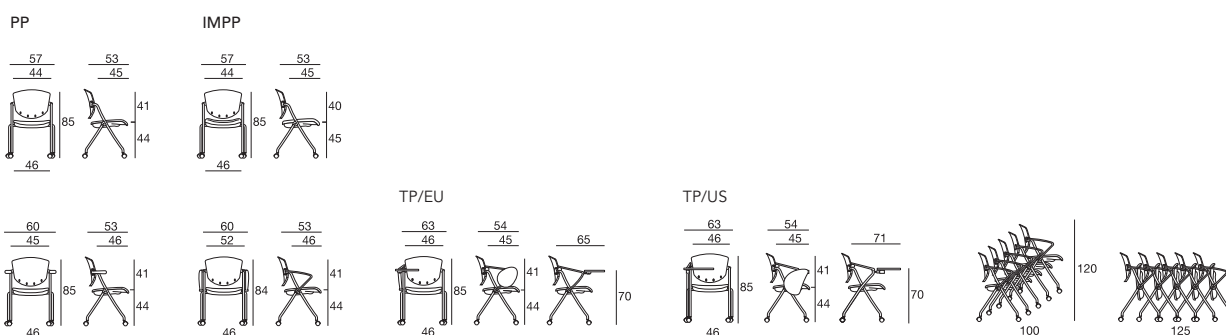

CARINA design Studio Omega

p. 96

Serie polifunzionale con cocca in Polipropilene in 14 colori di cui 8 disponibili in CL1 ITA e 2 in M2 FRA. Possibilità di applicare sia su sedile che schienale un pannello tappezzato, oppure dotare la seduta di una fodera tappezzata amovibile. La serie si distingue per la varietà delle strutture atte a soddisfare le varie esigenze, quindi strutture fisse o girevoli ed anche su trave. Finitura delle strutture in colore nero (N), cromata (CR) o in colore grigio alluminio (VA).

Multifunctional series based on a seat made with Polypropylene single shell available in 14 colours (including the arm pads), 8 of which are available in a fireproof CL1 (ITA) and 2 of each in fireproof M2 (FRA). The seat can be embellished with a removable cover or with fixed upholstered panels. The series is offered with multiple frames suited to meet various community needs. It includes items with a 4-leg or sled base, with or without armrests, with or without hook, or beam or swivel bases. The frame finishing comes with black (N), chromed (CR) or aluminium grey (VA) finish.

Série multifonctions avec coque en Polypropylène en 14 couleurs, dont 8 sont disponibles en CL1 ITA et 2 en M2 FRA. Il est possible d'appliquer sur l'assise ainsi que sur le dossier un placet tapissé, ou de munir l'assise d'une housse. La série se distingue par la variété de ses structures, adaptées à toutes les exigences, structures fixes ou tournantes ainsi que sur poutre. Finition des structures de couleur noire (N), chromée (CR) ou gris aluminium (VA).

Mehrzweck-Objektstuhl mit Schale aus Polypropylen, in 14 Farben erhältlich, 8 davon auch in flammhemmender Ausführung (CL1 ITA und 2 in M2 FRA). Es besteht die Möglichkeit, sowohl am Sitz wie am Rücken eine Polsteraufdoppelung anzubringen oder die Schale mit einem abnehmbaren Polsterüberzug zu bestücken. Die Serie hebt sich besonders durch die Vielfalt an verfügbaren Gestellvarianten für die unterschiedlichsten Einsatzbereiche hervor: Stühle, Drehstühle oder Traversenbänke. Ausführungen: Schwarz (N) oder aluminiumgrau (VA) beschichtet sowie verchromt (CR).

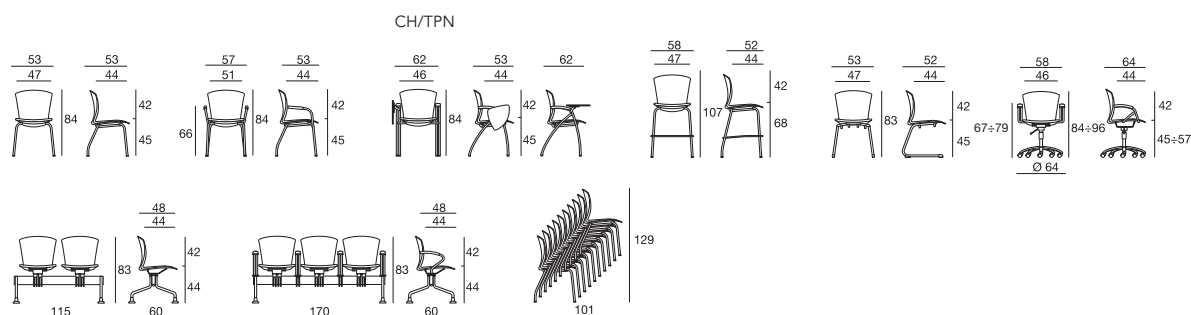

CARINA SKID design Studio Omega

p. 99

Carina Skid è proposta con o senza braccioli, nei 14 colori di Carina (poggiatesta inclusi), di cui 8 disponibili in CL1 ITA e 2 in M2 FRA. Possibilità di applicare sia su sedile che schienale un pannello tappezzato, oppure dotare la seduta di una fodera tappezzata amovibile. Per entrambi le versioni è disponibile uno scrittoio con aggancio rapido, sia destro che sinistro, denominato FAST. Le due versioni sono disponibili con piedini in colore neutro (scivoli per pavimenti duri), anche del tipo "agganciabile". La struttura di Carina Skid è realizzata in londino d'acciaio da Ø 11 mm, disponibile con finiture in colore nero (N), cromata (CR) o in bianco (BI).

Skid base version of Carina series, available with or without arms, based on the Polypropylene single shell available in 14 colours (including the arm pad), 8 of which are available in a fireproof CL1 (ITA) and 2 of each in fireproof M2 (FRA). The seat can be embellished with a removable cover or with fixed upholstered panels. For both frames, with or without arms, a FAST fitting writing tablet is available. Both frames are available with hard plastic glides in neutral colour for hard floors, also in version with hook for a fast ganging. The frame is made of Ø 11 mm steel rod duly bended and welded, with with black (N), chromed (CR) or white colour (BI) finishing.

Carina Skid est proposée avec ou sans accoudoirs, dans les 14 couleurs de Carina (compris les appui-bras), dont 8 disponibles en CL1 ITA et 2 en M2 FRA. Il est possible d'appliquer sur l'assise ainsi que sur le dossier un placet tapissé, ou de munir l'assise d'une housse. Pour les deux versions, est disponible une tablette écrivain à accrochage rapide, droite ou gauche, appelée FAST. Les deux versions sont disponibles avec patins de couleur neutre (patins glisseurs pour sols durs), aussi de type « accrochable ». La structure de Carina Skid est réalisée en tube d'acier de Ø 11 mm, disponible avec finition noire (N), chromée (CR) ou en blanc (BI).

Carina Skid wird mit oder ohne Armlehnen angeboten. In denselben 14 Farben wie CARINA (Armlehnen ebenso), 8 davon auch in flammhemmender Ausführung (CL1 ITA und 2 in M2 FRA). Es besteht die Möglichkeit, sowohl am Sitz wie am Rücken eine Polsteraufdoppelung anzubringen oder die Schale mit einem abnehmbaren Polsterüberzug zu bestücken. Beide Varianten können mit einem abnehmbaren Schreibbrett mit Schnellverschluss, Typ FAST, bestückt werden. Die farblosen Gestellgleiter (für harte Böden) sind auch in der Version als Reihenverbinder lieferbar. Das Gestell ist aus Rundstahl Ø 11 mm gefertigt und in den Ausführungen schwarz (N) oder weiß (BI) beschichtet sowie verchromt (CR) lieferbar.

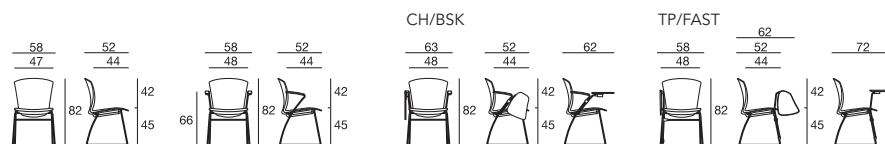

CARINA BASKET design Studio Omega & UT Sesta

p. 102

"Basket" è una nuova variante di Carina, progettata per spazi di formazione, per uffici dinamici e per spazi di co-working. La sedia è caratterizzata dalla seduta girevole (non elevabile) con grande scrittoio ruotabile a 360°, con portata di 68 Kg, dotata di basamento in Nylon con piano portaborse integrato. La base Ø 72 cm è in Nylon colore grigio (RAL 7040) e integra 6 ruote frenate/gommatae Ø 50 mm di colore grigio. Carina Basket è proposta con la finitura della struttura dello scrittoio in color grigio alluminio VA, mentre la monoscocca è disponibile nei 14 colori di Carina.

"Basket" is a new version of Carina designed for use in training spaces, dynamic offices and co-working spaces. The chair features a swivel seat (not height adjustable) with a large, 360° rotating writing tablet (capacity: 68 Kg), equipped with Nylon base with integrated basket. Ø 72 cm grey colour Nylon base (RAL 7040) that integrates 6 wheels braked / rubber Ø 50 mm gray color. The writing tablet frame of Carina Basket is available in aluminum gray colour VA, while the shell is available in 14 colours of Carina.

"Basket" est une nouvelle version de Carina, conçue pour les espaces de formation, pour bureaux dynamiques et espaces de cotravail. La chaise est caractérisée par son assise tournante (non réglable en hauteur) avec grande tablette écrivain tournant à 360°, d'une portée de 68 Kg, et équipée d'un piètement en Nylon avec tablette porte-sacs intégrée. Le piètement Ø 72 cm, en Nylon de couleur grise (RAL 7040), intègre 6 roulettes freinées/souples pour sols durs Ø 50 mm de couleur grise. Carina Basket est proposée avec finition de la structure de la tablette écrivain de couleur gris aluminium VA, alors que la monocoque est disponible dans les 14 couleurs de Carina.

"Basket" ist eine neue Variante aus der Serie Carina, für Schulungsbereiche, dynamische Büroarbeit und Coworking entwickelt. Die Hauptmerkmale sind die drehbare Sitzschale (nicht höhenverstellbar) mit großer Schreibplatte, die um 360° drehbar ist und eine Tragfähigkeit von 68 kg hat, und das Drehgestell aus Kunststoff (grau RAL 7040) mit integrierter Taschenablage. Das Drehgestell Ø 72 cm ist mit 6 gebremsten, weichen Doppelrollen Ø 50 mm ausgestattet. Der Tragrahmen der Schreibplatte ist aluminiumgrau (VA) beschichtet, während die Sitzschale in den 14 Farben von Carina verfügbar ist.

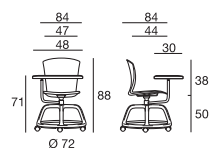

TA-CHERIE design Studio Omega

p. 104

Sedia con monoscocca in faggio multistrato, proposta in faggio naturale, sbiancato o wengé, con o senza pannelli tappezzati o completamente imbottita e rivestita. Struttura con o senza braccioli, con aggancio a scomparsa, proposta anche con scrittoio: disponibile anche su trave. Finitura verniciata nera (N), cromata (CR) o in colore grigio alluminio (VA).

Multifunction chair characterized by a multi-layered beechwood shell suggested both in natural beechwood (natural, bleached or wenge), with or without upholstered panels, or fully upholstered. Suggested with or without arms frame, both equipped with concealed connection hooks or with writing tablet. The seat is available also on beam. Frame finishing: painted in black (N) or grey aluminium colour (VA), or chrome (CR).

Chaise avec monoque en hêtre multiplis proposée en hêtre naturel, blanchi ou wengé, avec ou sans placets tapissés ou entièrement rembourrée et revêtue. Structure avec ou sans accoudoirs, avec accroche escamotable, proposée aussi avec tablette écriteire; disponible aussi sur poutre. Finition vernie noire (N), chromée (CR) ou de couleur gris aluminium (VA).

Objektstuhl mit einteiliger Schale aus Buchenschichtholz in den Ausführungen Buche Natur, weiß (Bleicheffekt) oder Wenge gebeizt, mit oder ohne Polsteraufdoppelungen oder komplett gepolstert. Gestell mit oder ohne Armlehnen, mit einklappbarem Reihenverbindungsbügel, auch mit Schreibbrett bestückbar, lieferbar auch als Traversenbank. Ausführungen: Schwarz (N) oder aluminiumgrau (VA) beschichtet sowie verchromt (CR).

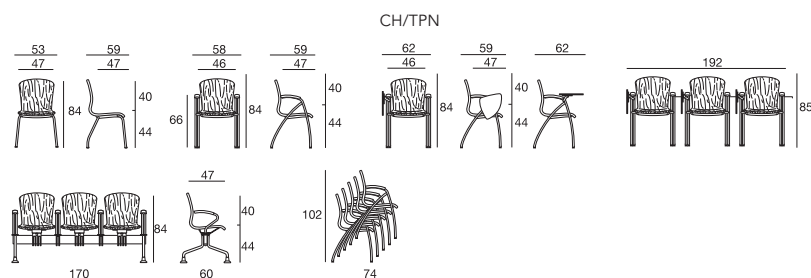

ADA 2 Act Design

p. 106

Poltrona per attesa, ospiti, conferenza. Imbottitura (realizzata da stampo) in Poliuretano flessibile, ignifugo in CL1, con inserto decorativo in acciaio posto sul retro in finitura nera (N) o cromata (CR). I braccioli e lo schienale formano un unico blocco imbottito, mentre il sedile è separato ed è fissato alla struttura con viti. L'imbottitura, che è completamente rivestita, ed è disponibile in ogni rivestimento a cartella. ADA 2 è disponibile con scrittoio antipanico posto a destra ed è attrezzabile con ganci fissi o ruotabili. Con l'optional A2-FX è possibile dotare lo schienale di flessibilità, a vantaggio del confort (+ 20°). Di serie piedini in alluminio lucidato (LU) oppure in PVC nero (N), o con ruote.

Ada 2 is a tub chair for visitors, meeting or conference rooms. The padding is made in fire retardant CL1 Polyurethane molded foam (from mold). The series stands out for the steel plate decoration at the rear of the backrest, available with a chromed or black finish. Arms and backrest form a unique bloc, while the seat is separated and fixed to backrest and sides by means of screws. Ada 2 is available with a right-hand anti-panic writing tablet, with fixed or rotational steel hook. The backrest can be further enhanced with the A2-FX optional, which, thanks to a system of springs placed in the insert, allows the backrest to flex and to tilt back by an additional 20° with a gradual and controlled "suspension". Polished aluminium glides (LU) or PVC black glides (N) or castors are available as standard.

Fauteuil pour attente, visiteurs, conférence. Rembourrage (réalisé par moulage) en Polyuréthane souple, ignifuge CL1, avec enjoliveur d'acier à l'arrière du dossier, disponible avec une finition noire (N) ou chromée (CR). Le dossier et les accoudoirs forment un bloc unique rembourré, tandis que l'assise, séparée, est fixée à la structure à l'aide de vis. Le revêtement, qui recouvre entièrement le bloc rembourré, est disponible dans tous les choix du nuancier. Ada 2 est disponible avec une tablette d'écriture anti-panique à droite, ou avec un crochet en acier fixe ou rotatif. Le dossier peut être encore amélioré avec l'option A2-FX, qui, grâce à un système de ressorts placés dans l'insert, permet au dossier de fléchir et de s'incliner de 20° supplémentaires avec une "suspension" graduelle et contrôlée. Proposé avec patins en aluminium poli (LU) ou en PVC noir (N), ou avec roulettes.

Sessel für den Warte- Besucher oder Konferenzbereich. Formschaumteil aus elastischem feuersicherem Polyurethan Kl. 1, mit Dekorelement aus Stahl an der Rückseite der Rückenlehne in den Ausführungen verchromt (CR) oder schwarz (N). Rückenlehne und Armlehnen bestehen aus einer einzigen Formschale, während die Sitzfläche eigenständig und mit Schrauben befestigt ist. Die Polsterteile sind komplett bezogen wobei aus dem gesamten Stoffsortiment gewählt werden kann. ADA2 kann mit einer Schreibplatte mit Anti-Panik-Funktion, rechts angebracht sowie mit starren oder drehbaren Reihenverbinder bestückt werden. Die Option A2-FX macht die Rückenlehne flexibel (+20°) und erhöht den Sitzkomfort. Der Sessel kann mit Gleitern aus glanzpoliertem Aluminium, Gleitern aus schwarzem PVC oder mit Rollen bestückt werden.

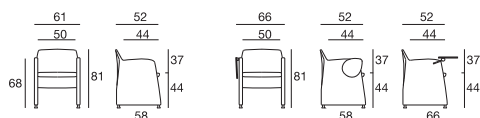

ADA 2 FOLD Act Design

p. 108

Poltrona derivata da Ada 2 ma in versione richiudibile, che consente di ridurre l'ingombro della stessa in profondità (26 cm). Le parti (schienale, fianchi, sedile) sono tutte realizzate da stampo in schiumato poliuretano ignifugo in CL1. Proposta anche con scrittoio e con possibilità di aggancio. È arricchita da decoro posteriore in acciaio nero (N) o cromato (CR). Proposta con piedini in alluminio lucidato oppure in PVC nero, o con ruote.

Ada 2 Fold is the foldable version of Ada 2 tub chair, ideal for non-permanent conference rooms. Its foldable sides and seat allow to reduce the depth of the armchair to 26 cm. Parts are made with moulded with CL1 class fire-retardant moulded foam. Ada2 Fold is also available with right-hand anti-panic writing tablet and can be ganged in a row. Ada 2 Fold, which is embellished with a black or chromed steel decoration at the rear, is available with glides (polished or PVC black aluminium) or with castors.

Fauteuil dérivé de Ada 2 mais en version pliante, ce qui permet de réduire son encombrement en profondeur (26 cm). Les différentes parties (dosier, côtés, assise) sont toutes réalisées en mousse de polyuréthane moulé par injection, ignifuge CL1. Proposé aussi avec tablette écriteiro et possibilité d'accrochage. Il s'enrichit d'une décoration à l'arrière du dossier en acier noir (N) ou chromé (CR). Proposé avec patins en aluminium poli ou en PVC noir, ou avec roulettes.

Dieser Sessel ist von ADA 2 abgeleitet und ist einklappbar. Dadurch lässt sich beim Lagern der Platzbedarf reduzieren (26 cm). Alle Elemente (Rücken, Seiten, Sitz) bestehen aus Formschaumteile aus elastischem feuersicherem Polyurethan der Klasse 1. Er kann mit Schreibplatte und Reihenverbindung bestückt werden und ist auf der Rückseite mit einem Dekorelement aus Stahl, verchromt (CR) oder schwarz (N) bestückt. Zur Auswahl stehen Gleitern aus Aluminium poliert, aus PVC schwarz oder Rollen.

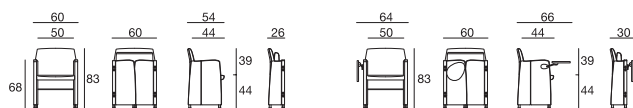

GO MEET design UT Sesta

p. 110

Il tavolo è proposto con profondità del piano di 60 cm (piede da 60 cm) e di 80 cm (piede da 70 cm), entrambi con larghezze: 80, 120, 140, 160, 180 cm e con profondità di 50 cm con larghezze da 140 e 180 cm. Gambe proposte con finitura nera (N), cromata (CR) o verniciata in colore grigio alluminio (VA); trave e supporti di rotazione sono in colore nero. Ruote gommatae Ø 65 mm con freno a pedale. Le due facce del piano sono in laminato HPL spessore 0,9 mm, con bordo in ABS da 27 mm (vedi finiture disponibili a pag. 228).

Nesting table, suggested with 60 cm (w/foot 60 cm) and 80 cm (w/foot 70 cm) wide top combined with five top-length: 80, 120, 140, 160 and 180 cm and with 50 cm wide-top combined with 140 and 180 cm top-length. Legs available in black colour (N), chrome (CR) or grey aluminium colour (VA) finishing. The beam and the rotational supports are in black colour. The top surfaces are made in HPL laminate 0,9 mm thick. The top edge is in ABS 27 mm high (see our finishing on page 228).

Cette table est proposée avec profondeur du plateau de 60 cm (pied de 60 cm) et de 80 cm (pied de 70 cm), tous les deux avec les largeurs suivantes: 80, 120, 140, 160, 180 cm et avec profondeur de 50 cm avec les largeurs de 140 et 180 cm. Pieds proposés avec finition noire (N), chromée (CR) de couleur gris aluminium (VA); la traverse et les supports de rotation sont de couleur noire. Roulettes souples pour sols durs Ø 65 mm avec frein à pédale. Les deux faces du plateau sont en stratifié HPL de 0,9 mm d'épaisseur, avec chant en ABS de 27 mm (voir finitions disponibles page 228).

Der Klappstisch ist ausschließlich mit Plattentiefe 70 cm oder 80 cm erhältlich (geringere oder größere Plattentiefen sind nicht möglich), während als Breite 120, 140, 160, und 180 cm lieferbar sind. Die Beinelemente können schwarz (N) oder weiß (BI) beschichtet oder verchromt (CR) sein, Traverse und Gelenke sind schwarz. Weiche Doppelrollen Ø 80 mm mit Feststellfunktion (Pedal). Die Platte ist beidseitig mit HPL beschichtet (Stärke 0,9 mm) und mit einer 27 mm-ABS-Kante versehen (Ausführungen siehe Seite 228).

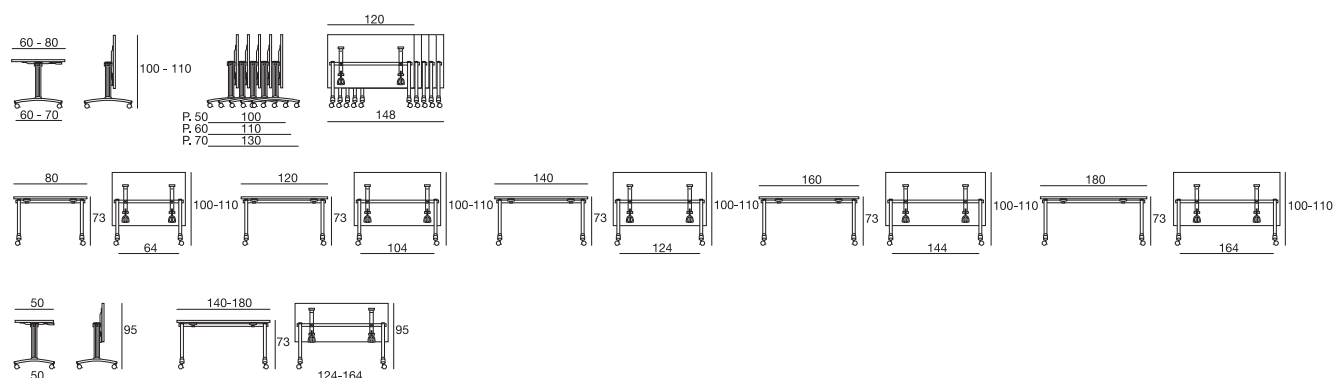

GO LITE design UT Sesta

p. 112

Il tavolo parcheggiabile è proposto solo profondità del piano di 70 cm o 80 cm (non è possibile una misura inferiore a 70 cm e superiore a 80 cm), mentre le larghezze sono: 120, 140, 160, 180 cm. Gambe proposte con finitura nera (N), cromata (CR) o bianca (BI); trave e supporti di rotazione sono in colore nero. Ruote gommatae Ø 80 mm con freno a pedale. Le due facce del piano sono in laminato HPL spessore 0,9 mm, con bordo in ABS da 27 mm (vedi finiture disponibili a pag. 228).

Nesting table suggested with top depth of 70 and 80 cm (is not possible a size less than 70 cm and over 80 cm). The standard widths are: 120, 140, 160, 180 cm. Leg finishing: black colour (N), chrome (CR) and white colour (BI). The beam and the rotational supports are in black colour. Ø 80 mm standard castors with brake lever. The top surfaces are made in HPL laminate 0,9 mm thick. The top edge is in ABS 27 mm high (see our finishing on page 228).

La table pliante est proposée avec profondeur du plateau de 70 cm ou de 80 cm (aucune dimension inférieure à 70 cm ou supérieure à 80 cm n'est possible), les différentes largeurs sont: 120, 140, 160, 180 cm. Pieds proposés avec finition noire (N), chromée (CR) ou blanche (BI); la traverse et les supports de rotation sont de couleur noire. Roulettes souples pour sols durs Ø 80 mm avec frein à pédale. Les deux faces du plateau sont en stratifié HPL de 0,9 mm d'épaisseur, avec chant en ABS de 27 mm (voir finitions disponibles page 228).

Der Tisch ist mit Plattentiefe 60 cm (Fuß 60 cm) und 80 cm (Fuß 70 cm) verfügbar, beide mit Breite: 80, 120, 140, 160, 180 cm, sowie mit Plattentiefe 50 cm und Breite 140 und 180 cm. Beinelemente können schwarz (N) oder aluminiumgrau (VA) beschichtet oder verchromt (CR) sein, Traverse und Gelenke sind schwarz. Weiche Doppelrollen Ø 65 mm mit Feststellfunktion (Pedal). Die Platte ist beidseitig mit HPL beschichtet (Stärke 0,9 mm) und mit einer 27 mm-ABS-Kante versehen. (Ausführungen siehe Seite 228).

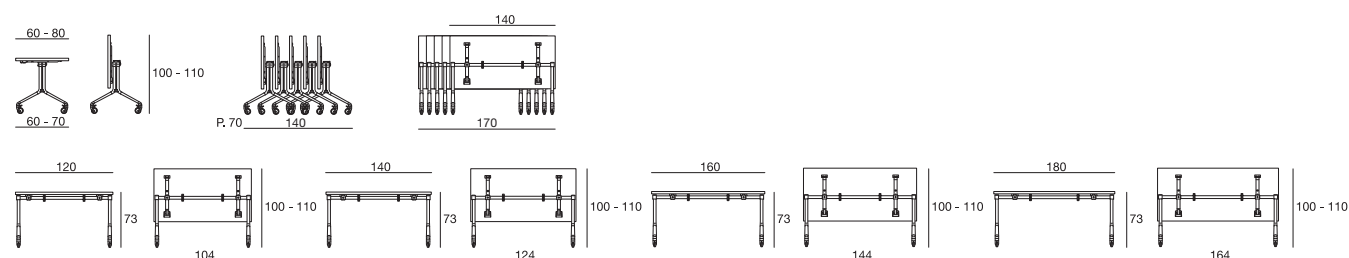

Q-44 BANCO design Studio Omega

p. 114

Banco studio per aula universitaria, sale di formazione, ecc., caratterizzato, per le sole file intermedie, dalla condivisione di un solo montante della seduta e del banco, mentre per prima e ultima fila, sia il banco che la panca, sono indipendenti. Il piano del banco è proposto sia in versione fissa che ribaltabile (per caduta). La seduta è disponibile in più varianti: "PP" sedile e schienale in Polipropilene in 6 colori, "IMPP" con sedile tappezzato e schienale in Polipropilene in 6 colori, "IM" completamente tappezzata, "W" con sedile e schienale in faggio naturale. La serie è corredata dal "pannello frontale di cortesia" e dalla "rete porta libri". Finiture: nero (N) e in colore grigio RAL 9007 (VA7).

Desk for lecture halls, training rooms etc.; in the middle rows only, the seat and desk share a single upright, whereas they are detached in the front and back rows. The desk top comes in both fixed and folding version (drop down). The seat is available in several versions: "PP" Polypropylene seat and backrest in 6 colours, "IMPP" upholstered seat and Polypropylene backrest in 6 colours, "IM" completely upholstered, "W" natural beech seat and backrest. The series also comes with "front courtesy panel" and "mesh book holder". Finishes: black (N) and RAL 9007 grey (VA7).

Banc d'étude pour amphithéâtre universitaire, salles de formation, etc., qui se caractérise, pour les seules rangées intermédiaires, par son unique montant pour le siège et la tablette du banc, alors que pour la première et la dernière rangée, ils sont indépendants. La tablette du banc peut être fixe ou rabattable (pliante vers le bas). Le siège est disponible en plusieurs versions: "PP" assise et dossier en Polypropylène 6 couleurs, "IMPP" avec assise tapissée et dossier en polypropylène 6 couleurs, "IM" entièrement tapissé, "W" avec assise et dossier en hêtre naturel. La série se complète d'un "voile de fond" et d'un "casier porte-revues". Finition: noire (N) ou grise RAL 9007 (VA7).

Schulbank für Hörsäle, Schulungsräume usw. Eine einzige Tragsäule stützt gleichzeitig Sitz und Tisch. Nur bei der ersten und letzten Reihe sind diese eigenständig. Die Schulbank ist sowohl mit fixer, wie auch mit klappbarer Tischplatte (abfallend) erhältlich. Der Sitz ist in verschiedenen Versionen lieferbar: "PP" Sitz und Rücken aus Polypropylen in 6 Farben, "IMPP" mit gepolstertem Sitz und Rücken aus Polypropylen in 6 Farben, "IM" komplett gepolstert, "W" mit Sitz- und Rückenschale aus Buchen-Schichtholz. Eine Frontblende und ein Ablagekorb runden das Programm ab. Ausführungen: beschichtet in schwarz (N) oder grau RAL 9007 (VA7).

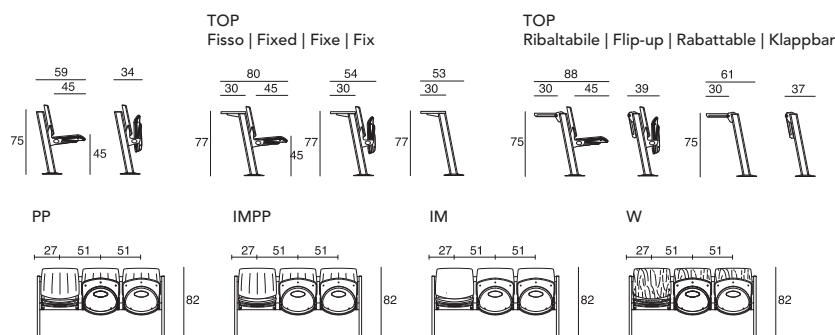

Q-44 TIP-UP design Studio Omega

p. 116

Seduta con sedile ribaltabile, posta su trave, ideale per aule didattiche, sale conferenza, ecc. La seduta è disponibile in più varianti: "PP" sedile e schienale in Polipropilene in 6 colori, "IMPP" con sedile tappezzato e schienale in Polipropilene in 6 colori, "IM" completamente tappezzata, "W" con sedile e schienale in faggio naturale. La serie è proposta con gambe dotate di piede per fissaggio a terra e di braccioli intermedi, con o senza scrittoio. Finitura disponibile in colore nero (N), e in colore grigio (VA7).

Beam-mounted bench with flip-up seat for conference, lecture rooms, etc. The seat is available in several versions: "PP" polypropylene seat and backrest in 6 colours, "IMPP" upholstered seat and Polypropylene backrest in 6 colours, "IM" completely upholstered, "W" natural beech seat and backrest. Q-44 Tip-Up is available with legs with floor-fixing foot, with or without writing tablet. Black colour (N), or grey colour (VA7) finishing.

Siège sur poutre avec assise rabattable, pour salles de cours, de conférence, etc. Le siège est disponible en plusieurs versions: "PP" assise et dossier en polypropylène 6 couleurs, "IMPP" avec assise tapissée et dossier en Polypropylène 6 couleurs, "IM" entièrement tapissé, "W" avec assise et dossier en hêtre naturel. La série est proposée avec pieds sur patins de fixation au sol et d'accoudoirs intermédiaires, avec ou sans tablette écrivain. Finition disponible en noir (N) et en gris (VA7).

Traversenbank mit Klappsitz, ideal für Hör-, Vortrags- Konferenzsäle usw. Der Sitz ist in verschiedenen Versionen lieferbar: "PP" Sitz und Rücken aus Polypropylen in 6 Farben, "IMPP" mit gepolstertem Sitz und Rücken aus Polypropylen in 6 Farben, "IM" komplett gepolstert, "W" mit Sitz- und Rückenschale aus Buchen-Schichtholz. Die Stützsäulen sind mit Fußplatten für die Bodenbefestigung versehen, es können Mittelarmlehnen eingesetzt werden, mit oder ohne Schreibplatte, Ausführungen: beschichtet in schwarz (N) oder grau (VA7).

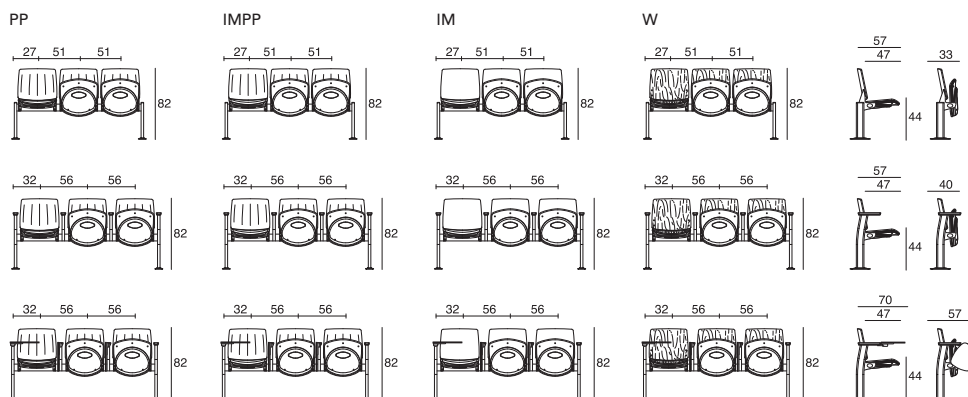

Q-44 CONFERENCE design Studio Omega

p. 118

Poltrona modulare per sala conferenza, Aula Magna. La serie, che si può adattare alle varie esigenze, con personalizzazioni, sia per quanto riguarda le dimensioni che la tipologia della seduta, è molto versatile e si integra alle serie Q-44 Banco, Q-44 Tip-Up e Q-44 Fix.

Modular chair for conference rooms, lecture theatres. This series can be customised to meet varying needs, both in terms of size and type of seat: it is very versatile and goes with the Q-44 Banco, Q-44 Tip-Up and Q-44 Fix series.

Fauteuil modulaire pour salle de conférence, amphithéâtre universitaire. La série peut s'adapter aux différents besoins en personnalisant les dimensions et les types de sièges car elle est très éclectique. Elle s'intègre bien aux séries Q-44 Banco, Q-44 Tip-Up et Q-44 Fix.

Modulare Objektsessel für die Bestuhlung von Konferenzsälen, Aula Magna usw. Diese Serie wird objektbezogen geplant und an die verschiedenen Ansprüche angepasst. Verschiedene Personalisierungsmöglichkeiten, sei es hinsichtlich Abmessungen, sei es hinsichtlich Sesseltyp sind möglich. Das Produkt ist besonders flexibel und vielseitig und fügt sich in die Großfamilie Q-44 Banco, Q-44 Tip-Up und Q-44 Fix ein.

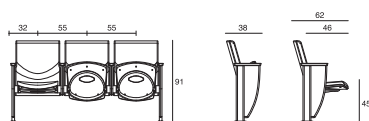

AUDITORIUM design UT Sesta

p. 120

Poltrona modulare per conferenza con fianco-bracciolo completamente tappezzato sino a terra. La seduta è molto confortevole grazie alla generosità delle dimensioni e alla corretta imbottitura. Dal disegno semplice e lineare, si integra perfettamente in ogni ambiente. Le dimensioni e la forma possono comunque variare in base a precise esigenze progettuali. Sono disponibili anche le versioni con scrittoio a scomparsa nel fianco, e anche con scrittoio ribaltabile applicato sul retro dello schienale.

Modular chair for conference with side-arm completely upholstered till the floor level. The seat comfort is very high thanks to the generous seat dimensions and to the correct softness of the foam. With a clean and linear design, the series can be installed in any kind of ambiente. The chair can be customized, in terms of shape and dimensions. The series can be equipped with a concealed writing tablet (which goes into the side arm) and also with a flip-up writing tablet placed on the rear of the backrest.

Fauteuil modulaire pour salle de conférence avec son élément côté-accoudoir entièrement tapissé jusqu'au sol. Le siège est très confortable grâce à ses dimensions généreuses et à son parfait rembourrage. Avec son dessin simple et linéaire, il s'intègre à la perfection partout. Ses dimensions et sa forme peuvent être toutefois modifiées selon les besoins du projet. On peut aussi disposer des versions avec tablette écrite, escamotable sur le côté ou rabattable lorsqu'elle est appliquée à l'arrière du dossier.

Modulares Sesselsystem für den Konferenzbereich mit Wangen-Armlehnen, vollständig gepolstert bis Bodenhöhe. Dank seiner Abmessungen und der guten Polsterung weist der Sessel einen hervorragenden Sitzkomfort auf. Das einfache und lineare Design fügt sich in jede Umgebung ein. Die Maße und Form können auf Wunsch an die speziellen Gegebenheiten eines Projektes angepasst werden. Ergänzend steht eine Version mit integrierter Schreibplatte, die unsichtbar in die Armlehne verschwindet und eine Klappbare Schreibplatte an der Rückenlehne zur Verfügung.

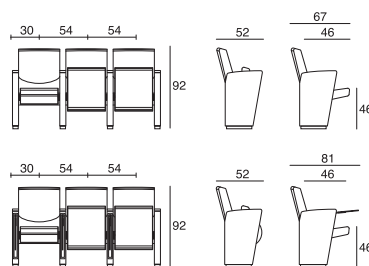

BLOG Design Alessio Pozzoli

p. 124

Famiglia composta da elementi d'arredo destinati a zone d'aggregazione, spazi collettivi, aree break zone attesa, musei. Nello spirito di Blog, gli elementi di arredo devono essere il più possibile adattabili per forma, dimensioni e funzionalità ad ogni ambiente. La famiglia è formata da sgabelli, pouf, poltrone, panche, divani, librerie fisse o mobili corredate da pannelli di separazione, parete mobile per la configurazione rapida di ambienti, lavagna su ruote o da agganciare ai pannelli o alla parete mobile, tavoli da lavoro, tavolini.

This family consists of furnishing elements designed for co-working areas, community spaces, break-out areas, waiting rooms and museums. In the spirit of Blog, the shape, size and performance of these elements must be as adaptable as possible to fit in with any surroundings. The family is formed of stools, footstools, armchairs, benches, sofas, mobile or standing bookcases equipped with separation panels, mobile partition for a fast configuration of ambiances, mobile boards, utility tables and coffee tables.

Famille composée d'éléments d'ameublement destinés aux zones agrégatives, telles que les espaces collectifs, les aires de repos, les salles d'attente, les musées. Dans l'esprit de Blog, les éléments d'ameublement doivent être le plus possible adaptables par forme, dimensions et fonctionnalité à tous les locaux. La famille comprend des tabourets, des poufs, des fauteuils, des banquettes, des canapés, des bibliothèques fixes ou sur roulettes aussi équipés avec des panneaux de séparation, des cloisons mobiles sur roulettes pour configurer rapidement les ambiances, un tableau sur roulettes, des tables de travail, des tables basses.

Die Produktfamilie besteht aus Einrichtungselementen für Begegnungsbereiche, Gemeinschaftsräume, Wartend Pausenbereiche sowie Museen. Im Geiste von Blog müssen sich die Einrichtungselemente so weit wie möglich in Form, Größe und Funktionalität an jede Umgebung anpassen lassen. Zur Programmfamilie gehören Hocker, Sessel, Bänke, Sofas, feststehende und mobile, mit Trennpaneelen ergänzbare Bücherregale, eine mobile Trennwand zur schnellen Raumkonfiguration, eine Tafel auf Rädern oder zum Anhängen an die Paneele und die mobile Trennwand sowie Arbeits- und Beistelltische.

Vedere catalogo specifico | See specific catalogue | Voir catalogue spécifique | Siehe spezifischen Katalog:

BLOG / STILE BERLINESE/2

SEZ. 1	SEZ. 2	SEZ. 3	SEZ. 4	SEZ. 5	SEZ. 6
SEDIE CHAIRS CHAISES STÜHLE	PANCHE/DIVANI BENCHES/SOFAS BANQUETTES/CANAPÉS BÄNKE/SOFAS	SGABELLI STOOLS TABOURETS HOCKER	TAVOLINI COFFEE TABLES TABLES BASSES BEISTELLTISCHE	TAVOLI TABLES TABLES TISCHE	LIBRERIE/PARETI/LAVAGNE BOOKCASES/PANELS/BOARDS BIBLIOTHÈQUES/CLOISONS/TABLEAUX BÜCHERREGALE/WÄNDE/TAFELN



BOTERO Act Design

p. 138

Serie composta da poltrona, poltrona girevole, divano a due posti, pouf e tavolino. Confort di seduta elevato, assicurato dai vari strati di gomma a densità differenziata che formano l'imbottito e dalle cinghie elastiche sul sedile. Struttura portante in parti assemblate di multistrato di conifera e abete spessore 18 mm. Rivestimento della struttura lignea con pannelli sagomati di fessite da 2,5 mm. Poltrona girevole con base piana d'acciaio da Ø 540 mm, spessore 8 mm; versione fissa invece dotata di piedini regolabili (15 mm). Poltrona e divano sono rivestiti con fodere distinte: una per il sedile ed una per lo schienale; pouf rivestito con un'unica fodera fissata sotto la base della seduta.

TAVOLI DI CORTESIA - I tavoli hanno il piano fisso o ruotabile a 360°, entrambi di forma ellittica 780x570 mm; top in MDF laccato opaco bianco (RAL 9010) o antracite (RAL 7005). Lo stesso può essere rivestito in pelle in abbinamento al divano (finta pelle e tessuto non disponibili). Struttura portante composta da colonna Ø 50 mm con base piana di forma ellittica 680x500 mm, spessore 8 mm. Finiture: struttura bianca (RAL 9010) o cromata con copertura in acciaio inossidabile.

Range composed of armchair, swivel armchair, two-seater sofa, low long stool and side table. High level of comfort assured by the different layers of variable density Polyurethane foam padding and by the elastic webbing on the seat. Framework in assembled parts of 18 mm thick fir and spruce plywood. Wooden frame clad in 2,5 mm thick, shaped hardboard panels. Swivel armchair comes with a Ø 540 mm, 8 mm thick flat steel base; the fixed version is fitted with adjustable levellers (15 mm). Armchair and sofa are upholstered with separate covers: one for the seat and one for the backrest; low long stool covered with a single fixed cover under the seat base.

COURTESY TABLES - the tables have a fixed top or 360° rotating top, both elliptical (780x570 mm); top in matte white (RAL 9010) or anthracite (RAL 7005) lacquered MDF. This can also be covered in leather to match the sofa (faux leather and fabric not available). Framework composed of Ø 50 mm column with flat, 8 mm thick elliptical shaped base (680x500 mm). Finishes: white (RAL 9010) or chrome finish with stainless steel cover.

Série composée d'un fauteuil, d'un fauteuil tournant, d'un canapé deux places, d'un pouf et d'une table basse. Grand confort de l'assise, assuré par les nombreuses couches de mousse à densités différenciées du rembourrage, et par les sangles élastiques tendues sur l'assise. Structure portante en parties assemblées de multiplis de conifère et sapin de 18 mm d'épaisseur. Revêtement de la structure en bois avec panneaux profilés d'isorel de 2,5 mm. Fauteuil tournant avec socle plat en acier Ø 540, épaisseur 8 mm; version fixe munie de patins réglables (mm 1,5). Le fauteuil et le canapé sont revêtus de housses différentes: une pour l'assise et une pour le dossier; pouf revêtu d'une seule housse fixée sous la base du siège.

TABLES DE SERVICE - les tables ont le plateau fixe ou tournant à 360°, tous les deux de forme elliptique 780x570 mm; plateau en MDF laqué mat blanc (RAL 9010) ou anthracite (RAL 7005). Celui-ci peut aussi être revêtu en cuir assorti au canapé (simili cuir et tissu non disponibles). Structure portante composée d'une colonne Ø 50 mm avec socle plat de forme elliptique 680x500, épaisseur 8 mm. Finitions: structure blanche (RAL 9010) ou chromée avec couverture en acier inoxydable.

Die Reihe besteht aus Sessel, Drehsessel, Zweisitzer-Sofa, Hocker und Beistelltische. Der hohe Komfort wird durch die Polsterung aus mehreren Schichten PU-Schaumstoff mit verschiedenen Dichten sowie die Sitzunterfederung mit Elastikgurten gewährleistet. Das tragende Gestell setzt sich aus mehreren 18 mm starken Kiefer- und Fichten-Schichtholzteilen zusammen. Das Gestell ist mit 2,5 mm starken geformten Pressholzplatten beplankt. Der Drehsessel hat einen 8 mm starken Stahlsteller Ø 540 mm, während die feststehende Ausführung verstellbare Gleiter (15 mm) besitzt. Sessel und Sofa haben zwei getrennte Bezüge, je einen für Sitz und Rückenlehne. Der beim Hocker unter der Sitzfläche befestigte Bezug ist dagegen einteilig.

BEISTELLTISCHE - Die Tische haben eine feste oder um 360° drehbare Platte, beide Ausführungen sind ellipsenförmig 780x570 mm und bestehen aus einer matt lackierten MDF-Platte in weiß (RAL 9010) oder anthrazit (RAL 7005). Sie ist auch passend zum Sofa bezogen lieferbar (Stoff und Kunstleder nicht erhältlich). Das tragende Gestell besteht aus einer Säule Ø 50 mm mit einem 8 mm starken, elliptischen Fußteller 680x500 mm. Ausführungen: Gestell weiß (RAL 9010) oder verchromt mit Edelstahl-Abdeckung.

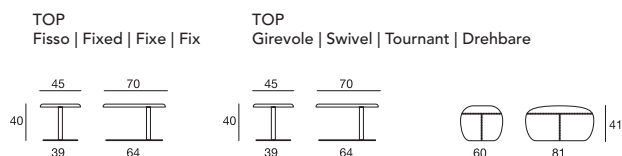
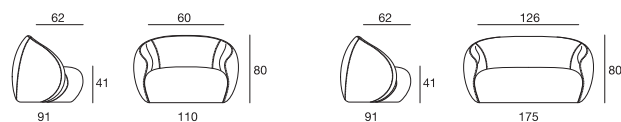

DAY&NIGHT Design Alessio Pozzoli

p. 142

Poltroncina per attesa, ospiti, riunioni. Seduta realizzata con monococca in Polietilene in 8 colori. La serie è proposta sia in versione girevole, sia in versione fissa. La versione girevole è proposta con base a 4 gambe in acciaio conifcato (definita a ragno) con finitura cromata (CR), nera (N) o verniciata grigio alluminio (VA); oppure con base a 4 razze Ø 70 cm dotate di piedini, o a 5 razze Ø 64 cm con ruote o piedini, entrambi con finitura lucida (LU). La versione fissa è proposta con struttura a 4 gambe in acciaio Ø 22 mm con piedini articolati oppure con struttura a 4 gambe in legno massello di faggio, finitura naturale, con piedini in plastica dura per moquette. Day&Night è corredata anche da un tavolino porta riviste avente il top in Polietilene negli 8 colori della socca e la base piana in acciaio Inox.

Small armchair for lounge areas, visitors, meeting rooms, break and community areas, featuring a Polyethylene single shell available in 8 colours. Day&Night comes with various types of bases, namely: swivel non-height adjustable with 4-leg base (spider) in black (N), chromed (CR) or grey aluminum (VA) finishing, or height adjustable swivel with polished (LU) aluminium Ø 64 five-star base, or in a fixed version with 4-leg base in metal, with chrome (CR) or black (N) or grey aluminum (VA) finishing, or in 4 solid wood legs, made of solid beechwood, natural finishing. The seat can be fitted with an upholstered panel fastened with screws at the time of manufacturing. Day&Night comes with its own magazine-holder table and has a stainless steel flat base and Polyethylene top available in the 8 colours of the shell.

Petit fauteuil pour attente, visiteurs, réunions. Siège réalisé avec une monocoque en Polyéthylène 8 couleurs. La série est proposée soit en version tournante, soit en version fixe. La version tournante est proposée avec piètement à 4 branches en tube d'acier conique (piètement araignée) avec finition chromée (CR), noire (N) ou de couleur gris aluminium (VA); ou avec piètement à 4 branches Ø 70 cm munies de patins, ou à 5 branches Ø 64 cm avec roulettes ou patins, tous les deux avec finition polie (LU). La version fixe est proposée avec structure à 4 pieds en acier Ø 22 mm avec patins articulés ou encore avec structure à 4 pieds en bois massif de hêtre, finition naturelle, avec patins en plastique dur pour moquette. Day&Night est livré avec sa propre petite table porte-revues et possède une base plate en acier inoxydable et un plateau en Polyéthylène disponible dans les 8 couleurs de la coque.

Sessel für den Warte-, Besucher- und Konferenzbereich. Einteiliger Schalensitz aus Polypropylen in 8 Farben, sowohl als Drehstuhl als auch als feststehender Stuhl angeboten. Die Drehstuhlvariante kann mit einem 4-Bein-Gestell aus konischem Stahl (Spider) verchromt (CR), schwarz (N) oder aluminiumgrau (VA) beschichtet, einem 4-Stern-Fußkreuz Ø 70 cm mit Gleitern oder einem 5-Stern-Fußkreuz Ø 64 cm mit Rollen oder Gleitern, beide glanzpoliert (LU) ausgestattet sein. Die feststehende Variante wird mit einem 4-Bein-Gestell aus Stahl Ø 22 mm mit Gelenkgleitern oder mit 4-Bein-Gestell aus Buchen-Massivholz Natur mit Kunststoffgleitern für Textilböden bestückt. Das Programm beinhaltet auch einen Beistelltisch mit Tischplatte aus Polyethylen in den 8 Farben der Schale und flacher Fußplatte aus Edelstahl.

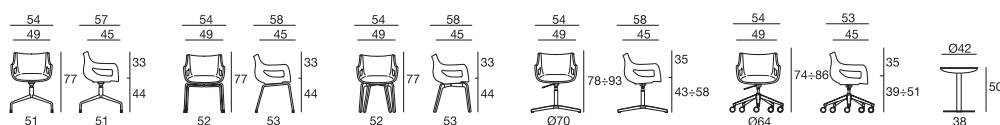

D&N PAD Design Alessio Pozzoli

p. 144

Poltroncina per attesa, ospiti, riunioni. D&N Pad è la versione completamente tappezzata di Day&Night, il suo interno rimane in Polietilene. Il sedile tappezzato di questa versione è fisso (fissato con viti). La serie è proposta sia in versione girevole e sia in versione fissa. La versione girevole è proposta con base a 4 gambe in acciaio conifcato (definita a ragno) con finitura cromata (CR), nera (N) o verniciata grigio alluminio (VA); oppure con base a 4 razze Ø 70 cm dotate di piedini o a 5 razze Ø 64 cm con ruote o piedini, entrambi con finitura lucida (LU). La versione fissa è proposta con struttura a 4 gambe in acciaio Ø 22 mm con piedini articolati oppure con struttura a 4 gambe in legno massello di faggio, finitura naturale, con piedini in plastica dura per moquette.

Armchair for waiting areas, visitors, meetings. Fully upholstered version of Day&Night Polyethylene shell. The upholstered seat is fitted to the shell with screws. D&N Pad comes with various types of bases, namely: swivel non-height adjustable with 4-leg base (spider) in black (N), chromed (CR) or grey aluminum (VA) finishing, or height adjustable swivel with polished (LU) aluminium Ø 64 cm five-star base, or in a fixed version with 4-leg base in metal, with chrome (CR) or black (N) or grey aluminum (VA) finishing, or in 4 solid wood legs, made of solid beechwood, natural finishing.

Petit fauteuil pour attente, visiteurs, réunions. D&N Pad est la version entièrement tapissée de Day&Night. L'intérieur reste en Polyéthylène. Le siège tapissé de cette version est fixe (fixé avec vis). La série est proposée soit en version tournante, soit en version fixe. La version tournante est proposée avec piètement à 4 branches en tube conique d'acier (piètement araignée) avec finition chromée (CR), noire (N) ou de couleur gris aluminium (VA); ou avec piètement à 4 branches Ø 70 cm munies de patins, ou à 5 branches Ø 64 cm avec roulettes ou patins, tous les deux avec finition polie (LU). La version fixe est proposée avec structure à 4 pieds en acier Ø 22 mm avec patins articulés ou encore avec structure à 4 pieds en bois massif de hêtre, finition naturelle, avec patins en plastique dur pour moquette.

Sessel für den Warte-, Besucher- und Konferenzbereich. D&N Pad ist die vollständig bezogene Variante von Day&Night. Die Innenschale bleibt unverändert aus Polypropylen. Das gepolsterte Sitzkissen ist fest mit der Schale verschraubt. Sowohl als Drehstuhl als auch als feststehender Stuhl erhältlich. Die Drehstuhlvariante kann mit einem 4-Bein-Gestell aus konischem Stahl (Spider) verchromt (CR), schwarz (N) oder aluminiumgrau (VA) beschichtet, einem 4-Stern-Fußkreuz Ø 70 cm mit Gleitern oder einem 5-Stern-Fußkreuz Ø 64 cm mit Rollen oder Gleitern, beide glanzpoliert (LU) ausgestattet sein. Die feststehende Variante wird mit einem 4-Bein-Gestell aus Stahl Ø 22 mm mit Gelenkgleitern oder mit 4-Bein-Gestell aus Buchen-Massivholz Natur mit Kunststoffgleitern für Textilböden bestückt.

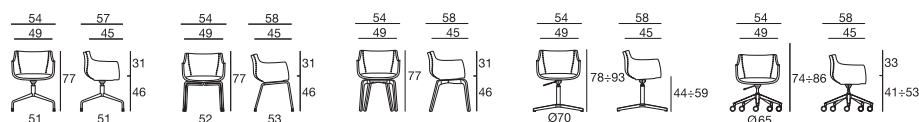

D&N PLUS design Alessio Pozzoli

p. 146

Poltroncina per attesa, ospiti, riunioni. D&N Plus si differenzia da D&N Pad per la presenza del cuscino amovibile fissato alla seduta con Velcro. La serie è proposta sia in versione girevole e sia in versione fissa. La versione girevole è proposta con base a 4 gambe in acciaio conifcato (definita a ragno) con finitura cromata (CR), nera (N) o verniciata grigio alluminio (VA); oppure con base a 4 razze Ø 70 cm dotate di piedini o a 5 razze Ø 64 cm con ruote o piedini, entrambi con finitura lucida (LU). La versione fissa è proposta con struttura a 4 gambe in acciaio Ø 22 mm con piedini articolati oppure con struttura a 4 gambe in legno massello di faggio, finitura naturale, con piedini in plastica dura per moquette.

Armchair for waiting areas, visitors, meetings. Alternative version of D&N Pad shell. The difference between the Pad version and the Plus version consist in the seat pad, which is, in this last, removable and changeable. D&N Plus comes with various types of bases, namely: swivel non-height adjustable with 4-leg base (spider) in black (N), chromed (CR) or grey aluminum (VA) finishing, or height adjustable swivel with polished (LU) aluminium Ø 64 cm five-star base, or in a fixed version with 4-leg base in metal, with chrome (CR) or black (N) or grey aluminum (VA) finishing, or in 4 solid wood legs, made of solid beechwood, natural finishing.

Petit fauteuil pour attente, visiteurs, réunions. D&N Plus se différencie de D&N Pad par la présence d'un coussin mobile fixé au siège par du velcro. La série est proposée soit en version tournante, soit en version fixe. La version tournante est proposée avec piètement à 4 branches en tube conique d'acier (piètement araignée) avec finition chromée (CR), noire (N) ou de couleur gris aluminium (VA); ou avec piètement à 4 branches Ø 70 cm munies de patins, ou à 5 branches Ø 64 cm avec roulettes ou patins, tous les deux avec finition polie (LU). La version fixe est proposée avec structure à 4 pieds en acier Ø 22 mm avec patins articulés ou encore avec structure à 4 pieds en bois massif de hêtre, finition naturelle, avec patins en plastique dur pour moquette.

Sessel für den Warte-, Besucher- und Konferenzbereich. D&N Plus unterscheidet sich von D&N am abnehmbaren Sitzkissen der am Sitz angeheftet ist. Sowohl als Drehstuhl als auch als feststehender Stuhl erhältlich. Die Drehstuhlvariante kann mit einem 4-Bein Gestell aus konischem Stahl (Spider) verchromt (CR), schwarz (N) oder aluminiumgrau (VA) beschichtet, einem 4-Stern-Fußkreuz Ø 70 cm mit Gleitern oder einem 5-Stern-Fußkreuz Ø 64 cm mit Rollen oder Gleitern, beide glanzpoliert (LU) ausgestattet sein. Die feststehende Variante wird mit einem 4-Bein-Gestell aus Stahl Ø 22 mm mit Gelenkgleitern oder mit 4-Bein-Gestell aus Buchen-Massivholz Natur mit Kunststoffgleitern für Textilböden bestückt.

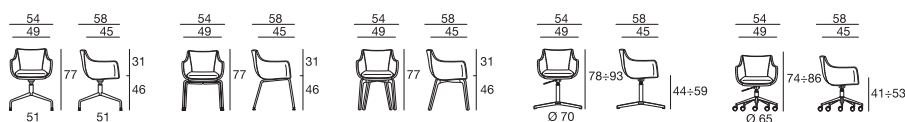

SMILE design Studio Omega

p. 148

Poltrona per attesa, area break, ospiti, realizzata in un unico stampo in Poliuretano flessibile ignifugo in Classe 1 con inserto portante in acciaio. È proposta in 4 versioni: fissa con struttura in acciaio a 4 gambe dotata di piedini articolati; girevole (non elevabile) con base piana in acciaio Inox di forma quadrata 45x45 cm con lati ragglati; girevole ed elevabile con base in alluminio con finitura lucida Ø 70 cm a 4 razze dotata di piedini per pavimenti duri; con base in alluminio con finitura lucida Ø 70 cm a 5 razze con ruote Ø 65 mm frenate/gommate per pavimenti duri.

Armchair for lounge and break areas, visitors, made with class CL1 fire-retardant flexible moulded Polyurethane with steel insert. It is available in three types of bases: a 4-leg cone-shaped steel tube fitted with articulated glides with either a black (N), chromed (CR) or aluminium grey (VA) finish; a non-height adjustable swivel version with a flat stainless steel base; a height adjustable swivel version with a polished aluminium (LU), aluminium grey (VA) or Nylon 5-star base. They are all available with castors or glides.

Fauteuil pour attente, salle de repos, visiteurs, réalisé en Polyuréthane souple injecté en moule, non feu Classe 1 avec ossature en acier. Il est proposé en 4 versions: fixe avec structure en acier à 4 pieds munis de patins articulés; tournant (non réglable en hauteur) avec socle plat en acier Inox de forme carrée 45 x 45 cm aux angles arrondis; tournant et réglable en hauteur avec piètement en aluminium en finition polie Ø 70 cm à 4 branches munies de patins pour sols durs; avec piètement en aluminium en finition polie Ø 70 cm à 5 branches avec roulettes Ø 65 mm freinées et souples pour sols durs.

Sessel für Warte-, Pausen- und Besucherbereich aus einem einteiligen Formschaumteil aus elastischem, feuersicherem Polyurethan (K11) mit integriertem Tragrahmen aus Stahl. Es stehen 4 Gestellvarianten zur Auswahl: Feststehend mit 4-Bein-Gestell aus Stahl mit Gelenkgleitern, drehbar (nicht höhenverstellbar) mit flacher rechteckiger Fußplatte aus Edelstahl 45 x 45 cm mit abgerundeten Ecken, drehbar und höhenverstellbar mit 4-Stern-Fußkreuz Ø 70 cm aus Aluminium glanzpoliert mit Gleitern für harte Böden oder mit 5-Stern-Fußkreuz Ø 70 cm aus Aluminium glanzpoliert mit gebremsten weichen Rollen Ø 65 mm für harte Böden.

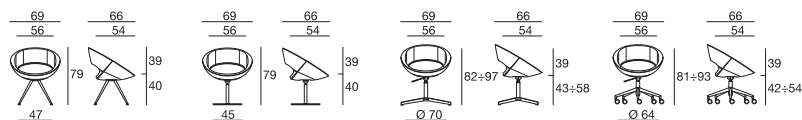

BIG design Studio Omega

p. 150

Poltrona per attesa, ospiti, avente base a slitta con braccioli integrati. Poggiabraccia PBP in Polipropilene colore nero. Sedile imbottito e rivestito con fodera amovibile nei rivestimenti a cartella. Schienale in Metacrilato trasparente spessore 10 mm.

Armchair for visitors and lounge with cantilever base with arms. Standard PBP arm caps are available in black Polypropylene. The seat comes with a thick and comfortable padding with removable cover. Backrest made in transparent Metacrylate 10 mm thick.

Fauteuil pour attente et visiteurs avec piètement luge et accoudoirs intégrés. Manchettes PBP en Polypropylène de couleur noire. Assise rembourrée avec revêtement déhoussable de notre nuancier. Dossier en Méthacrylate transparent de 10 mm d'épaisseur.

Sessel für den Warte- und Besucherbereich mit Freischwingergestell und integrierten Armlehnen. Armauflagen PBP aus Polypropylen schwarz. Gepolsterte Sitzfläche mit abnehmbarem Bezug, nach Wahl aus dem Gesamtsortiment. Rückenlehne aus farblosem Acryl, 10 mm stark.

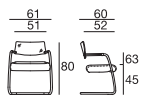
**FREE** design UT Sesta

p. 152

Serie composta da sedia, poltrona e sgabello, tutte disponibili con base fissa a slitta realizzata in tondino d'acciaio Ø 12 mm. Le tre sedute sono proposte anche in versione girevole: la sedia con base 4 razze Ø 70 cm in alluminio finitura lucida (LU); la poltrona con base in acciaio a 4 razze Ø 80 cm con finitura solo cromata; lo sgabello con base piana Inox Ø 47 cm. Le finiture delle basi, a parte la base Inox (solo cromata), in colore nero (N), bianco (BI) e finitura cromata (CR).

Series comprising chair, lounge chair and stool, all available with fixed cantilever base made from Ø 12 mm tubular steel. The three seats also come in the swivel version: the chair with 4-star base Ø 70 cm, polished aluminium base (LU); the lounge chair with 4-star, Ø 80 cm steel base, chrome finish only; the stool with flat, Ø 47 cm stainless steel base. Except for the stainless steel base (chrome finish only), the base finishes are black (N), white (BI), and chrome (CR).

Série composée d'une chaise, d'un fauteuil et d'un tabouret, tous disponibles avec piètement luge en tube rond d'acier Ø 12 mm. Les trois sièges sont aussi proposés en version tournante: la chaise avec piètement à 4 branches Ø 70 cm en aluminium poli (LU); le fauteuil avec piètement à 4 branches Ø 80 cm, uniquement en finition chromée; le tabouret avec socle plat en Inox Ø 47 cm. Les finitions des piètements, à part le socle Inox (uniquement chromé), sont dans les couleurs noir (N), blanc (BI) et finition chromée (CR).

Produktfamilie bestehend aus Stuhl, Sessel und Hocker, alle mit Freischwingergestell aus Rundstahl Ø 12 mm. Zudem sind sie auch mit Drehgestell erhältlich: Drehstuhl mit 4-Stern-Fußkreuz Ø 70 cm aus Aluminium, glanzpoliert (LU), Drehsessel mit 4-Stern-Fußkreuz Ø 80 cm aus Stahl, Drehhocker mit flacher Fußplatte aus Edelstahl Ø 47 cm. Mit Ausnahme der Fußplatten aus Edelstahl, die nur verchromt angeboten werden können die Gestelle verchromt (CR) sowie schwarz (N) oder weiß (BI) beschichtet sein.

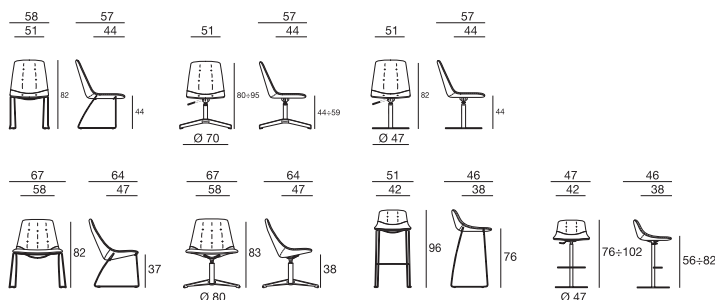

LOLA design UT Sesta

p. 154

Poltroncina per ospiti, attesa, riunioni. Proposta anche in versione sgabello con dimensioni più ridotte. La seduta è realizzata da due elementi separati, il sedile e lo schienale, uniti tra di loro in maniera permanente. La struttura interna è in faggio multistrato, mentre l'imbottitura è in gomma poliuretana tagliata da blocco, con spessori e densità differenziate. La serie è proposta in 4 versioni: fissa con struttura in acciaio a 4 gambe dotata di piedini articolati; girevole (non elevabile) con base piana in acciaio Inox di forma tonda Ø 47 cm; girevole ed elevabile con base in alluminio con finitura lucida Ø 70 cm a 4 razze dotata di piedini per pavimenti duri; con base in alluminio con finitura lucida Ø 64 cm a 5 razze con ruote Ø 65 mm frenate/gommate per pavimenti duri. Lo sgabello girevole è dotato di base tonda Ø 47 cm in acciaio Inox, con poggiatesta di forma ovale in acciaio cromato.

Chair for visitor's, waiting, meeting. Also available in stool version with smaller dimensions. The chair is made in one piece composed by two elements, seat and backrest. The inner frame is made in beechwood, padded with Polyurethane cut foam in different densities. The series is available in 4 versions: fixed with 4-leg structure with articulated glides; swivel (not height adjustable) with flat stainless steel base Ø 47 cm; swivel and height adjustable with 4-star Ø 70 cm polished aluminum base with glides for hard floors; with 5-star Ø 64 cm base in polished aluminum with Ø 65 mm braked/rubber castors for hard floors. The swivel stool is equipped with a round Ø 47 cm stainless steel base, with oval footrest in chromed steel.

Petit fauteuil pour visiteurs, attente, réunions. Proposé aussi en version tabouret avec des dimensions plus réduites. Le corps du siège se compose de deux éléments séparés, l'assise et le dossier, qui sont fixés entre eux de façon permanente. L'insert est en hêtre multiplis et le rembourrage est en mousse de Polyuréthane découpée, avec épaisseurs et densités différentes. La série est proposée en 4 versions: fixe avec structure à 4 pieds munis de patins articulés; tournante (non réglable en hauteur) avec socle plat en acier Inox de forme ronde Ø 47 cm; tournante et réglable en hauteur avec piétement en aluminium poli Ø 70 cm à 4 branches munies de patins pour sols durs; avec piétement en aluminium poli Ø 64 cm à 5 branches munies de roulettes Ø 65 mm freinées/souples pour sols durs. Le tabouret tournant est équipé d'un socle rond Ø 47 cm en acier Inox, avec repose-pieds de forme ovale en acier chromé.

Sessel für den Warte-, Besucher-, und Konferenzbereich. Auch als Hocker mit kleineren Abmessungen verfügbar. Die Sitzeinheit besteht aus zwei getrennten Elementen: Sitzfläche und Rückenlehne, die dauerhaft miteinander verbunden sind. Die Grundschaale ist aus Buchenschichtholz gefertigt, der Polsteraufbau besteht aus PU-Blockschaum mit verschiedenen Dichten und Stärken. Es stehen 4 verschiedene Gestellvarianten zur Auswahl: feststehend mit 4-Bein-Gestell aus Stahl mit Gelenkgleiter, drehbar (nicht höhenverstellbar) mit runder Fußplatte aus Edelstahl Ø 47 cm, drehbar und höhenverstellbar mit 4-Stern-Fußkreuz aus Aluminium glanzpoliert Ø 70 cm mit Gleiter für harte Böden und mit 5-Stern-Fußkreuz aus Aluminium glanzpoliert Ø 64 cm mit Gleiter für harte Böden und mit 5-Stern-Fußkreuz aus Aluminium glanzpoliert Ø 64 cm mit weichen/gebremsten Rollen Ø 65 mm für harte Böden. Der Drehhocker ist mit einer runden Fußplatte aus Edelstahl Ø 47 cm und einer ovalförmigen Fußstütze aus verchromten Stahl ausgestattet.

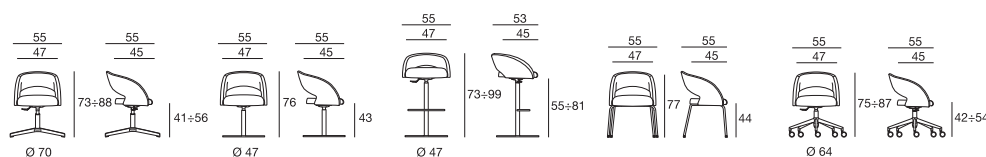

PAUL&FRANK design Favaretto&Partners

p. 156

Poltroncina, divanetto, e tavolini per zone d'attesa o aree break, proposti in due versioni: PAUL e FRANK. Frank si caratterizza dallo "chassis" metallico "a vista", quindi con l'imbottitura "in appoggio" (completamente amovibile, fissata con Velcro), mentre Paul ha la seduta completamente tappezzata. Sia Frank che Paul, hanno la fodera amovibile dotata di zip. Frank inoltre è proposta con la variante "DUFFLE", con la tappezzeria arricchita da bottoni trasparenti tipo Montgomery. Le finiture della struttura sono per entrambi: nero (N), grigio (VA), bianco (BI), melone (ME), cromato (CR).

Lounge chair, sofa and coffee tables for waiting areas or break areas, suggested in two versions PAUL and FRANK. Frank features an exposed sub-frame so the padding "rests on top" (fixed in place with Velcro, fully removable), while the padding on Paul is integrated in the padded sub-frame. Both Frank and Paul have removable zip-covers and the parts can be easily disassembled. Additionally Frank is suggested with an upholstery variant called "DUFFLE" since is enriched with transparent buttons, Montgomery style. Metal frames finishing are: black (N), aluminium grey (VA), white (BI), melon (ME), chrome (CR).

Petit fauteuil, canapé et tables basses pour salles d'attente ou de repos, proposés en deux versions: PAUL et FRANK. Frank se caractérise par son "châssis" métallique "visible", sur lequel est posé un coussin "d'appui" (donc mobile, fixé avec du Velcro). Paul, par contre, est un siège entièrement tapissé. Tous les deux ont une housse avec fermeture éclair qui peut être enlevée. Frank est aussi proposé en version "DUFFLE", avec une tapisserie enrichie de boutons transparents style Montgomery. Les finitions de leur structure sont: noir (N), gris (VA), blanc (BI), melon (ME), chromé (CR).

Sessel, Sofas und Beistelltische für Warte-, oder Loungebereich in zwei Versionen: PAUL und FRANK. Frank zeichnet sich durch den sichtbaren Tragrahmen aus Metall aus. Das aufgesetzte Polsterteil ist mit Klettverschlüssen befestigt und jederzeit abnehmbar. Paul hat hingegen einen komplett gepolsterten Sitz. Sowohl Frank, wie Paul haben einen abnehmbaren, mit Reißverschluss befestigten Überzug. Frank ist zudem in der Variante mit "DUFFLE", einer Aufwertung der Polsterung mit Balken und transparenten Knöpfen, Typ Montgomery verfügbar. Gestellausführungen für beide Varianten: schwarz (N), grau (VA), weiß (BI), Melone (ME), verchromt (CR).

PAUL

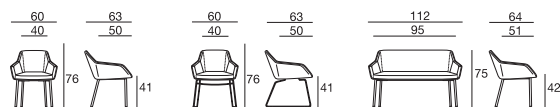

FRANK

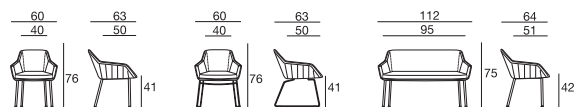

MODE SMALL design Studio Omega

p. 158

Serie per ospiti, riunioni, attesa, abbinata dalla serie Mode, di cui riprende lo stile con dimensioni ridotte.

Tappezzeria Plain oppure con variante Strip (con cuciture orizzontali su tutto il fronte della seduta). La serie è proposta in più versioni: girevole ed elevabile con base a 5 razze Ø 64 cm con finitura lucida; girevole con base Ø 70 cm a 4 razze alluminio con finitura lucida; con base piana in acciaio Inox di forma tonda Ø 47 cm in abbinamento al sistema di ritorno automatico della seduta (TORNA); fissa con struttura in tondino in acciaio Ø 11 mm con o senza braccioli (SKID). Versione su panca con piede autoportante in alluminio pressofuso, finitura lucida, dotato di piedini regolabili. Tutte le versioni sono disponibili con o senza braccioli.

Series for visitors, meetings and lounge areas, matching the Mode series from which is derived with a smaller size.

Mode Small is available with Plain (without front stitchings) and Strip (with front horizontal stitchings) upholstery. The padded series is available in one size only and with a height-adjustable swivel version (with a 5-star aluminium base) or a swivel version only (4-star aluminium base with glides and stainless steel round flat version). It is also available with a "skid" base made with Ø 11 mm steel rod, with or without armrests. Mode Small is also available in the beam version, with a multiple seat with or without armrests. The item has an oval-shaped aluminium beam and die-cast polished aluminium legs.

Siège pour visiteurs, réunions, attente, conçu, avec des dimensions réduites, selon le design de la série Mode.

Tapiserie Plain ou Strip (avec coutures horizontales sur le devant du siège). La série est proposée en plusieurs versions: tournante et réglable en hauteur avec piètement à 5 branches Ø 64 cm avec finition polie; tournante avec piètement Ø 70 cm à 4 branches en aluminium poli; avec socle plat en acier Inox de forme ronde Ø 47 cm équipé d'un système automatique de retour du siège (TORNA); fixe avec structure en tube d'acier Ø 11 mm, avec ou sans accoudoirs (SKID). Version sur poutre avec pied autoportant en aluminium moulé sous pression, finition polie, muni de patins réglables. Toutes les versions sont disponibles avec ou sans accoudoirs.

Produktsérie für den Warte-, Besucher- und Konferenzbereich. Von der Serie Mode abgeleitet, von der sie den Stil übernimmt, aber mit kleineren Abmessungen, in den Polsterungsvarianten PLAIN oder STRIP (horizontale Steppnähte auf der Frontseite). Es stehen verschiedene Gestellvarianten zur Auswahl: Drehbar und höhenverstellbar mit 5-Stern-Fußkreuz aus Aluminium Ø 64 cm glanzpoliert (LU), drehbar mit 4-Stern-Fußkreuz aus Aluminium Ø 70 cm glanzpoliert (LU), drehbar mit runder Fußplatte aus Edelstahl Ø 47 cm mit Rückholmechanik TORNA, feststehend mit Gestell aus Rundstahl Ø 11 mm, mit oder ohne Armlehnen (SKID), als Traversenbank mit selbsttragenden Gestellseiten aus Alu-Druckguss glanzpoliert mit einstellbaren Gleiter. Alle Varianten sind mit oder ohne Armlehnen verfügbar.

PLAIN

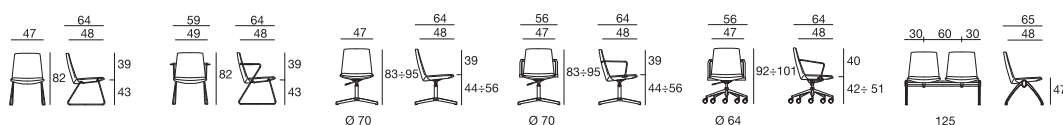

STRIP

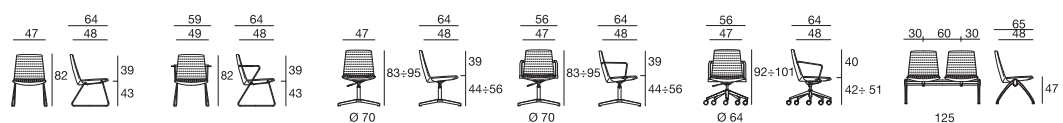

MODE TC design Studio Omega

p. 160

Serie per ospiti, riunioni, attesa, può essere abbinata alla serie Mode. La serie è proposta in due varianti: Mode TC e Mode TC XL (versione "up-grade" con schienale più alto di 4 cm). Come per la serie Mode, la monoscocca è disponibile con la tappezzeria in versione Plain oppure Strip. La serie è proposta solo con base a slitta, con braccioli integrati. I poggiatesta possono essere sia in Polipropilene colore nero oppure tappezzati. Finitura della struttura solo cromata (CR). La serie Mode TC si abbina perfettamente alla serie direzionale Mode.

Series for visitors, meetings and lounge areas available with Plain (without strips) and Strip (with horizontal strips) upholstery. The series is suggested with two dimensions of shells, that's to say: a standard height and a XL height (4 cm higher). The two shells are suggested with same cantilever base with armrests, featuring either black or upholstered Polypropylene arm caps. The frame is made with an Ø 25 mm Asform tube with chromed (CR) finish only. Mode TC can be matched with the executive series Mode.

Série pour visiteurs, réunions, attente, dans le style de la série Mode. Il existe deux versions: Mode TC et Mode TC XL (version "up-grade" avec dossier augmenté de 4 cm en hauteur). Comme pour la série Mode, la monocoque peut être tapissée avec Plain ou Strip. La série n'est proposée qu'avec piètement luge, avec accoudoirs intégrés. Les manchettes sont soit en Polypropylène noir, soit tapissées. Finition uniquement chromée (CR). Le Mode TC peut être associé au série exécutif Mode.

Serie für den Warte-, Besucher- und Konferenzbereich, als Erweiterung der Serie Mode, verfügbar in den Varianten: Mode TC und Mode TC XL (Die Rückenlehne ist um 4 cm höher). Mode TC ist ebenso wie Mode in den Polsterungsvarianten Plain oder Strip erhältlich. Mit Freischwingergestell und integrierten Armlehnen wobei die Armauflagen aus Polypropylen, Farbe schwarz oder gepolstert und bezogen sein kann. Das Gestell aus Stahlrohr ist verchromt (CR). Die Serie Mode TC kann bestens mit dem Direktionsessel Mode integriert werden.

TC PLAIN

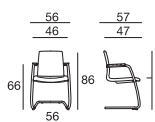

TC XL PLAIN

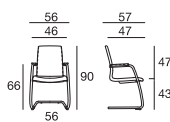

TC STRIP

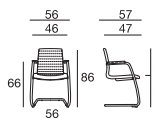

TC XL STRIP

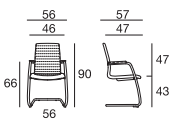

MODÌ design Studio Omega

p. 162

Poltroncina completamente tappezzata, per attesa, ospiti, riunioni. Caratteristica della serie è l'imbottitura in Poliuretano ignifugo flessibile, che è realizzata da un unico stampo avente la parte strutturale portante in acciaio: il cuscino del sedile, sempre realizzato in Poliuretano ignifugo flessibile, è un elemento indipendente che viene fissato permanentemente al sedile. La serie è proposta in versione fissa, a 4 gambe in acciaio conifcato con piedini articolati è disponibile cromata (CR) o in colore grigio alluminio (VA). Oppure in versione girevole. Versioni girevoli: base a 4 razze Ø 70 cm in alluminio finitura lucida con seduta elevabile; base Inox di forma tonda Ø 47 cm, non elevabile, abbinata al sistema di ritorno automatico della seduta (TORNA); base a 5 razze Ø 64 cm con finitura lucida, con seduta elevabile, con ruote o piedini.

Fully upholstered armchair for visitors, meeting and lounge areas, available in one size only. The main characteristic is that the padding is made in one piece, from a mold, with inner steel frame. The seat - which is separated from the frame and attached permanently with a series of screws - is fitted with a softer and more elastic padding compared to the rest of the armchair. The chair is suggested in a fixed version with a 4-leg base with conified legs equipped with articulated glides, available in chrome (CR) or grey aluminum colour (VA). Swivel version: height adjustable seat combined with a Ø 70 cm cross polished aluminium base with glides, or with a Ø 64 cm 5-star polished aluminium base with castors or a not height adjustable swivel version suggested with TORNA mechanism (self return of the seat) combined with a Ø 47 cm stainless steel round flat base.

Petit fauteuil entièrement tapissé, pour attente, visiteurs, réunions. Il se caractérise par sa structure en polyuréthane souple ignifuge moulée en une seule pièce sur un élément portant en acier; le coussin de l'assise, lui-même réalisé en polyuréthane souple ignifuge, est un élément indépendant qui est fixé de façon permanente à l'assise. La série est proposée en version fixe à 4 pieds en tube d'acier conique, avec patins articulés, uniquement chromée (CR) ou en couleur gris aluminium (VA), ou en version tournante. Versions tournantes: piètement à 4 branches Ø 70 cm en aluminium poli, réglable en hauteur; socle Inox de forme ronde Ø 47 cm, non réglable en hauteur, équipé d'un système de retour automatique du siège (TORNA); piètement à 5 branches Ø 64 cm avec finition polie, réglable en hauteur, avec roulettes ou patins.

Schalensessel, komplett gepolstert, für den Warte-, Besucher- oder Konferenzbereich. Charakteristisch für die Serie ist das einteilige Formschaumteil aus elastischem, feuersicherem PU-Schaum mit integrierter tragender Stahlkonstruktion. Das Sitzkissen aus feuersicherem elastischem PU-Schaum ist eigenständig und dauerhaft mit der Sitzfläche verbunden. Varianten: Feststehender Stuhl mit 4-Beinestell aus konischem Stahl (Spider) verchromt (CR) oder aluminiumgrau (VA) mit Gelenkgleitern, Drehstuhl höhenverstellbar mit 4-Stern-Fußkreuz Ø 70 cm aus Aluminium glanzpoliert, drehbar (nicht höhenverstellbar) mit runder Fußplatte Ø 47 cm aus Edelstahl mit Rückholmechanik (TORNA), Drehstuhl höhenverstellbar mit 5-Stern-Fußkreuz Ø 64 cm aus Aluminium glanzpoliert mit Rollen oder Gleiter.

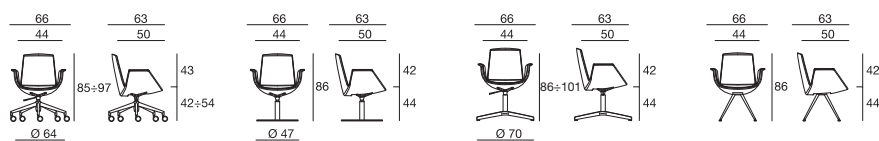

MODÀ LOUNGE design Studio Omega

p. 164

La serie Modà Lounge si caratterizza per l'accurata tappezzeria capitonné, posta su tutto il fronte della seduta. La serie è proposta con o senza poggiatesta. La poltrona è disponibile solo girevole, dotata di meccanismo basculante permanente (non bloccabile), ed è proposta con base a 4 razze in acciaio Ø 80 cm con finitura cromata, dotata di scivoli in plastica dura per pavimenti duri.

Modà Lounge series features detailed button tufted upholstery all over the seat front. The series comes with or without headrest. The lounge chair comes in swivel version only, fitted with continuous (not lockable) tilting mechanism: it has a Ø 80 cm cross base made from chromed steel and is fitted with hard plastic glides for hard floors.

La série Modà Lounge se caractérise par sa belle tapisserie capitonnée, qui recouvre tout le devant du siège. La série est proposée avec ou sans tête-tière. Le fauteuil est en version tournante, avec un mécanisme basculant permanent (non blocable), avec un piètement à 4 branches en acier Ø 80 cm finition chromée, munies de patins glisseurs en plastique dur pour sols durs.

Charakteristisch für die Serie Modà Lounge ist die Punktsteppung der Polsterung (capitonné) auf der Frontseite der Sesselschale. Mit oder ohne Kopfstütze erhältlich. Ausschließlich als Drehstuhl mit permanenter Wippmechanik (nicht feststellbar) mit 4-Stern-Fußkreuz Ø 80 cm aus Stahl, verchromt, Gleiter aus Kunststoff, geeignet für harte Böden.

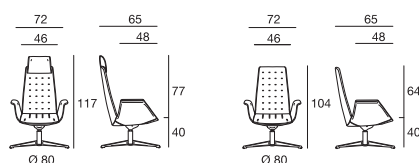

DAMA LOUNGE design Favaretto&Partners

p. 166

Derivata dall'imbottito della poltrona Dama, la poltrona Dama Lounge si differenzia per avere un'inclinazione della seduta prettamente d'attesa, quindi più inclinata rispetto a Dama Executive. La serie è proposta con due tipi di tappezzeria, Plain o Strip, e in due dimensioni: con poggiatesta e alta. La serie è proposta con un solo tipo di struttura fissa a 4 gambe. Finitura delle strutture in colore nero (N), cromata (CR) e bianca (BI). Alcuni accessori, posizionabili solo all'origine, arricchiscono la proposta: lo scrittoio (solo destro), che è ruotabile sul proprio asse a 180° e si posiziona sulla parte anteriore destra della struttura, e la presa USB-AUX, che si applica nello stesso punto dello scrittoio, anche in presenza dello scrittoio.

Dama Lounge series is a variant of Dama Executive series. Dama Lounge differs since has been conceived with a different frame inclination, in order to be more suitable for lounge areas. The upholstery is suggested in two ways, Plain (without front stitches) or Strip (with front stitches). The chair is suggested in two sizes: with headrest and with high backrest. The 4-leg metal frame is equipped with glides and is suggested in black (N) or chrome (CR) or white (BI) finishing. The lounge chair is enriched with a writing tablet (180° rotation) and separately or together with the tablet, a USB-AUX socket.

Dérivant du fauteuil Dama, Dama Lounge se différencie par l'inclinaison de son siège plus marquée pour l'attente. Il est donc plus incliné que le fauteuil Dama Executive. La série propose deux types de tapisserie, Plain ou Strip, et deux dimensions: avec tête et dossier haut. Elle ne prévoit qu'un seul type de structure fixe à 4 pieds, avec finition noire (N), chromée (CR) ou blanche (BI). Quelques accessoires, à positionner à l'origine, enrichissent cette offre: la tablette écriteiro (unique-ment de droite), pivotante à 180°, qui s'applique sur la partie antérieure droite de la structure, et la prise USB-AUX, qui s'applique au même endroit, même en présence de la tablette.

Vom Direktionsessel Dama abgeleitet, zeichnet sich Dama Lounge durch die Sitzneigung aus, die besonders auf den Wartebereich abgestimmt und im Vergleich zu Dama Executive stärker geneigt ist. Die Serie wird mit zwei Polsterversionen: Plain oder Strip und in zwei Größen, mit hoher Rückenlehne mit oder ohne integrierte Kopfstütze erhältlich. Beide mit 4-Bein-Gestell welches verchromt (CR) oder schwarz (N) oder weiß (BI) beschichtet sein kann. Nützliche Zubehörelemente, die nur im Produktionsprozess eingeplant werden können bereichern das Angebot: Schreibbrett (nur rechts), welches auf die eigene Achse um 180° drehbar ist und frontseitig auf der rechten Seite positioniert wird, USB-AUX-Anschlüsse an der gleichen Stelle wie das Schreibbrett im Gestellrohr integriert.

PLAIN

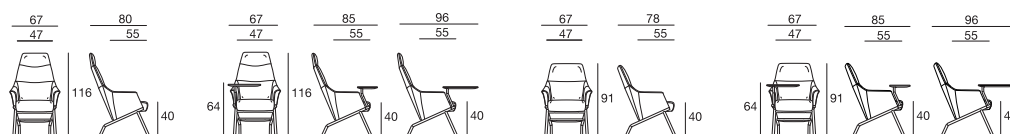

STRIP

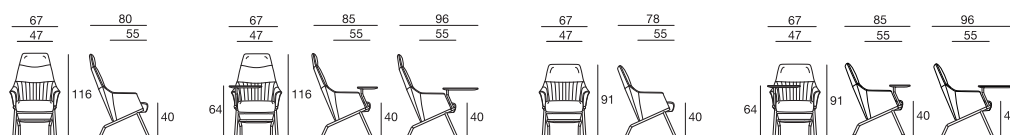

ADA 3 Act Design

p. 168

Poltroncina per attesa, ospiti, riunioni, appartenente alla vasta famiglia Ada di cui mantiene il design e le finiture. I braccioli, lo schienale e il sedile formano un unico imbottito realizzato da stampo in Poliuretano flessibile ignifugo. Sul retro dello schienale è posto un decoro in acciaio, con finitura cromata (CR) o nera (N).

La serie è proposta in 3 versioni: versione fissa con base a 4 gambe in acciaio con piedini articolati oppure a 4 gambe dotate di ruote per pavimenti duri (non frenate); in versione girevole (non elevabile), con base a 4 gambe in acciaio conficcato (definita a ragno) con finitura cromata (CR) o nera (N); con base piana in acciaio Inox di forma quadrata 45x45 cm con lati raggiati, finitura solo cromata (CR).

Armchair for waiting areas, visitors, meetings. Ada 3 is part of the wide Ada range, keeping its design and finishing. The padding is a single piece of fire retardant Polyurethane foam molded together with a steel insert: armrests, backrest and seat form a one-block chair. At the rear of the backrest there is a decoration, either a black (N) or chromed (CR) item, to match the finish of the frame.

The series is suggested in three versions: a fixed version with a four-leg frame with glides or castors (not braked, for hard floors), swivel version with a 4-leg base (spider base) with glides, a swivel version with a 45x45 cm stainless steel flat base only in chrome finishing.

Petit fauteuil pour attente, visiteurs, réunions, qui appartient à la grande famille Ada et dont il maintient le design et les finitions. Les accoudoirs, le dossier et l'assise forment une unique structure rembourrée, moulée en Polyuréthane souple ignifuge. A l'arrière du dossier, se trouve une décoration en acier, avec finition chromée (CR) ou noire (N).

La série est proposée en 3 versions: version fixe à 4 pieds en acier avec patins articulés ou à 4 pieds munis de roulettes pour sols durs (non freinées); version tournante (non réglable en hauteur), avec piètement à 4 pieds en tube conique d'acier (appelé araignée) avec finition chromée (CR) ou noire (N); avec socle en acier Inox de forme carrée 45x45 cm aux angles arrondis, finition unique chromée (CR).

Sessel für den Warte-Besucher und Konferenzbereich aus der Familie ADA von der er Design und Ausführungen übernimmt. Rückenlehne, Armlehnen und Sitzfläche bestehen aus einem einzigen Formschaumteil aus elastischem, feuersicherem PU-Schaum. Auf der Rückseite der Rückenlehne ist ein Dekorelement in den Ausführungen verchromt (CR) oder schwarz (N) angebracht.

Es stehen 3 Gestellvarianten zur Auswahl: Feststehender Sessel mit 4-Bein-Gestell aus Stahl mit Gelenkgleiter oder mit Rollen für harte Böden (nicht gebremst), Drehsessel (nicht höhenverstellbar) mit 4-Bein-Gestell (Spider) aus konischem Stahl verchromt (CR) oder schwarz (N), oder mit rechteckiger Fußplatte 45x45 cm aus Edelstahl mit abgerundeten Ecken, verchromt (CR).

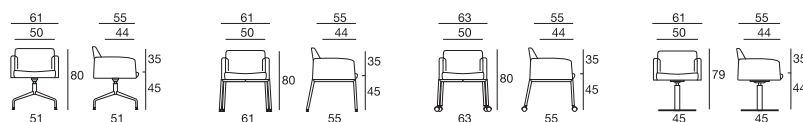

ADA 4 Act Design

p. 170

Divano a due posti e poltrona singola appartenente alla vasta famiglia Ada di cui mantiene il design e le finiture. La serie è proposta con struttura a 4 gambe in acciaio con finitura cromata (CR) o verniciata grigio alluminio (VA). La poltrona è disponibile anche in versione girevole, non elevabile, con base a 4 razze in acciaio Ø 80 cm, finitura cromata, dotata di scivoli in plastica dura per pavimenti duri. L'imbottito è in Poliuretano flessibile ignifugo ed è realizzato da stampo in un unico blocco. L'imbottito del sedile è un elemento autonomo, che può essere rimosso per manutenzione oppure essere sostituito. È disponibile la variante "Plus", con la tappezzeria arricchita. A completamento della serie sono proposti in abbinamento i tavolini bassi (vedi Tavolini).

Series consisting of a two-seated sofa and an armchair, matching the Ada range common design. The series is suggested with a 4-leg frame in chrome finishing (CR) or in grey aluminium finishing (VA). The armchair is available also in a swivel version, not height adjustable, equipped with a Ø 80 cm steel base chrome finishing with glides for hard floors. The padding consists of the moulded monoblock element, which includes the backrest, the armrests and the seat, while the seat cushion is made with fire-retardant block-cut foam. The seat comes with a removable cover, which is secured to the seat with a zip and Velcro, the series is suggested with standard upholstery or with an enreached upholstery called "Plus". The series is combined with low table tops (see Tavolini series).

Canapé deux places et fauteuil appartenant à la grande famille Ada, dont ils maintiennent le design et les finitions. La série est proposée avec structure à 4 pieds en acier finition chromée (CR) ou de couleur gris aluminium (VA). Le fauteuil est aussi proposé en version tournante, non réglable en hauteur, avec piètement à 4 branches en acier Ø 80 cm, finition chromée, munies de patins glisseurs en plastique dur pour sols durs. Le rembourrage, en Polyuréthane souple ignifuge, est moulé en un seul bloc. Le coussin de l'assise est un élément autonome, qui peut être enlevé ou remplacé au besoin. Il est disponible dans la version "Plus", avec tapisserie enrichie. Pour compléter la série, on propose les tables basses assorties (voir Tables basses).

Zweisitzersofa und Einzelsessel aus der Familie Ada von der sie Design und Ausführungen übernehmen. Die Serie ist mit 4-Bein-Gestell aus Stahl, verchromt (CR) oder aluminiumgrau (VA) beschichtet ausgestattet. Der Einzelsessel ist auch als Drehsessel mit fixer Höhe und 4-Stern-Fußkreuz aus Stahl Ø 80 cm, verchromt, mit Kunststoffgleiter für harte Böden erhältlich. Das Polsterteil besteht aus feuerbeständigem elastischem PUSchaum und ist als einteiliger Formschaumteil gefertigt. Der Sitzpolster ist eigenständig und kann jederzeit abgenommen oder ersetzt werden. Die Variante "PLUS", beinhaltet eine Aufdoppelung der Polsterung. Als Ergänzung der Serie stehen niedrige Teetische zur Verfügung (Siehe Tavolini).

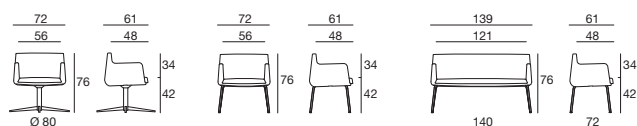

PLUS

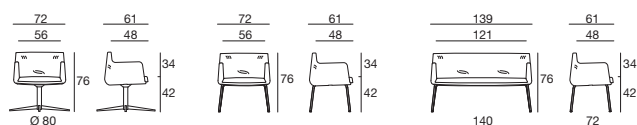

BRERA design UT Sesta

p. 172

Divano dal disegno classico ed elegante composto da: 1, 2, 3 posti e pouf. La serie offre un confort elevato, grazie alle cinghie elastiche poste sul sedile, alla corretta portanza dei cuscini del sedile e ai morbidi cuscini dello schienale (entrambi amovibili). Dotato di quattro piedini in acciaio da 25x25 mm finitura cromata, con scivoli in plastica adatto a ogni tipo di pavimento. A completamento della serie sono proposti in abbinamento i tavolini bassi con piano in laminato (vedi Tavolini).

Sofa with classic design suggested with 1, 2, or 3 seats and Pouf. Comfort is granted thanks to elastic straps on the seat and soft independent seat and back cushions, which have also removable covers. Equipped with 25x25 steel chrome legs with plastic glides suitable for all floors. The series is combined with coffee tables having the same legs. (See Tavolini).

Canapé au dessin classique et élégant proposé à 1, 2, 3 places plus pouf. Très confortable, grâce aux sangles élastiques tendues sur l'assise, à la bonne capacité de soutien des coussins de l'assise et au moelleux des coussins du dossier (tous les deux mobiles). Equipé de quatre petits pieds 25x25 mm en acier finition chromée, avec embouts en plastique adaptés à tout type de sol. Pour compléter la série, on propose les tables basses assorties, avec plateau en stratifié (voir tables basses).

Sofa mit klassischem und elegantem Design, als 1-, 2- oder 3-Sitzer sowie Hocker erhältlich. Die Serie zeichnet sich durch einen außerordentlichen Sitzkomfort aus, der durch elastische Tragegurte in der Sitzfläche, der angemessenen Kompaktheit der Sitzkissen und der weichen Rückenkissen (beide abnehmbar) gegeben ist. Die Möbelbeine aus Stahlprofil 25x25 mm, verchromt, sind mit Kunststoffgleitern versehen und für jegliche Böden geeignet. Als Ergänzung der Serie stehen niedrige Teetische mit Laminateplatte zur Verfügung (Siehe Tavolini).



ANDREW design UT Sesta

p. 174

Programma modulare per attesa composto da "Panca", "Panca con schienale", "Divano" e da "Box privacy" (con pannelli in feltro H 150 cm). I cuscini dello schienale sono di 2 tipi: rigido oppure soffice. I cuscini detti "rigidi" (sono comunque morbidi) e quelli "soffici" hanno ciascuno 2 dimensioni (90 e 120 cm il rigido e 60 e 90 il morbido) per gestire i 3 divani a piacere. La serie è proposta con struttura a slitta realizzata in tubolare d'acciaio Ø 18 mm con finitura solo cromata (CR) oppure con 4 piedini a sezione quadra 25x25 mm con finitura in colore grigio (VA).

Modular seating program for waiting areas. The series are based on "bench", "bench with backrest", "couch" and "Privacy box" (the H 142 cm side walls are covered with felt). Two kind of backrest cushions are available: one with a rigid shape (but they are soft) in two sizes (90 and 120 cm) while the other one is soft, like a pillow (60 and 90 cm) in order to be adapted for the 3 couch sizes. The serie is proposed with cantilever frame made in Ø 18 mm steel tube with chrome finishing (CR), or with square section feet 25x25 mm in aluminum grey finish (VA).

Programme modulaire pour salle d'attente, composé des éléments suivants: "Banc", "Banc avec dossier", "canapé" et "Box privé" (avec panneaux de feutre H 150 cm). Les coussins du dossier sont de 2 types: rigide ou souple. Les coussins dits "rigides" (en réalité ils sont souples) et les "souples" sont prévus chacun dans deux dimensions (90 et 120 cm le rigide, 60 et 90 cm le souple) pour organiser les 3 canapés à votre loisir. La série est proposée avec piètement luge en tube d'acier Ø 18 mm avec finition uniquement chromée (CR) ou avec 4 petits pieds à section carrée 25x25 mm avec finition de couleur grise (VA).

Modulares Möbelsystem für den Wartebereich bestehend aus "Bank", "Bank mit Rückenlehne", "Sofa" und "Box privacy" (mit Filzpaneelen H 150 cm). Die Rückenkissen sind als Kompaktpolster oder weiche Kissen erhältlich. Um die 3 Sofas beliebig ausstatten zu können sind sowohl die sog. Kompaktpolster (die weich sind) wie die weichen Kissen jeweils in zwei Breiten lieferbar: Kompaktpolster mit 90 und 120 cm und weiche Kissen mit 60 und 90 cm. Standardmäßig sind die Möbel dieser Serie mit einem Kufengestell aus Stahlrohr Ø 18 mm, verchromt (CR) ausgestattet. Alternativ stehen Möbelbeine aus Stahlprofil 25x25 mm, aluminiumgrau (VA) beschichtet zur Verfügung.

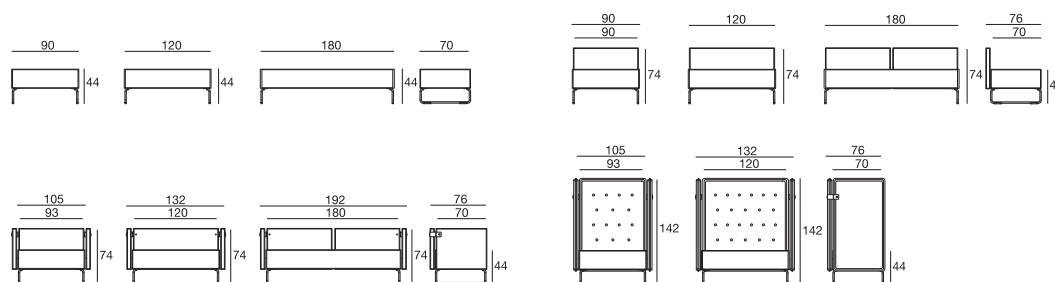

MODULO design Studio Omega

p. 176

Programma modulare per attesa composto da più elementi aggregabili tra loro: seduta, seduta a 45°, panca, panca a 45°, tavolini in laminato o in vetro anche a 90°, gambe laterali e gambe centrali. Modulo è anche disponibile con elementi indipendenti. La serie è proposta con struttura a slitta realizzata in tondino pieno d'acciaio Ø 14 mm con finitura cromata (CR), nera (N) o grigia (VA).

Modular seat program for lounge, composed of various elements: seat, rayed seat at 45°, terminal and intermediate leg, the straight or 45° bench, the table top, either straight or at 90° corner (available with both laminate or tempered glass). The serie is proposed with cantilever frame made in Ø 14 mm solid steel rod with chrome (CR), black (N) or grey (VA) finish.

Programme modulaire pour salle d'attente composé de plusieurs éléments à assembler entre eux: siège, siège 45°, banc, banc à 45°, tablettes en stratifié ou en verre, aussi à 90°, pieds d'extrémités et pieds intermédiaires. Modulo est aussi disponible avec éléments indépendants. La série est proposée avec piètement luge en rond plein acier Ø 14 mm avec finition chromée (CR), noire (N) ou grise (VA).

Modulares Möbelsystem für den Wartebereich bestehend aus verschiedenen untereinander verkettbaren Elementen: Sessel, 45°-Sessel, Beistelltische mit Laminat oder Glasplatte (auch als 90°-Element), Seitengestelle und Zwischengestelle. Modulo sind auch als eigenständige Elemente erhältlich. Das Kufengestell ist aus Rundstahl Ø 14 mm gefertigt und in den Ausführungen verchromt (CR), schwarz (N) oder grau (VA) verfügbar.

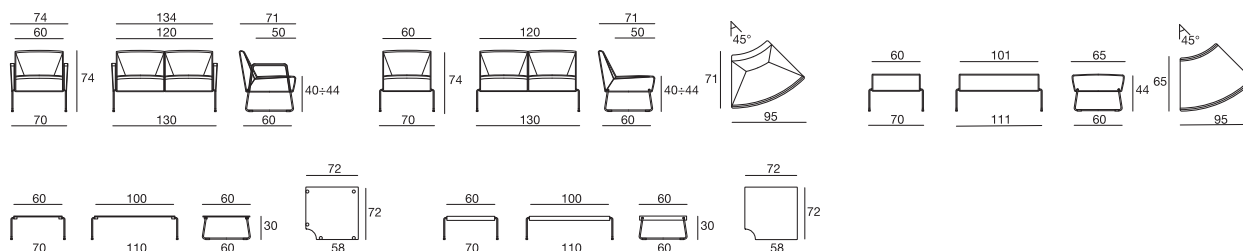

LINATE design Studio Omega

p. 178

Seduta modulare su trave destinata in ambienti ad alta affluenza di pubblico quali aeroporti, stazioni ferroviarie, ospedali, ecc. La seduta, con sedile e schienale indipendenti, è proposta in due varianti: "W" realizzata in faggio multistrato, proposta di serie con finitura naturale (F), sbiancata (FB) o wengè (WE); "IM" completamente tappezzata in tutti i rivestimenti a cartella. Disponibile con o senza braccioli. Le gambe autoportanti e i braccioli sono realizzati in alluminio con finitura lucida (LU), mentre la trave portante è in acciaio sezione 80x40 mm, finitura colore grigio (VA).

Modular seating on beam suggested for crowded ambiances like airports, train stations, hospitals, etc. The seat has independent seat and backrest suggested in two versions: "W" made of multi-layered beechwood with natural finishing (F) or bleached (FB) or wengè (WE); "IM" fully upholstered available in all coverings in our card. Available with or without arms. Self standing legs and arms, are made in die cast aluminium, polished finishing (LU), while the beam is in steel 80x40 mm section, grey aluminum colour (VA).

Siège modulaire sur poutre pour espaces à haute affluence de public tels que les aéroports, les gares, les hôpitaux, etc. Le siège, avec assise et dossier indépendants, est proposé en deux versions: "W" réalisé en hêtre multiplis, avec finition standard naturelle (F), blanchie (FB) ou wengè (WE); "IM" entièrement tapissé dans tous les revêtements de notre nuancier. Disponible avec ou sans accoudoirs. Les pieds autoportants et les accoudoirs sont réalisés en aluminium poli (LU), la poutre portante à section 80x40 mm est en acier, finition grise (VA).

Modulare Traversenbank für Bereiche mit hohem Publikumsaufkommen, wie z.B.: Flughäfen, Bahnhöfe, Krankenhäuser usw. Die eigenständigen Sitz- und Rückenschalen sind in zwei Ausführungen lieferbar: "W", aus Buchen-Schichtholz gefertigt, serienmäßig in den Ausführungen Buche Natur (F), weiß (Bleicheffekt) (FB) oder Wenge (WE) und "IM" vollständig gepolstert und bezogen aus dem komplettem Bezugstoffsortiment. Beide sind mit oder ohne Armlehnen lieferbar. Die selbsttragenden Gestellbeine und die Armlehnen bestehen aus Aluminium glanzpoliert (LU), die tragende Traverse hingegen aus Stahlprofil 80x40 mm, grau beschichtet (VA).

W

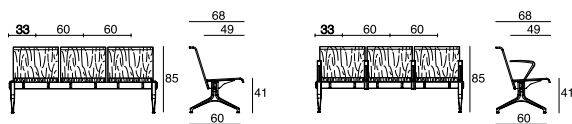

IM

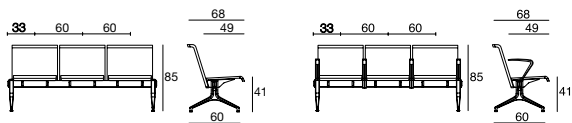

Q-44 FIX design Studio Omega

p. 180

Panca per l'attesa appartenente alla famiglia Q-44 di cui mantiene il design e le finiture. È composta da sedile e schienale fissati a una struttura metallica dedicata, realizzata in lamiera d'acciaio tagliata a laser, formando un corpo seduta unico. La seduta viene poi fissata alla trave tramite apposite piastre metalliche di fissaggio. La serie è proposta in quattro varianti: "PP" con sedile e schienale in Polipropilene in 7 colori anche in versione ignifuga CL1; "IMPP" con sedile imbottito e schienale in Polipropilene; "IM" con sedile e schienale completamente tappezzati; "W" con sedile e schienale in faggio multistrato, proposta di serie con finitura naturale (F), sbiancata (FB). Finiture della parte strutturale metallica: colore nero (N) o in colore grigio alluminio (VA).

Q44 Fix on beam is part of the wide Q44 family, matching the same design and finishing. The metal bearing seat frame is made of steel sheet duly cutted by means of laser, than bended in order to have a strong support, forming one unit with seat and backrest. The seat is fitted together with the horizontal beam by means of steel brackets and specific screws. The series is suggested with the seat in four variants: PP with seat and backrest in Polypropylene, IMPP with upholstered seat and backrest in Polypropylene, IM with upholstered seat and backrest, W with seat and backrest in beechwood with natural finishing F as standard, or FB bleached finishing as option. The metal frame of seat and beam and legs is available only in black (N) or grey aluminium (VA) colour.

Banc pour salle d'attente qui appartient à la famille Q-44 dont il maintient le design et les finitions. Il se compose d'une assise et d'un dossier fixés à une structure métallique réalisée en tôle d'acier découpée au laser, pour former le corps d'un siège unique. Le siège est ensuite fixé à la poutre à l'aide de plaques métalliques. La série est proposée en quatre versions: "PP" avec assise et dossier en Polypropylène 7 couleurs, aussi en version ignifuge CL1; "IMPP" avec assise rembourrée et dossier en Polypropylène; "IM" avec assise et dossier entièrement tapissés; "W" avec assise et dossier en hêtre multiplis, avec finition standard naturelle (F), blanchie (FB). Finitions de la structure métallique: noir (N) ou gris aluminium (VA).

Traversenbank für den Wartebereich aus der Familie Q-44 von der sie Design und Ausführungen beibehält. Sitzund Rückenschale sind an eigene Verbindungselemente aus Laser-geschnittenem Flachstahl befestigt um ein geschlossenes Teil zu bilden. Der Sitz als Ganzes wird mittels eigene Verbindungsplatten an die Traverse befestigt. Die Sitze sind in 4 Ausführungen verfügbar: "PP" mit Sitz- und Rückenschale aus Polypropylen, von den verfügbaren Farben sind 7 auch in Feuerbeständiger Ausführung KL1 lieferbar, "IMPP" mit Sitzschale gepolstert und Rückenschale aus Polypropylen, "IM" mit Sitz- und Rückenschale gepolstert und "W" mit Sitz- und Rückenschale aus Buchen-Schichtholz, serienmäßig in Natur (F) und weiß- Bleicheffekt (FB) verfügbar. Die tragenden Gestellelemente aus Metall können schwarz (N) oder aluminiumgrau (VA) beschichtet sein.

PP

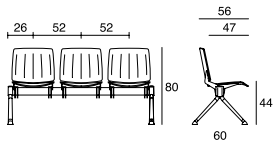

IMPP

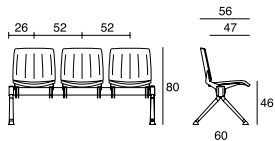

IM

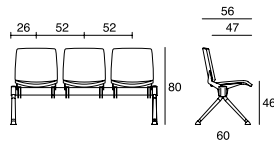

W

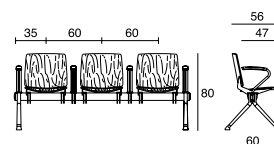
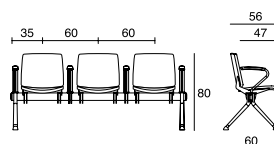
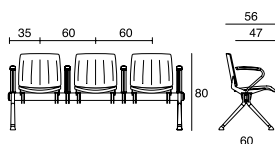
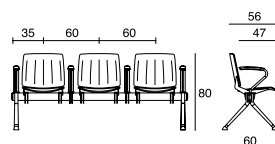
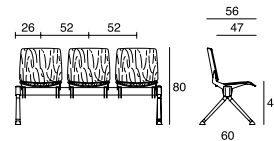

TOMMY design Alessio Pozzoli

p. 182

Programma di sedute modulari per l'attesa proposto in 3 versioni: Basic (Polipropilene), Imbottito e Faggio, mentre la versione in Cuoio è a richiesta. La struttura è modulare ed è uguale per tutte le versioni. È proposta con e senza braccioli, sia laterali che intermedi, e con travi per moduli a 1 o 2 posti. Possibilità di fissaggio a pavimento.

Modular system for waiting areas with seat available in 3 standard versions: Basic (Polypropylene), Imbottito (fully upholstered), and Faggio (beechwood), while the Cuoio (hide) version is on demand. The modular frame is the same for all versions, and it's available with or without side or intermediate arms, with 1 or 2-seater module beams. Floor-fixing is available.

Programme de sièges modulaires pour l'attente proposé en 3 versions: Basic (Polypropylène), Rembourré et Hêtre, la version en cuir est à la demande. La structure est modulaire et c'est la même pour toutes les versions. Elle est proposée avec ou sans accoudoirs, d'extrémité ou intermédiaires, et avec poutres pour modules à 1 ou 2 places. Possibilité de fixation au sol.

Modulares Sitzmöbelsystem für den Wartebereich, standardmäßig in 3 Versionen lieferbar: Basic (Polypropylen), Gepolstert und Buche. Auf Anfrage kann auch eine Version in Leder angeboten werden. Das modulare Gestell bleibt für alle Versionen gleich. Es ist mit oder ohne Armlehnen (Seitenarmlehnen und Zwischenarmlehnen) und mit Traversen für einen oder zwei Sitzplätzen lieferbar. Möglichkeit der Bodenbefestigung.

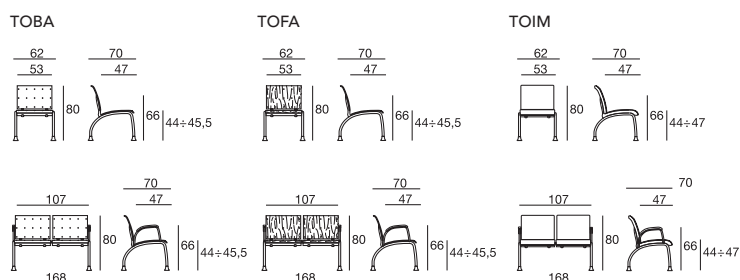

TAVOLI | TABLES | TABLES | TISCHE design UT Sesta

p. 184

Tavoli per zone ricreative o riunioni, proposti con colonna centrale oppure con struttura a 4 gambe. I tavoli con colonna centrale hanno basi di diverso tipo: a calice, piana in acciaio Inox, oppure con base a croce, proposti in più finiture. La superficie dei piani è proposta in laminato HPL con spessore 0,9 mm, mentre il bordo è sempre in ABS di diverso spessore (10 mm, 20 mm, 27 mm) in base alla tipologia del piano; oppure in vetro temperato da 10 mm. La proposta è classificata per tipologia di basamenti e strutture.

Tables for break areas or meeting rooms, suggested with central column or 4-leg frame. Tables with central column are suggested with several bases like cup-shaped base, or flat stainless steel base with square or round shape, or with cross base. Table top surface is in 0,9 mm thick HPL laminate with different edges in ABS (10 mm, 20 mm, 27 mm) or in hardened glass top 10 mm thick. The proposal of tables in that pricelist is subdivided by type of basement and frame.

Tables pour salles de détente ou de réunions, proposées avec colonne centrale ou avec structure à 4 pieds. Les tables avec colonne centrale ont plusieurs types de socles: en calice, plats en acier Inox, ou en croix, proposés en différentes finitions. Les plateaux sont en stratifié HPL de 0,9 mm d'épaisseur, avec chants en ABS de différentes épaisseurs (10 mm, 20 mm, 27 mm) selon le type de plateau; ils peuvent aussi être en verre trempé de 10 mm. L'offre est classée par types de socles et de structures.

Tische für den Regenerierungs- oder Konferenzbereich mit Mittelsäule oder 4 Beinen. Die Säulentische können mit kelchförmiger Fußplatte, flacher Fußplatte aus Edelstahl oder Fußkreuz bestückt sein. Die Tischplatte kann aus Holz, mit HPL, Stärke 0,9 mm beplankt, und einer ABS-Kante, je nach Plattenbeschaffenheit in Stärke 10 mm, 20 mm oder 27 mm, oder aus temperiertem Glas, 10 mm stark sein. Das Sortiment ist nach Gestell und Fußversionen eingeteilt.

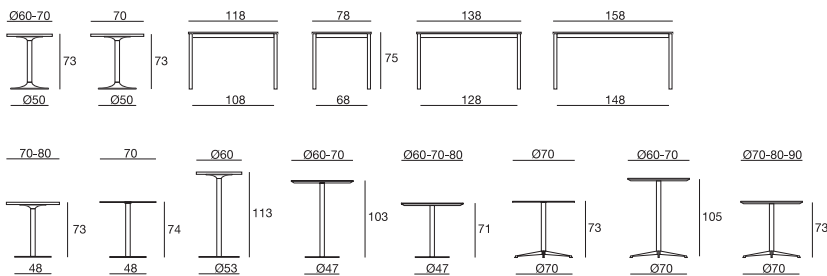

TAVOLINI | COFFEE TABLES | TABLES BASSES | BEISTELLTISCHE design UT Sesta

p. 188

Proposta plurima di tavolini per l'attesa, anche in abbinamento ad alcune serie per l'attesa della collezione. I tavolini sono proposti con più basi, a base piana oppure a 4 gambe. Top in vetro temperato oppure in laminato in vari spessori: 20, 27, 30 o 50 mm, con forma tonda, quadrata o rettangolare.

Sesta offers a vast selection of coffee tables for lounge areas, available with various finishes and sizes. The coffee tables are suggested with flat base or 4-leg frame and with laminate or glass top in squared or rectangular or round shape, with different edge thickness (20, 27, 30 and 50 mm).

Vaste offre de tables basses pour l'attente, qui peuvent aussi être associées à certaines séries pour l'attente de notre collection. Ces tables ont proposées avec plusieurs types de piètement: socle plat ou à 4 pieds. Plateau en verre trempé ou en stratifié de plusieurs épaisseurs: 20, 27, 30 o 50 mm, de forme ronde, carrée ou rectangulaire.

Umfangreiche Auswahl an Tischchen für Wartezonen, auch für die Kombination mit spezifischen Serien aus dem Sortiment. Die Tische sind mit verschiedenen Gestell und Fußvarianten lieferbar. Die Tischplatten können aus temperiertem Glas oder Holz mit Kunststofflaminat in verschiedenen Stärken: 20, 27, 30 oder 50 mm, und Formen: rund, quadratisch oder rechteckig geliefert werden.

SMILE

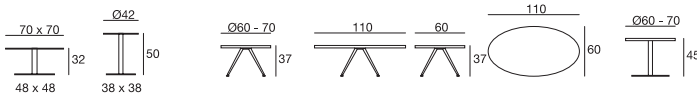

ADA3 - D&N

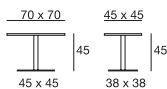

ADA4



LOLA

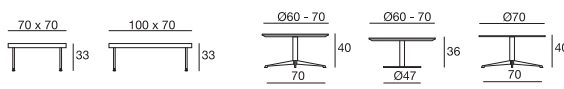

MODULO

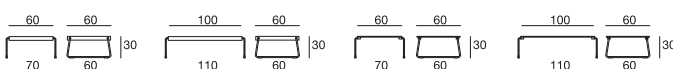

BRERA

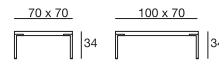



227

FINITURE

FINISHES
FINITIONS
AUSFÜHRUNGEN

METALLO | METAL | MÉTAL | METALL



N
nero
black
noir
Schwarz



BI
bianco
white
blanc
Weiß



CR
cromato
chromed
chromée
Chrom



VA
colore grigio alluminio
aluminium grey colour
couleur gris aluminium
Aluminiumgrau



VA7
grigio alluminio
aluminium grey
gris aluminium
Aluminiumgrau



ME/20
melone
melon
melon
Melone

* Q-44 Banco
Q-44 Conference
Q-44 Tip-Up

* Frank
Tavolini Paul&Frank

LEGNO | WOOD | BOIS | HOLZ

STANDARD: FINITURA SEMILUCIDA | SEMI GLOSSY FINISHING | FINITION SEMI-POLI | HALBMATT

Q2 | TA-CHERIE | Q-44 BANCO | Q-44 TIP-UP | LINATE | Q-44 FIX | TOMMY



F faggio naturale
natural colour
hêtre naturel
Buche Natur



FB faggio sbiancato
bleached colour
hêtre blanchi
Buche gebleicht



WE wengè
wengè
wengè
Wenge

* Q2 - Linate



FF: Versione con trattamento ignifugo in **Classe 1**, la certificazione è disponibile solo per una superficie pari a circa **50 sedie**. **ATTENZIONE:** Il faggio trattato con vernice ignifuga può subire un ingiallimento nel tempo quando esposto alla luce naturale.

FF: Class 1 fire retardant certificate is available only for a surface corresponding approximately to **50 chairs**. **ATTENZIONE:** the fire retardant treatment on the beechwood seats can yellow when the chairs are exposed to natural light.

FF: Version avec traitement ignifuge **Classe 1**, le certificat n'est disponible que pour une superficie égale à environ **50 chaises**. **ATTENZIONE:** le hêtre traité avec peinture ignifuge a tendance à jaunir dans le temps lorsqu'il est exposé à la lumière naturelle.

FF: Feuerfeste Ausführung **Klasse 1**, die Zertifizierung ist erst ab einer Bezugsfläche von circa **50 Stühlen** erhältlich. **ACHTUNG:** Mit feuerfestem Lack beschichtete Buche kann durch Einwirkung von Sonnenlicht mit der Zeit vergilben.

FINITURE TAVOLI | TABLE TOP FINISHINGS | FINITIONS DES PLATEAUX | TISCHAUSFÜHRUNGEN

GO MEET | GO LITE | PAUL&FRANK | MODULO | TAVOLI | TAVOLINI



LB
bianco
white
blanc
Weiß



LN
nero
black
noir
Schwarz



RC2
rovere chiaro
light oak
chêne clair
Eiche hell

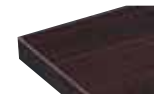

WE
wengè
wengè
wengè
Wenge



GG1
grigio chiaro
light grey
gris claire
Hellgrau



BBF
bianco bordo faggio lamellare
white top, multy layer beech edge
plateau blanc, chant hêtre lamellaire
Weiß Kante Buche Multiplex.



VNT
vetro neutro temperato
neutral tempered glass
verre neutre tempéré
Sicherheitsglas neutral



VAT
vetro acidato temperato
opal tempered glass
verre dépoli tempéré
Sicherheitsglas geätzt



VBT
vetro bianco temperato
white tempered glass
verre blanc tempéré
Sicherheitsglas weiß

Tavolini Paul&Frank:

Piano in laminato HPL da 10 mm, finitura LB o LN
HPL laminate top 10 mm thick, LB or LN finishing

Plateau en stratifié HPL épaisseur 10 mm, finition LB ou LN

Tische Paul&Frank: Platte aus 10 mm starkem HPL-Schichtstoff, Ausführung LB oder LN

* solo per | only for | seulement pour | nur für

METAL

FINITURA STRUTTURA | FRAME FINISHING | FINITION STRUCTURE | GESTELLAUSFÜHRUNG



N
nero
black
noir
Schwarz

CR
cromato
chrome
chromé
Chrom

AN 75
antracite
anthracite
gris foncé
Anthrazit

BI 10
bianco
white
blanc
Weiß

ME 20
melone
melon
melon
Melone

RO 30
rosso
red
rouge
Rot

WOOD

FINITURA STRUTTURA METALLICA E LEGNO | METAL AND WOOD FRAME FINISHING | FINITION STRUCTURE MÉTALLIQUE ET BOIS | GESTELLAUSFÜHRUNG AUS METALL UND HOLZ



CR
cromato
chrome
chromé
Chrom

BI 10
bianco
white
blanc
Weiß

AN 75
antracite
anthracite
gris foncé
Anthrazit



W
legno di tiglio tinta naturale, finitura opaca
natural-coloured linden wood, matt finishing
bois de tilleul teinté naturelle, finition mate
Lindenholz natur matt

FINITURA PIANO | TABLE TOP FINISHING | FINITION PLATEAU | AUSFÜHRUNG DER PLATTE

MELA

MELAMINICO | MELAMINE | MÉLAMINÉ | MELAMIN



BG16 (RAL 9016)
bianco
white
blanc
Weiß

BG06 (RAL 7006)
talpa
taupe
mole
Taupe

BG09 (RAL 4009)
viola
violet
violet
Violett

SUPERFICIE IN LAMINATO HPL | HIGH PRESSURE LAMINATE (HPL) SURFACE | SUPERFICIE EN STRATIFIÉ HPL | OBERFLÄCHE AUS HPL-LAMINAT



LN
nero
black
noir
Schwarz

RC2
rovere chiaro
light oak
chêne clair
Eiche hell

Piani in melaminico in 3 colori finitura opaca, mentre il colore nero e il rovere sono in laminato HPL con finitura semilucida, bordo abs da 20 mm in tinta.

Melamine tops in three colours with matt finishing, whereas the black and oak options are in HPL with semi-polished finishing, 20-mm ABS edging in the same colour. Plans en mélaminé en 3 couleurs finition mate; le noir et le chêne sont en stratifié HPL avec finition semi-brillante, bande de chant abs de 20 mm assortie.

Platten aus Melamin in 3 Mattfarben, die Ausführungen in schwarz und Eiche sind dagegen aus halbgläzendem HPL-Laminat mit gleichfarbiger 20 mm ABS-Kante.

LAC

MDF LACCATO OPACO | MATT LACQUERED MDF | MDF LAQUÉ MATE | MDF LACKIERT MATT



L1 (RAL 7005)
laccato antracite
lacquered anthracite
laqué gris foncé
lackiert anthrazit

L2 (RAL 9010)
laccato bianco
lacquered white
laqué blanc
lackiert weiß

PU

SEDUTA SGABELLO IN POLIURETANO | POLYURETHANE STOOL SEAT | ASSISE DU TABOURET EN POLYURÉTHANE | HOCKERSITZ AUS POLYURETHAN



PU13
crema
cream
crème
creme

PU23
giallo
yellow
jaune
Gelb

PU77
arancio
orange
orange
Orange

PU32
rosso
red
rouge
Rot

PU04
talpa
taupe
mole
Taupe

PU24
antracite
anthracite
gris foncé
Anthrazit

Poliuretano integrale morbido ignifugo ad elevata resistenza ai colpi e al graffio avente densità 250 Kg/m³ - colore nella massa.

Skin integral soft Polyurethane fire retardant foam with high shock and scratches resistance, 250 Kg/m³ density - mass coloured.

Mousse souple de Polyuréthane Intégrale ignifuge avec haute résistance aux coups et griffures, densité 250 Kg/m³ - coloré dans la masse.

Weiches, feuerfestes Vollpolyurethan mit hoher Schlag- und Kratzfestigkeit durch eine Dichte von 250 Kg/m³ - durchgehend eingefärbt.

POLIPROPILENE | POLYPROPYLENE | POLYPROPYLÈNE | POLYPROPYLEN

CALIBRA LIGHT



CM/71	crema cream crème Crème	AR/75	arancio orange orange Orange	RO/32	rosso red rouge Rot	AZ/52	azzurro light blue bleu ciel Azurblau	BL/47	blu blue bleu Blau	GR/19	grigio grey gris Grau	GR/35	grigio chiaro light grey gris clair Hellgrau	AN/29	antracite anthracite gris foncé Anthrazit
-------	----------------------------------	-------	---------------------------------------	-------	------------------------------	-------	--	-------	-----------------------------	-------	--------------------------------	-------	---	-------	--



NE/09	nero black noir Schwarz
-------	----------------------------------

FRILL / NOFRILL



FBI5	bianco white blanc Weiß	FSA6	sabbia sand sable Sand	FGI3	giallo yellow jaune Gelb	FAR2	arancio orange orange Orange	FRO7	rosso red rouge Rot	FAZ1	azzurro light blue bleu ciel Azurblau	FAV8	avio navy bleu marine avio-blau	FAN4	antracite anthracite gris foncé Anthrazit
------	----------------------------------	------	---------------------------------	------	-----------------------------------	------	---------------------------------------	------	------------------------------	------	--	------	--	------	--

* Non disponibile per NOFRILL | Not available for NOFRILL | Non disponible pour NOFRILL | Non disponibile per NOFRILL



Si intende versione ignifuga: CL1. | Fire retardant version: CL1. | C'est la version ignifuge: CL1. | Feuerfeste Ausführung: KL1.

Q-44 | Q-44 FIX



CM/71	crema cream crème Crème	SA/36	sabbia sand sable Sand	AR/75	arancio orange orange Orange	RO/32	rosso red rouge Rot	BL/47	blu blue bleu Blau	GR/19	grigio grey gris Grau	NE/09	nero black noir Schwarz
-------	----------------------------------	-------	---------------------------------	-------	---------------------------------------	-------	------------------------------	-------	-----------------------------	-------	--------------------------------	-------	----------------------------------



Si intende versione ignifuga: CL1 (Classe 1 IT) e M2 (non feu FR). | Fire retardant version: CL1 (Class 1 IT) and M2 (non feu FR). | C'est la version ignifuge: CL1 (Classe 1 IT) et M2 (non feu FR). | Feuerfeste Ausführung: CL1 (Klasse 1 IT) und M2 (non feu FR).

Q-44 BANCO | Q-44 TIP-UP



CM/71	crema cream crème Crème	AR/75	arancio orange orange Orange	RO/32	rosso red rouge Rot	BL/47	blu blue bleu Blau	GR/19	grigio grey gris Grau	NE/09	nero black noir Schwarz
-------	----------------------------------	-------	---------------------------------------	-------	------------------------------	-------	-----------------------------	-------	--------------------------------	-------	----------------------------------



Si intende versione ignifuga: CL1 (Classe 1 IT) e M2 (non feu FR). | Fire retardant version: CL1 (Class 1 IT) and M2 (non feu FR). | C'est la version ignifuge: CL1 (Classe 1 IT) et M2 (non feu FR). | Feuerfeste Ausführung: CL1 (Klasse 1 IT) und M2 (non feu FR).

Q-EASY XL | Q-FOUR XL | Q-GO XL | Q-44XL | Q-EASY | Q-FOUR | Q-GO | Q-44



CM/71	crema cream crème Crème	GR/19	grigio grey gris Grau	NE/09	nero black noir Schwarz
-------	----------------------------------	-------	--------------------------------	-------	----------------------------------

POLIPROPILENE | POLYPROPYLENE | POLYPROPYLÈNE | POLYPROPYLEN

EASYGO

						
CM/71	AR/75	RO/32	AZ/52	BL/47	GR/19	NE/09
crema cream crème Crème	arancio orange orange Orange	rosso red rouge Rot	azzurro light blue bleu ciel Azurblau	blu blue bleu Blau	grigio grey gris Grau	nero black noir Schwarz

 Si intende versione ignifuga: **CL1** (Classe 1 IT) e **M2** (non feu FR). | Fire retardant version: **CL1** (Class 1 IT) and **M2** (non feu FR). | C'est la version ignifuge: **CL1** (Classe 1 IT) et **M2** (non feu FR). | Feuerfeste Ausführung: **CL1** (Klasse 1 IT) und **M2** (non feu FR).

CARINA | CARINA SKID | CARINA BASKET

							
CM/71	SA/36	LI/04	AR/75	MA/73	RO/32	AZ/52	BL/47
crema cream crème Crème	sabbia sand sable Sand	giallo yellow jaune Gelb	arancio orange orange Orange	mango mango mangue Mango	rosso red rouge Rot	azzurro light blue bleu ciel Azurblau	blu blue bleu Blau
							
VZ/82	VA/06	GR/35	GR/19	AN/29	NE/09		
zolfo sulphur soufre Schwefel	verde a. b. green vert lime Wassergrün	grigio chiaro light grey gris clair Hellgrau	grigio grey gris Grau	antracite anthracite gris foncé Anthrazit	nero black noir Schwarz		

 Si intende versione ignifuga: **CL1** (Classe 1 IT) e **M2** (non feu FR). Per altri colori in Classe 1, o M2 ordine minimo 100 pz. | Fire retardant version: **CL1** (Class 1 IT) and **M2** (non feu FR). For other colours in Class 1, or M2, 100 pieces minimum order is required. | C'est la version ignifuge: **CL1** (Classe 1 IT) et **M2** (non feu FR). Pour d'autres couleurs Classe 1, ou **M2** commande minimum 100 pièces. | Feuerfeste Ausführung: **CL1** (Klasse 1 IT) und **M2** (non feu FR). Für andere Farben in Klasse 1 oder M2 Mindestbestellzahl 100 St.

TOMMY

						
CM/71	AR/75	RO/32	AZ/52	BL/47	GR/19	NE/09
crema cream crème Crème	arancio orange orange Orange	rosso red rouge Rot	azzurro light blue bleu ciel Azurblau	blu blue bleu Blau	grigio grey gris Grau	nero black noir Schwarz

 Si intende versione ignifuga: **CL2** (Classe 2 IT). | Fire retardant version: **CL2** (Class 2 IT) | C'est la version ignifuge: **CL2** (Classe 2 IT) | Feuerfeste Ausführung: **CL2** (Klasse 2 IT).

POLIETILENE | POLYETHYLENE | POLYÉTHYLÈNE | POLYETHYLEN

DAY&NIGHT

							
GI900	AR822	RO204	AZ150	VE662	GR221	CA804	AN870
giallo yellow jaune Gelb	arancio orange orange Orange	rosso red rouge Rot	azzurro light blue bleu ciel Azurblau	verde green vert grün	grigio grey gris Grau	castoro beaver castors Biber	antracite anthracite gris foncé Anthrazit



COMPETENZA E DESIGN NEL RISPETTO DELL'AMBIENTE.

Efficienza e sviluppo produttivo nel rispetto dell'ambiente per migliorare la qualità dei nostri prodotti grazie al mantenimento di un efficace Sistema di Gestione Ambientale secondo i requisiti della UNI EN ISO 14001 integrandolo nel SGQ secondo la ISO 9001.

COMPETENCE AND DESIGN WITH RESPECT FOR THE ENVIRONMENT.

Environment-oriented, efficiency and production development to improve the quality of our products through our effective Environmental Management System, meeting UNI EN ISO 14001 requirements and incorporating it into the QMS according to ISO 9001.

COMPETENCE ET DESIGN DANS LE RESPECT DE L'ENVIRONNEMENT.

L'efficience et le processus de production qui se développe dans le respect de l'environnement améliorent la qualité de nos produits grâce à l'établissement d'un Système de Gestion de l'Environnement efficace qui répond aux critères de la norme UNI EN ISO 14001 en l'intégrant dans le SGQ selon la norme ISO 9001.

KOMPETENZ UND DESIGN IM UMWELTSCHUTZ.

Umweltverträgliche Effizienz und Produktionsentwicklung zur Qualitätsverbesserung unserer Artikel durch die Pflege eines wirksamen Umweltmanagements nach UNI EN ISO 14001 und dessen Integration in das Qualitätssystem nach ISO 9001.



Le illustrazioni hanno solo valore indicativo. La proprietà, la realizzazione e riproduzione delle caratteristiche estetiche e costruttive qui illustrate sono riservate a termini di legge. I colori hanno valore indicativo in quanto soggetti alle tolleranze dei processi di stampa.

These pictures have only an approximate value. The property, the realization and the reproduction of the aesthetic and constructive characteristics, here illustrated, are reserved by law. Colours are indicative as they are subject to the alterations of the printing process.

Ces illustrations sont seulement indicatives. La propriété, la réalisation et la reproduction des caractéristiques esthétiques et de construction ci-illustrées sont réservées selon la loi. Les coloris sont seulement indicatifs dès qu'ils peuvent subir des modifications de ton pendant le processus d'imprimerie.

Die Abbildungen in diesem Katalog sind indikativ. Das geistige Eigentum, die Fertigung und Reproduktion der abgebildeten Produkte ist gesetzlich geschützt. Die abgebildeten Farben der Produkte sind durch den Druck indikativ und können von der Realität abweichen.

Sesta Srl
via Lombardia 32
26854 Cornegliano Laudense (Lodi) Italy
tel. +39 0371 483158
fax +39 0371 483178
info@sesta.it
www.sesta.it www.blogconcept.sesta.it



ROOM
Luxembourg

ROOM Luxembourg S.à r.l.
11, Um Lënsterbiërg
L-6125 Junglinster

+352 288 00 11
www.room-luxembourg.lu
info@room-luxembourg.lu