

Luxury living

# Divinitas #1



**DOMINGO**<sup>®</sup>

Luxury living

# Divinitas

DOMINGO®

**Divinitas**, proposte di arredo raffinate per ambienti eleganti, prodotte artigianalmente seguendo la tradizione della migliore manifattura italiana.

**Divinitas** è un catalogo di divani, poltrone e complementi liberamente ispirati all'universo mitologico classico, con nomi di ninfe ed eroi, figli di dei che hanno tramandato loro la natura "divina" e reminiscenze dell'arte rinascimentale e neoclassica improntata a ideali di bellezza assoluta e alla perfezione.

**Divinitas**, refined furnishings for elegant spaces, handcrafted according to the best Italian tradition.

**Divinitas** is a collection of sofas, armchairs and selected accessories reminiscent of the ideals of absolute beauty and perfection as defined by Renaissance and Neoclassical Art. The names of all featured items are borrowed from nymphs and heroes who were the offspring of Gods, therefore semi-divine.

**Divinitas**, изысканная мебель для элегантных интерьеров, изготовленная в лучших традициях итальянского ручного мастерства.

**Divinitas** — это каталог диванов, кресел и других предметов интерьера, лейтмотивно перекликающихся с миром классической мифологии своими названиями по именам нимф и героев, - детей богов, перенесших на эту мебель своё божественное совершенство, - и с искусством эпохи Ренессанса и неоклассицизма, в основе которого лежит идеал абсолютной красоты.

<b>Thalia</b>	9		
<b>Dione</b>	51	Pouf Poufs Пуфы	
<b>Cleio</b>	77		
<b>Nefele</b>	95		
		<b>Arke</b>	121
		<b>Dione</b>	131
		<b>Eos</b>	143
		<b>Chione</b>	153
		<b>Tara</b>	163
		Tavoli Tables Столики	
<b>Febe</b>	175	Finiture Finishings отделка	202
<b>Ceo</b>	183	Tessuti e pelli Fabrics and leathers Ткани и кожа	205
<b>Teti</b>	189		
<b>Rea</b>	195		

Divani  
Sofas  
Диваны

**Thalia** 9

**Dione** 51

**Cleio** 77

**Nefele** 95



Pouf  
Poufs  
Пуфы

**Arke** 121

**Dione** 131

**Eos** 143

**Chione** 153



**Tara** 163



Tavoli  
Tables  
Столики

**Febe** 175

**Ceo** 183

**Teti** 189

**Rea** 195





# Divani Sofas Диваны

07

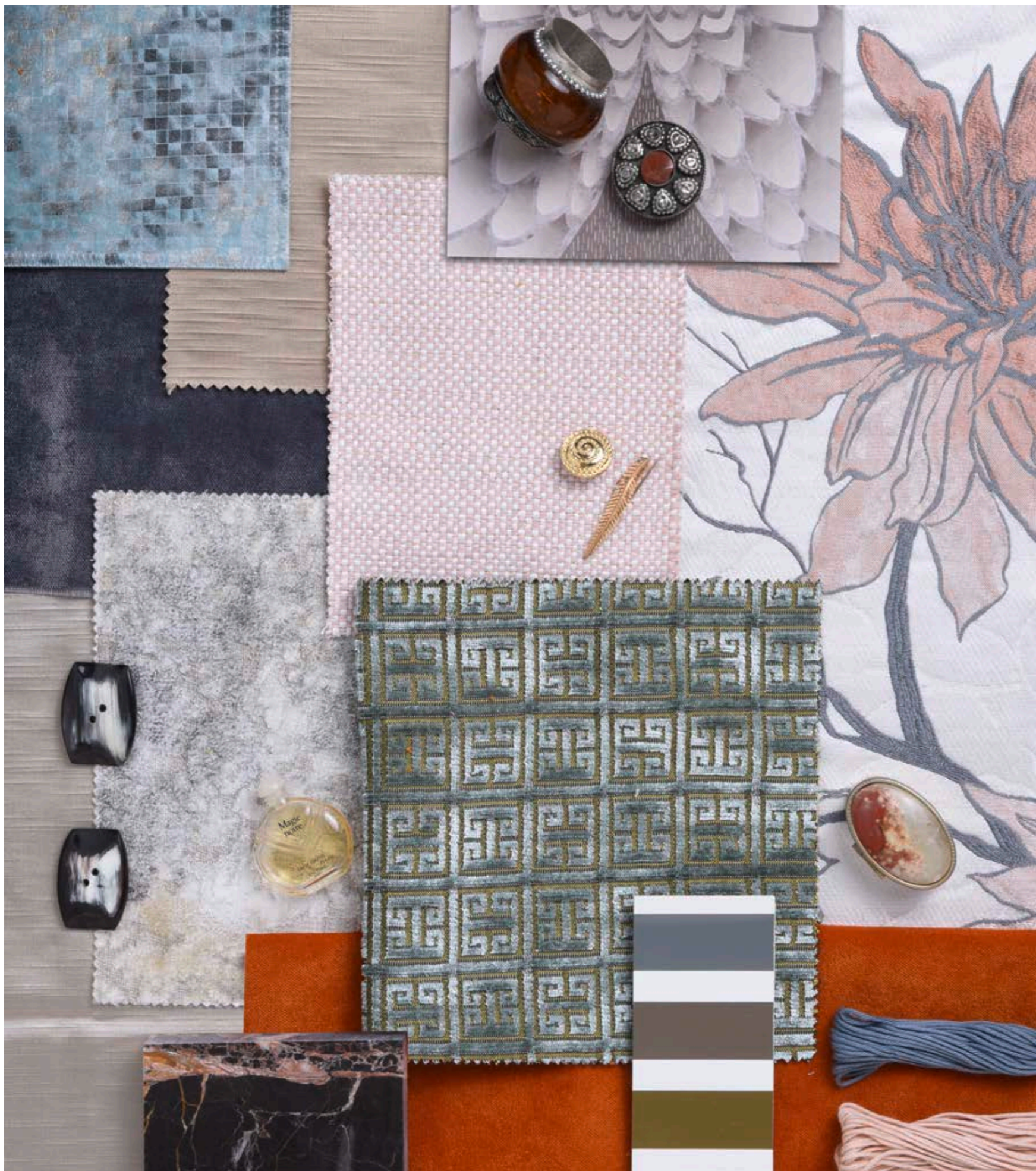

Aspetto deciso e forme imponenti ispirate a Thalia, la musa della commedia e della poesia giocosa, per una presenza che lascia il segno nell'ambiente.

Bold and imposing as the muse of comedy and playful poetry, Thalia will leave its mark wherever it stands.

Внушительные формы и четкие линии, вдохновленные Талией, - музой комедии и легкой поэзии, - накладывают свой отпечаток на интерьер.



# Thalia





**Divani Sofas Диваны**  
Domingo—Luxury

**Thalia**











**Divani Sofas Диваны**  
Domingo—Luxury

**Thalia**







Divani Sofas Диваны  
Domingo—Luxury

Thalia







**Divani Sofas Диваны**  
Domingo—Luxury

**Thalia**

















DIVANO SOFA ДИВАН
<b>3P 226x113xh123</b>
<b>4P 296x113xh123</b>

**Lavorazione schienale interno / Inside backrest version /  
Внутренняя обивка спинки**

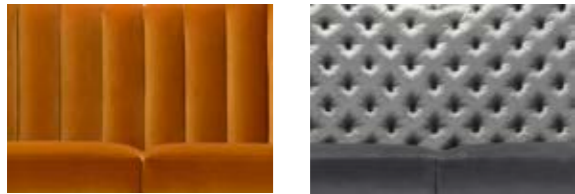

Flute

Capitonné

**Finiture laminato / Laminate finishings /  
Ламинированный деревянный цоколь**



Palette laminati  
a pag. 202  
Page 202 laminated  
frame palette  
Палитра отделок  
ламината на стр. 202

# Thalia

Struttura in multistrato di abete in vari spessori, cl. E1 a bassa emissione di formaldeide. Imbottitura in poliuretano espanso indeformabile in densità da 30 a 40 kg/m<sup>3</sup> e ovatta in poliestere. Cinghie elastiche da 80 mm. Base in legno laminato in vari colori. Resine e collanti utilizzati sono privi di sostanze ozonolesive, CFC e solventi clorurati. Tutti i materiali impiegati rispettano la normativa EU 91/156 per lo smaltimento dei rifiuti. Prodotto lavorato interamente a mano in Italia.

E1 fir plywood frame (thickness varies) featuring low formaldehyde emission. 30 to 40 kg/m<sup>3</sup> non-deformable polyurethane foam padding and polyester wadding 80 mm elastic straps. Laminated wood base (various colours available). The resins and adhesives we use are free of ozone-depleting substances, CFCs and chlorinated solvents. All the materials we use are in compliance with EU 91/156 regulations on waste disposal. Entirely handmade in Italy.

Структура - многослойная фанера из ели разной толщины класса E1 с низкой эмиссией формальдегида. Внутреннее наполнение - недеформируемый пенополиуретан плотностью от 30 до 40 кг/м<sup>3</sup> и синтепон. Эластичные ремни шириной 80 мм. Ламинированный деревянный цоколь может быть выполнен в различных цветах. Используемые типы смол и клеящих материалов не содержат озоноразрушающих веществ, хлорфторуглеродов и хлорсодержащих растворителей. Все материалы соответствуют требованиям EU 91/156 по утилизации отходов. Изделия ручной работы, полностью произведенные в Италии.

**Thalia capitonné 3P Pag. 18**



**Rivestimento / Upholstery / Обивочная ткань**  
 1-8336/5  
 2-Tivoli/67  
 3-Karma/50 Platino  
 4-19554 Don Rodrigo/72 opale



Base in laminato 2007 vg CT  
Laminata base 2007 vg CT  
Цоколь: ламинат 2007 vg CT

**Thalia decor** cuscini inclusi / included throw pillows / в комплекте с подушками



**Thalia luxury** cuscini inclusi / included throw pillows / в комплекте с подушками



La **versione decor** include cuscini decorativi in diversi colori come foto pag. 18.  
La **versione luxury** include cuscini monocromatici rivestiti con il medesimo tessuto/pelle del divano.

The **decor version** includes throw pillows made of decorative fabrics, as on page 18.  
The **luxury version** includes solid colour throw pillows upholstered with the same fabric/leather used for the sofa.

**Версия decor** включает подушки разного цвета как на фотографии стр. 18.  
**Версия luxury** включает однотонные подушки, обитые тканью/кожей того же цвета, что и диван.

**Cuscini optional** pag.17-20-21  
**Optional pillows** p. 17-20-21  
**Подушки для дополнительного заказа** - как на фото на стр. 17-20-21

- 1-8336/5
- 3-Karma/50 Platino



**Thalia capitonné 4P Pag. 10**



**Rivestimento / Upholstery / Обивочная ткань**  
 1-Basic/443 Mauritius  
 2-Tivoli/29  
 3-Orfeo F7292/01 Mint  
 4-Vegas Velvet Plain 1403/02  
 5-Vegas Velvet Plain 1403/61



Base in laminato 2006 vg LUC  
Laminata base 2006 vg LUC  
Цоколь: ламинат 2006 vg LUC

**Thalia decor** cuscini inclusi / included throw pillows / в комплекте с подушками



**Thalia luxury** cuscini inclusi / included throw pillows / в комплекте с подушками



La **versione decor** include cuscini decorativi in diversi colori come foto pag. 10.  
La **versione luxury** include cuscini monocromatici rivestiti con il medesimo tessuto/pelle del divano.

The **decor version** includes throw pillows made of decorative fabrics, as on page 10.  
The **luxury version** includes solid colour throw pillows upholstered with the same fabric/leather used for the sofa.

**Версия decor** включает подушки разного цвета как на фотографии стр. 10.  
**Версия luxury** включает однотонные подушки, обитые тканью/кожей того же цвета, что и диван.

**Thalia flute 3P** Pag. 36



Rivestimento / Upholstery / Обивочная ткань  
 1 - G075/338  
 2 - Tivoli/11  
 3 - Small velvet/45076



Base in laminato 4485 GHI  
 Laminate base 4485 GHI  
 Цоколь: ламинат 4485 GHI

**Thalia decor** cuscini inclusi / included throw pillows / в комплекте с подушками

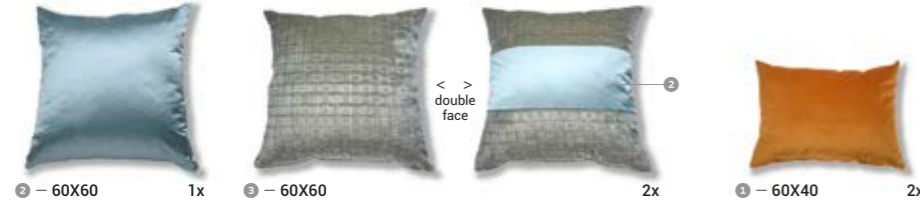

**Thalia luxury** cuscini inclusi / included throw pillows / в комплекте с подушками



La **versione decor** include cuscini decorativi in diversi colori come foto pag. 36. La **versione luxury** include cuscini monocromatici rivestiti con il medesimo tessuto/pelle del divano.

The **decor version** includes throw pillows made of decorative fabrics, as on page 36. The **luxury version** includes solid colour throw pillows upholstered with the same fabric/leather used for the sofa.

**Версия decor** включает подушки разного цвета как на фотографии стр. 36. **Версия luxury** включает однотонные подушки, обитые тканью/кожей того же цвета, что и диван.

**Thalia flute 3P** Pag. 31



Rivestimento / Upholstery / Обивочная ткань  
 1 - Nabuk/03  
 2 - Tivoli/08  
 3 - Tivoli/64  
 Filetto Piping Кант: Tivoli/29



Base in laminato 2003 vg SAT  
 Laminate base 2003 vg SAT  
 Цоколь: ламинат 2003 vg SAT

**Thalia decor** cuscini inclusi / included throw pillows / в комплекте с подушками



**Thalia luxury** cuscini inclusi / included throw pillows / в комплекте с подушками



La **versione decor** include cuscini decorativi in diversi colori come foto pag. 31. La **versione luxury** include cuscini monocromatici rivestiti con il medesimo tessuto/pelle del divano.

The **decor version** includes throw pillows made of decorative fabrics, as on page 31. The **luxury version** includes solid colour throw pillows upholstered with the same fabric/leather used for the sofa.

**Версия decor** включает подушки разного цвета как на фотографии стр. 31. **Версия luxury** включает однотонные подушки, обитые тканью/кожей того же цвета, что и диван.

**Thalia flute 4P** Pag. 42-45



Rivestimento / Upholstery / Обивочная ткань  
 1 - Moon/651  
 Rosa antico  
 2 - Brooklin/07  
 3 - Kauai Blush F1299/01  
 4 - 19552 Dalia/90



Base in laminato 2008 vg SAT  
 Laminate base 2008 vg SAT  
 Цоколь: ламинат 2008 vg SAT

**Thalia decor** cuscini inclusi / included throw pillows / в комплекте с подушками



**Thalia luxury** cuscini inclusi / included throw pillows / в комплекте с подушками



La **versione decor** include cuscini decorativi in diversi colori come foto pag. 42-45. La **versione luxury** include cuscini monocromatici rivestiti con il medesimo tessuto/pelle del divano.

The **decor version** includes throw pillows made of decorative fabrics, as on page 42-45. The **luxury version** includes solid colour throw pillows upholstered with the same fabric/leather used for the sofa.

**Версия decor** включает подушки разного цвета как на фотографии стр. 42-45. **Версия luxury** включает однотонные подушки, обитые тканью/кожей того же цвета, что и диван.

**Cuscini optional** pag.44  
**Optional pillows** p.44  
**Подушки для дополнительного заказа** - как на фото на стр. 44

- 1 - Kauai Blush F1299/01
- 2 - 19552 Dalia/90



**Thalia flute 4P** Pag. 26-27-28



Rivestimento / Upholstery / Обивочная ткань  
 1 - Vegas Velvet Plain 1403/78  
 2 - Java Putty F0496/41  
 3 - La Moulade NCF4280/05 Blue/Linen  
 4 - Java Sesame F0496/45



Base in laminato 2006 vg LUC  
 Laminate base 2006 vg LUC  
 Цоколь: ламинат 2006 vg LUC

**Thalia decor** cuscini inclusi / included throw pillows / в комплекте с подушками



**Thalia luxury** cuscini inclusi / included throw pillows / в комплекте с подушками



La **versione decor** include cuscini decorativi in diversi colori come foto pag. 26-27-28. La **versione luxury** include cuscini monocromatici rivestiti con il medesimo tessuto/pelle del divano.

The **decor version** includes throw pillows made of decorative fabrics, as on page 26-27-28. The **luxury version** includes solid colour throw pillows upholstered with the same fabric/leather used for the sofa.

**Версия decor** включает подушки разного цвета как на фотографии стр. 26-27-28. **Версия luxury** включает однотонные подушки, обитые тканью/кожей того же цвета, что и диван.

**Cuscini optional** pag.23-24-25  
**Optional pillows** p.23-24-25  
**Подушки для дополнительного заказа** - как на фото на стр. 23-24-25

- 1 - Vegas Velvet Plain 1403/78
- 2 - Java Putty F0496/41

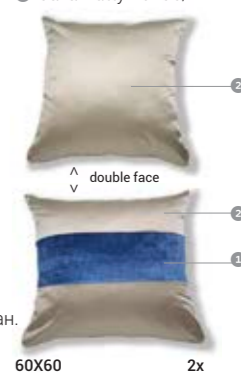



Rotondità sinuose  
impresiosite da decori discreti,  
proposte colore delicate  
e senza tempo per Dione,  
una collezione ispirata  
alla dea dell'amore, dell'acqua  
e del cielo luminoso.

Sinuous curves embellished  
by sober decorations  
and delicate timeless hues  
for Dione, the series inspired  
by the goddess of love,  
water and clear skies.

Мягкие округленные  
формы, украшенные  
сдержанным декором,  
нежные и неподвластные  
времени цвета  
для коллекции Dione,  
вдохновленной  
богиней любви, воды  
и ясного неба.



# Dione





**Divani Sofas Диваны**  
Domingo—Luxury

**Dione**











**Divani Sofas Диваны**  
Domingo—Luxury

**Dione**







POLTRONA ARMCHAIR ДИВАН	DIVANO SOFA ДИВАН	POUF POUF ПУФ
Small 80x85xh94	3P 242x118xh97 	Sm D50xh45
Light 80x85xh94		Md D70xh45
Large 118x118xh97		Bc 120x45xh45

### Finiture base / Base finishings / Отделки базы



Con frangia  
With fringe  
С бахромой



Senza frangia  
Without fringe  
Без бахромы

# Dione

Struttura in multistrato di abete in vari spessori, cl. E1 a bassa emissione di formaldeide. Imbottitura in poliuretano espanso indeformabile in densità da 30 a 40 kg/m<sup>3</sup> e ovatta in poliestere. Cinghie elastiche da 80 mm. Versione letto con sistema di apertura rapida a due pieghe, rete elettrosaldata e materasso h 12 cm. Frangia in filato di organzino. Resine e collanti utilizzati sono privi di sostanze ozonolesive, CFC e solventi clorurati. Tutti i materiali impiegati rispettano la normativa EU 91/156 per lo smaltimento dei rifiuti.

E1 fir plywood frame featuring low formaldehyde emission. 30 to 40 kg/m<sup>3</sup> non-deformable polyurethane foam padding and polyester wadding 80 mm elastic straps. The sofa-bed version features a quick two-fold opening system, electro-welded mesh two fold and 12 cm height mattress. Fringe in organzine yarn. The resins and adhesives we use are free of ozone-depleting substances, CFCs and chlorinated solvents. All the materials we use are in compliance with EU 91/156 regulations on waste disposal.

Структура - многослойная фанера из ели разной толщины класса E1 с низкой эмиссией формальдегида. Внутреннее наполнение - недеформируемый пенополиуретан плотностью от 30 до 40 кг/м<sup>3</sup> и синтепон. Эластичные ремни шириной 80 мм. Версия со спальным местом имеет механизм быстрого раскладывания в два приема, электросварную сетку и матрас см h12. Бахрома - шелковая глянцевая пряжа. Используемые типы смол и клеящих материалов не содержат озоноразрушающих веществ, хлорфторуглеродов и хлорсодержащих растворителей. Все материалы соответствуют требованиям EU 91/156 по утилизации отходов.



### Dione light 1P

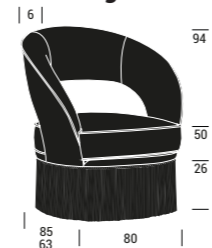

### Pag. 64



**Rivestimento / Upholstery / Обивочная ткань**  
 ①-G075/857  
 ②-Frangia fringe Бахрома h26/9R STD  
 Chiodini in oro invecchiato  
 Aged golden nails  
 Заклепки под состарившееся золото



**Rivestimento / Upholstery / Обивочная ткань**  
 ①-G075/102  
 Filetto Piping Кант: G075/234  
 ②-Frangia fringe Бахрома h26/2R STD  
 Chiodini in oro invecchiato  
 Aged golden nails  
 Заклепки под состарившееся золото

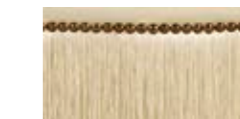

**Rivestimento / Upholstery / Обивочная ткань**  
 ①-G075/234  
 Filetto Piping Кант: G075/102  
 ②-Frangia fringe Бахрома h26/2R STD  
 Chiodini in oro invecchiato  
 Aged golden nails  
 Заклепки под состарившееся золото



### Dione small 1P

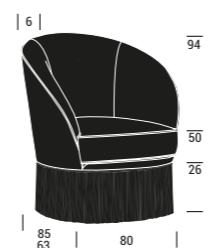

### Pag. 64



**Rivestimento / Upholstery / Обивочная ткань**  
 ①-G075/230  
 ②-Frangia fringe Бахрома h26/10R STD  
 Chiodini in oro invecchiato  
 Aged golden nails  
 Заклепки под состарившееся золото



**Rivestimento / Upholstery / Обивочная ткань**  
 ①-G075/312  
 ②-Frangia fringe Бахрома h26/11R STD  
 Chiodini in oro invecchiato  
 Aged golden nails  
 Заклепки под состарившееся золото



**Rivestimento / Upholstery / Обивочная ткань**  
 ①-G075/462  
 ②-Frangia fringe Бахрома h26/57R STD  
 Chiodini in oro invecchiato  
 Aged golden nails  
 Заклепки под состарившееся золото



### Dione large 1P

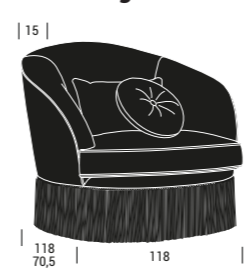

### Pag. 62



**Rivestimento / Upholstery / Обивочная ткань**  
 ①-Lux/2408  
 ②-Frangia fringe Бахрома h26/29R STD  
 ③-80723 Crusca/46 Rame rosato  
 ④-Java Coccoa F0496/08 Bottone Button Пуговица: Lux/2408  
 Chiodini in oro invecchiato  
 Aged golden nails  
 Заклепки под состарившееся золото

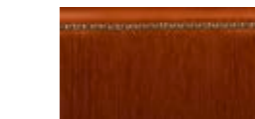

La **versione decor** include cuscini decorativi in diversi colori come foto pag. 62-63. La **versione luxury** include cuscini monocromatici rivestiti con il medesimo tessuto/pelle del divano.

The **decor version** includes throw pillows made of decorative fabrics, as on page 62-63.

The **luxury version** includes solid colour throw pillows upholstered with the same fabric/leather used for the sofa.

Версия **decor** включает подушки разного цвета как на фотографии стр. 62-63. Версия **luxury** включает однотонные подушки, обитые тканью/кожей того же цвета, что и диван.

**Divani Sofas Диваны**  
Domingo—Luxury

### Pag. 63

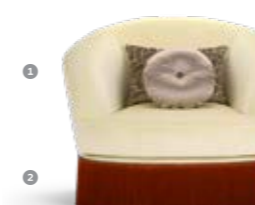

**Rivestimento / Upholstery / Обивочная ткань**  
 ①-G075/102  
 ②-Frangia fringe Бахрома h26/29R STD  
 ③-Vimini/44  
 ④-Java Putty F0496/41 Bottone Button Пуговица: Java Coccoa F0496/08  
 Chiodini in oro invecchiato  
 Aged golden nails  
 Заклепки под состарившееся золото



Dione

### Dione decor



① - 60X40 1x



④ - Ø45 1x

cuscini inclusi / included throw pillows / в комплекте с подушками

### Dione luxury



① - 60X40 1x

cuscini inclusi / included throw pillows / в комплекте с подушками

### Dione decor



① - 60X40 1x



④ - Ø45 1x

cuscini inclusi / included throw pillows / в комплекте с подушками

### Dione luxury



① - 60X40 1x

cuscini inclusi / included throw pillows / в комплекте с подушками

**Dione 3P** Pag. 56



**Rivestimento / Upholstery / Обивочная ткань**  
 1-G075/234  
 2-Frangia fringe Бахрома h26/72R STD  
 3-Diamond Luxury/01  
 4-Mirage Luxury/01  
 5-Java Moss F0496/33  
 Bottone Button Пуговица: G075/234  
 Chiodini in oro invecchiato Aged golden nails  
 Заклепки под состарившееся золото

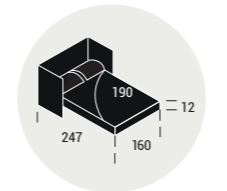

**Dione decor** cuscini inclusi / included throw pillows / в комплекте с подушками



**Dione luxury** cuscini inclusi / included throw pillows / в комплекте с подушками



La **versione decor** include cuscini decorativi in diversi colori come foto pag. 56. La **versione luxury** include cuscini monocromatici rivestiti con il medesimo tessuto/pelle del divano.

The **decor version** includes throw pillows made of decorative fabrics, as on page 56. The **luxury version** includes solid colour throw pillows upholstered with the same fabric/leather used for the sofa.

**Версия decor** включает подушки разного цвета как на фотографии стр. 56. **Версия luxury** включает однотонные подушки, обитые тканью/кожей того же цвета, что и диван.

**Dione 3P** Pag. 51-55



**Rivestimento / Upholstery / Обивочная ткань**  
 1-G075/102  
 2-Frangia fringe Бахрома h26/29R STD  
 3-Vimini/10  
 4-Java Coccoa F0496/08  
 5-Java Putty F0496/41  
 Bottone Button Пуговица: Java Coccoa F0496/08  
 Chiodini in oro invecchiato Aged golden nails  
 Заклепки под состарившееся золото

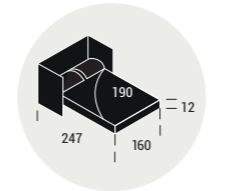

**Dione decor** cuscini inclusi / included throw pillows / в комплекте с подушками



**Dione luxury** cuscini inclusi / included throw pillows / в комплекте с подушками



La **versione decor** include cuscini decorativi in diversi colori come foto pag. 51-55. La **versione luxury** include cuscini monocromatici rivestiti con il medesimo tessuto/pelle del divano.

The **decor version** includes throw pillows made of decorative fabrics, as on page 51-55. The **luxury version** includes solid colour throw pillows upholstered with the same fabric/leather used for the sofa.

**Версия decor** включает подушки разного цвета как на фотографии стр. 51-55. **Версия luxury** включает однотонные подушки, обитые тканью/кожей того же цвета, что и диван.

**Cuscini optional** pag.52  
**Optional throw pillows** p.52  
**Подушки для дополнительного заказа** - как на фото на стр. 52  
 1-Vimini/44  
 2-Java Dove F0496/10  
 Bottone Button Пуговица: G075/102



**Dione Sm pouf** Pag. 68

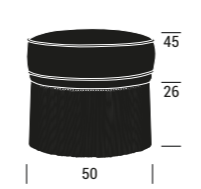

**Rivestimento / Upholstery / Обивочная ткань**  
 1-G075/102  
 2-Frangia fringe Бахрома h26/72R STD  
 Chiodini in oro invecchiato Aged golden nails  
 Заклепки под состарившееся золото



**Rivestimento / Upholstery / Обивочная ткань**  
 1-G075/102  
 2-Frangia fringe Бахрома h26/29R STD  
 Chiodini in oro invecchiato Aged golden nails  
 Заклепки под состарившееся золото



**Dione Md pouf** Pag. 68

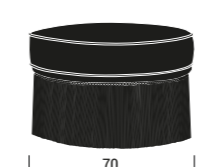

**Rivestimento / Upholstery / Обивочная ткань**  
 1-G075/208  
 2-Frangia fringe Бахрома h26/254R STD  
 Chiodini in oro invecchiato Aged golden nails  
 Заклепки под состарившееся золото



**Rivestimento / Upholstery / Обивочная ткань**  
 1-80723 Crusca/46 Rame rosato  
 2-Frangia fringe Бахрома h26/79R OPT  
 Chiodini in oro invecchiato Aged golden nails  
 Заклепки под состарившееся золото



**Dione Bc bench** Pag. 68

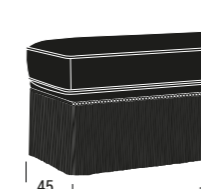

**Rivestimento / Upholstery / Обивочная ткань**  
 1-G075/456  
 2-Frangia fringe Бахрома h26/79R OPT  
 Chiodini in oro invecchiato Aged golden nails  
 Заклепки под состарившееся золото



**Rivestimento / Upholstery / Обивочная ткань**  
 1-8336/15  
 2-Frangia fringe Бахрома h26/29R STD  
 Chiodini in oro invecchiato Aged golden nails  
 Заклепки под состарившееся золото



Frangia / Fringe / Бахрома / h26 cm

STD = colori di serie / standard colours / стандартные цвета  
 OPT = colori optional / optional colours / по желанию  
 (за дополнительную плату)

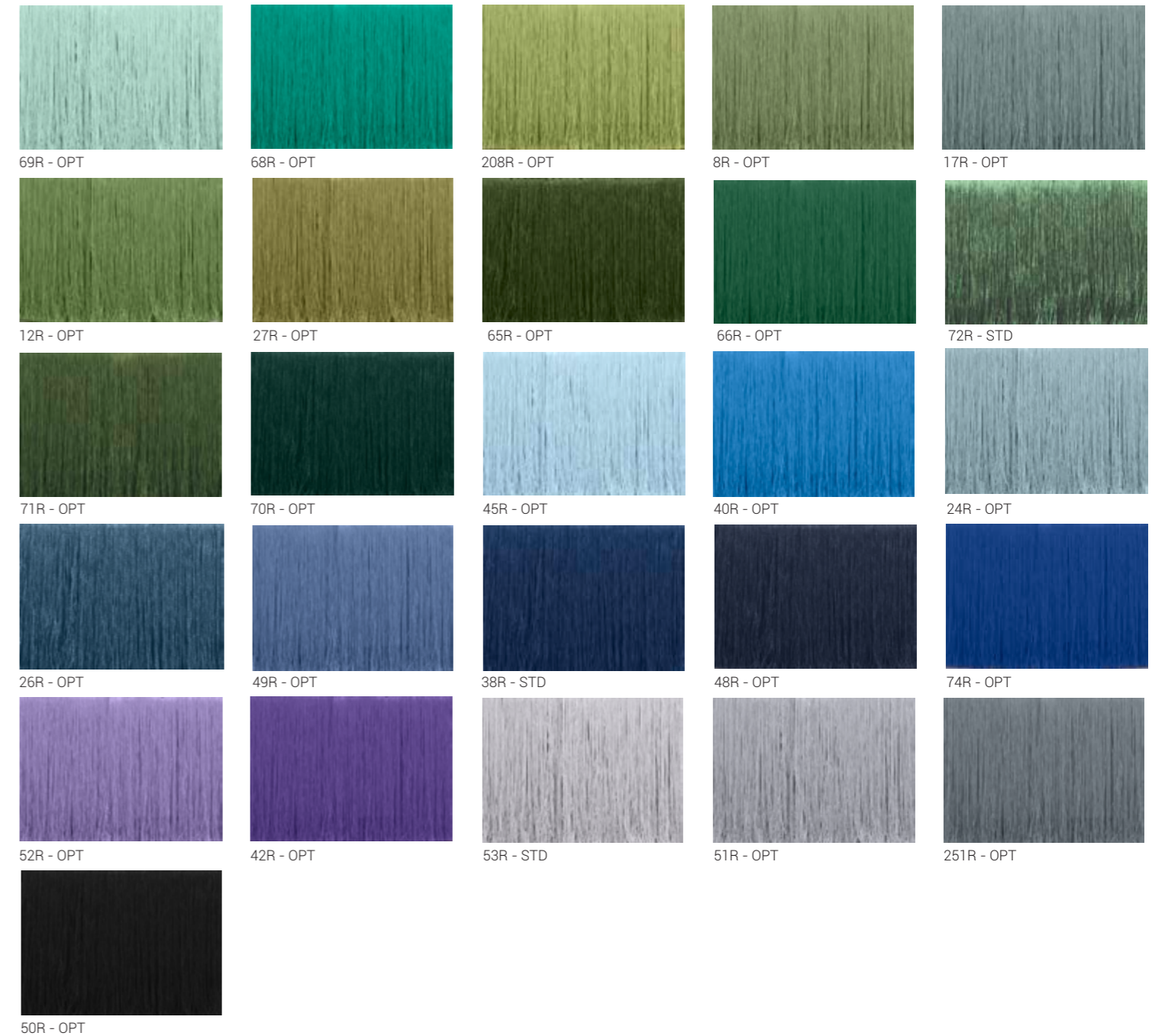

Chiodini metallici / Metal nails / Металлические заклепки





Forme classiche rivisitate  
con dettagli moderni,  
geometrie lineari  
e curve che si incontrano  
armoniosamente nelle sedute  
di Cleio, la collezione ispirata  
alla musa della storia  
e protettrice della poesia.

Modern details add charm  
and personality to classic  
shapes that harmoniously  
combine linear and round  
geometrical features to define  
Cleio, a series of sofas  
and armchairs that bears  
the name of the Muse of History  
invoked by the poets who sang  
the deeds of the great.

Классические формы с  
современными деталями,  
чистые геометрические  
линии и изгибы,  
гармонично сливающиеся  
в сиденьях коллекции Cleio,  
посвященной музе истории,  
воспетой поэтами.



# Cleio







**Divani Sofas Диваны**  
Domingo—Luxury

**Cleio**









POLTRONA ARMCHAIR КРЕСЛО	DIVANO SOFA ДИВАН
<b>Small 85x99.5xh86</b>	<b>2P 198x113xh89.5</b> 
<b>Large 110x113xh89.5</b>	<b>3P 255x113xh89.5</b> 

**Lavorazione scocca esterna / Outer shell version /  
Внешняя обивка каркаса**



Liscio  
Plain  
Гладкая

Capitonnè

**Lavorazione schienale interno / Inside backrest version /  
Внутренняя обивка спинки**



Liscio  
Plain  
Гладкая

Flute

# Cleio

Struttura in multistrato di abete in vari spessori, cl. E1 a bassa emissione di formaldeide. Imbottitura in poliuretano espanso indeformabile in densità da 30 a 40 kg/m<sup>3</sup> e ovatta in poliestere. Cinghie elastiche da 80 mm. Piedi in metallo con finitura galvanica ottone e protezione trasparente. Versione letto con sistema di apertura rapida a due pieghe, rete elettrosaldata e materasso 12 cm. Resine e collanti utilizzati sono privi di sostanze ozonolesive, CFC e solventi clorurati. Tutti i materiali impiegati rispettano la normativa EU 91/156 per lo smaltimento dei rifiuti.

E1 fir plywood frame (thickness varies) featuring low formaldehyde emission. 30 to 40 kg/m<sup>3</sup> non-deformable polyurethane foam padding and polyester wadding 80 mm elastic straps. Metal feet with galvanised brass finish and transparent protection. The resins and adhesives we use are free of ozone-depleting substances, CFCs and chlorinated solvents. The sofa-bed version features a quick two-fold opening system, electro-welded mesh two fold and 12 cm height mattress All the materials we use are in compliance with EU 91/156 regulations on waste disposal.

Структура - многослойная фанера из ели разной толщины класса E1 с низкой эмиссией формальдегида. Внутреннее наполнение – недеформируемый пенополиуретан плотностью от 30 до 40 кг/м<sup>3</sup> и синтепон. Эластичные ремни шириной 80 мм. Ножки - металл с гальванической латунной отделкой и прозрачным защитным покрытием. Используемые типы смол и клеящих материалов не содержат озоноразрушающих веществ, хлорфторуглеродов и хлорсодержащих растворителей. Версия со спальным местом имеет механизм быстрого раскладывания в два приема, электросварную сетку и матрас см h12. Все материалы соответствуют требованиям EU 91/156 по утилизации отходов.



**Cleio small plain 1P**

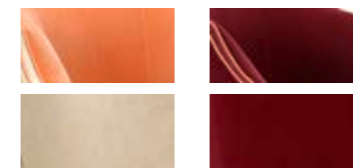
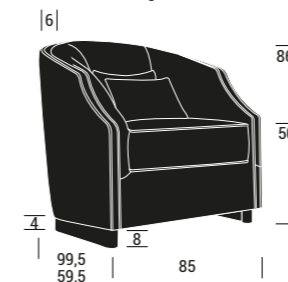

Lavorazione schienale interno-esterno liscio  
Plain inside backrest version  
Plain outer shell version  
Внутренняя и внешняя обивка спинки - гладкая

**Pag. 78**



Rivestimento / Upholstery / Обивочная ткань  
①-G075/456  
②- Fascia e schienale Band and shell  
Вставка и спинка: Karma/50 Platino  
③-19558 Renzo/50 Bronzo

Base in metallo verniciato ottone satinato  
Metal base with satin brass finish  
Цоколь – металл в цвете матовой латуни

**Pag. 78**



Rivestimento / Upholstery / Обивочная ткань  
①-G075/824  
②-G075/456

Base in metallo verniciato ottone satinato  
Metal base with satin brass finish  
Цоколь – металл в цвете матовой латуни

**Cleio large capitonnè 1P**

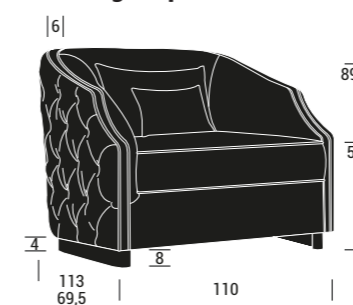

Lavorazione schienale interno liscio  
Lavorazione scocca esterna capitonnè  
Plain inside backrest version  
Capitonnè outer shell version  
Внутренняя обивка спинки - гладкая  
Внешняя обивка каркаса - каретная стяжка ("капитоне")

**Pag. 82**



Rivestimento / Upholstery / Обивочная ткань  
①-G075/416  
②-G075/414

Base in metallo verniciato ottone satinato  
Metal base with satin brass finish  
Цоколь – металл в цвете матовой латуни

La **versione decor** include cuscini decorativi in diversi colori come foto pag. 78-82. La **versione luxury** include cuscini monocromatici rivestiti con il medesimo tessuto/pelle del divano.

**Cleio decor**  
cuscini inclusi / included throw pillows / в комплекте с подушками



① – 35X25 1x ② – 35X25 1x

**Cleio luxury**  
cuscini inclusi / included throw pillows / в комплекте с подушками



① – 35X25 2x

**Cleio decor**  
cuscini inclusi / included throw pillows / в комплекте с подушками



① – 35X25 1x ② – 35X25 1x

**Cleio luxury**  
cuscini inclusi / included throw pillows / в комплекте с подушками



① – 35X25 2x

**Cleio decor**  
cuscini inclusi / included throw pillows / в комплекте с подушками



② – 60X40 1x ③ – 35X25 1x

**Cleio luxury**  
cuscini inclusi / included throw pillows / в комплекте с подушками



② – 60X40 1x ③ – 35X25 1x

The **decor version** includes throw pillows made of decorative fabrics, as on page 78-82. The **luxury version** includes solid colour throw pillows upholstered with the same fabric/leather used for the sofa.

**Версия decor** включает подушки разного цвета как на фотографии стр. 78-82. **Версия luxury** включает однотонные подушки, обитые тканью/кожей того же цвета, что и диван.

**Cleio plain 2P** Pag. 78

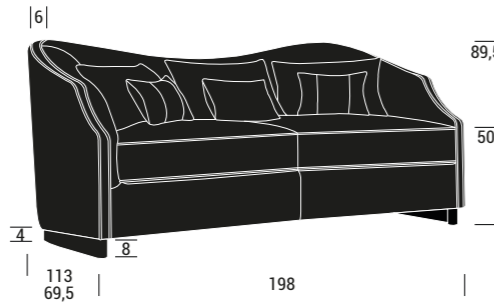

**Rivestimento / Upholstery / Обивочная ткань**  
 1-G075/456  
 2-Karma/50 Platino  
 3-19558 Renzo/50 Bronzo

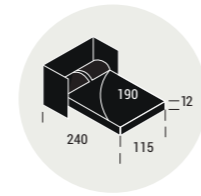

Base in metallo verniciato ottone satinato  
 Metal base with satin brass finish  
 Цоколь – металл в цвете матовой латуни



Lavorazione schienale interno-esterno liscio  
 Plain inside backrest version  
 Plain outer shell version  
 Внутренняя обивка спинки - гладкая  
 Внешняя обивка каркаса - гладкая

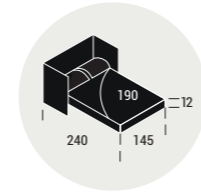

**Rivestimento / Upholstery / Обивочная ткань**  
 1-G075/208  
 2-Filetto e schienale Lux/2434  
 Piping and backrest Lux/2434  
 Кант и спинка: Lux/2434  
 3-80723 Crusca/46  
 Rame rosato  
 4-Jungle velvet 1638/07



Base in metallo verniciato ottone satinato  
 Metal base with satin brass finish  
 Цоколь - металл в цвете матовой латуни

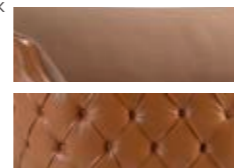

Lavorazione schienale interno liscio. Lavorazione scocca esterna capitonné  
 Plain inside backrest version  
 Capitonné outer shell version  
 Внутренняя обивка спинки - гладкая. Внешняя обивка каркаса - каретная стяжка ("капитоне")

**Cleio flute 3P** Pag. 86

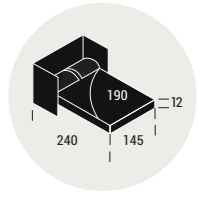
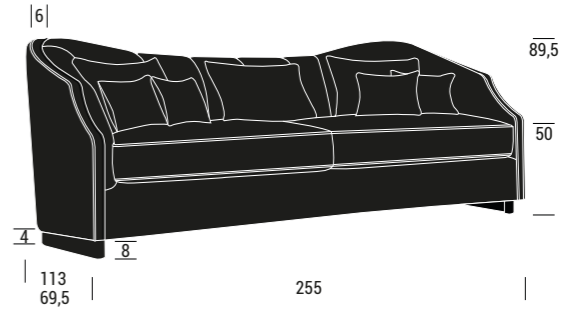

**Rivestimento / Upholstery / Обивочная ткань**  
 1-Bilbi/22  
 2-Bahamas/4  
 3-Tivoli/29



Base in metallo verniciato ottone satinato  
 Metal base with satin brass finish  
 Цоколь – металл в цвете матовой латуни



Lavorazione schienale interno fasce verticali imbottite. Lavorazione scocca esterna liscio  
 Deep fluted backrest  
 Plain outer shell version  
 Внутренняя отделка спинки - вертикальные сегменты с набивкой  
 Внешняя обивка каркаса - гладкая

**Cleio decor** cuscini inclusi / included throw pillows / в комплекте с подушками



**Cleio luxury** cuscini inclusi / included throw pillows / в комплекте с подушками



La **versione decor** include cuscini decorativi in diversi colori come foto pag. 78.  
 La **versione luxury** include cuscini monocromatici rivestiti con il medesimo tessuto/pelle del divano.

The **decor version** includes throw pillows made of decorative fabrics, as on page 78.  
 The **luxury version** includes solid colour throw pillows upholstered with the same fabric/leather used for the sofa.

**Версия decor** включает подушки разного цвета как на фотографии стр. 78.  
**Версия luxury** включает однотонные подушки, обитые тканью/кожей того же цвета, что и диван.

**Cleio capitonné 3P** Pag. 82

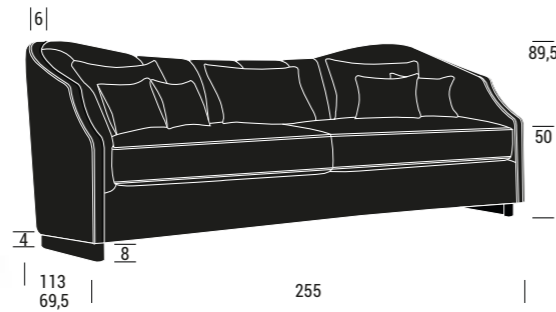

**Cleio decor** cuscini inclusi / included throw pillows / в комплекте с подушками



**Cleio luxury** cuscini inclusi / included throw pillows / в комплекте с подушками



La **versione decor** include cuscini decorativi in diversi colori come foto pag. 82.  
 La **versione luxury** include cuscini monocromatici rivestiti con il medesimo tessuto/pelle del divano.

The **decor version** includes throw pillows made of decorative fabrics, as on page 82.  
 The **luxury version** includes solid colour throw pillows upholstered with the same fabric/leather used for the sofa.

**Версия decor** включает подушки разного цвета как на фотографии стр. 82.  
**Версия luxury** включает однотонные подушки, обитые тканью/кожей того же цвета, что и диван.

**Cleio decor** cuscini inclusi / included throw pillows / в комплекте с подушками



**Cleio luxury** cuscini inclusi / included throw pillows / в комплекте с подушками



La **versione decor** include cuscini decorativi in diversi colori come foto pag. 86.  
 La **versione luxury** include cuscini monocromatici rivestiti con il medesimo tessuto/pelle del divano.

The **decor version** includes throw pillows made of decorative fabrics, as on page 86.  
 The **luxury version** includes solid colour throw pillows upholstered with the same fabric/leather used for the sofa.

**Версия decor** включает подушки разного цвета как на фотографии стр. 86.  
**Версия luxury** включает однотонные подушки, обитые тканью/кожей того же цвета, что и диван.





Protagonista assoluto, ricco di dettagli preziosi e capitonné lavorati a mano che ne esaltano la morbidezza, Nefele è ispirato alla ninfa delle nubi, creata da una nuvola grazie all'intervento di Zeus.

An absolute star, rich in sophisticated details and handmade capitonné stitches that enhance its softness, Nefele is inspired by the nymph whom Zeus created out of a cloud.

Главный элемент этой коллекции, украшенный ценными деталями, - стежка "капитоне", мягкие формы которой были созданы благодаря ручной работе; коллекция Nefele посвящена нимфе облаков, так как Нефела была создана Зевсом именно из облака.



# Nefele





**Divani Sofas Диваны**  
Domingo—Luxury

**Nefele**

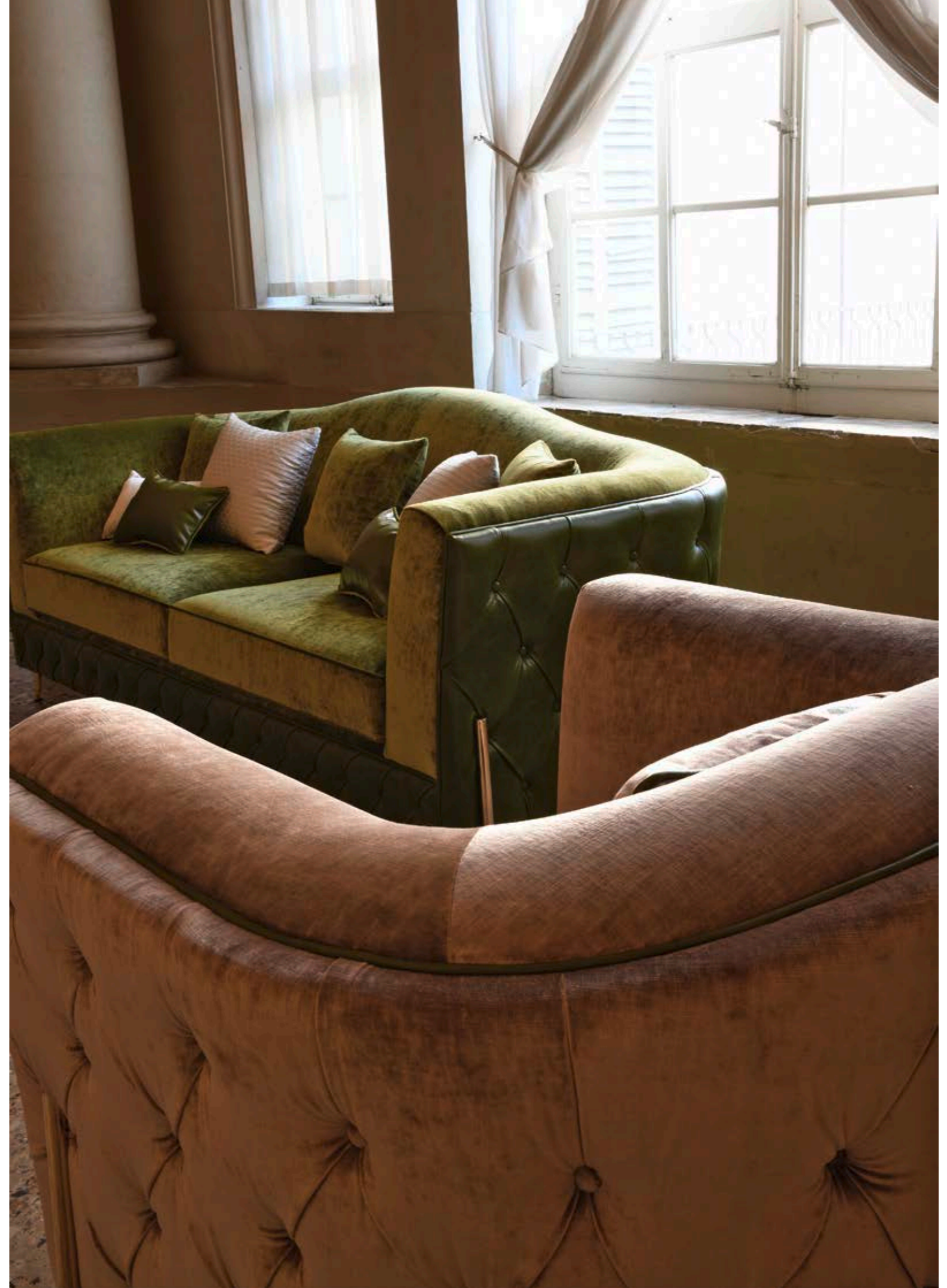















POLTRONA  
ARMCHAIR  
КРЕСЛО

1P 120x119xh95/85

DIVANO  
SOFA  
ДИВАН

3P 236x119xh95/85

4P 280x119xh95/85

### Lavorazione scocca esterna / Outer shell version / Внешняя обивка каркаса



Liscio  
Plain  
Гладкая

Capitonè

### Lavorazione schienale interno / Inside backrest version / Внутренняя обивка спинки



Liscio  
Plain  
Гладкая

Capitonè

### Piedi / Feet / Ножки



P 64 h14 cm  
Piede in metallo  
finitura ottone lucido  
Polished brass-plated  
metal legs  
Ножка – металл в  
отделке блестящая  
латунь

P 59 h 4,5 cm  
Piede in legno wengé  
Wooden feet stained wengé  
Деревянные ножки в  
цвете венге

# Nefele

Struttura in multistrato di abete in vari spessori, cl. E1 a bassa emissione di formaldeide. Imbottitura in poliuretano espanso indeformabile in densità da 30 a 40 kg/m<sup>3</sup> e ovatta in poliestere. Cinghie elastiche da 80 mm. Piedi in metallo con finitura galvanica ottone e protezione trasparente lucido. Versione letto con sistema di apertura rapida a due pieghe, rete elettrosaldata e materasso alto 12 cm. Resine e collanti utilizzati sono privi di sostanze ozonolesive, CFC e solventi clorurati. Tutti i materiali impiegati rispettano la normativa EU 91/156 per lo smaltimento dei rifiuti. Prodotto lavorato interamente a mano in Italia.

E1 fir plywood frame featuring low formaldehyde emission. 30 to 40 kg/m<sup>3</sup> non-deformable polyurethane foam padding and polyester wadding 80 mm elastic straps. Metal feet with galvanic brass finish and glossy transparent protection. The sofa-bed version features a rapid, two-fold opening system, and electro-welded mesh two fold and 12 cm height mattress. The resins and adhesives we use are free of ozone-depleting substances, CFCs and chlorinated solvents. All the materials we use are in compliance with EU 91/156 regulations on waste disposal. Entirely handmade in Italy.

Структура – многослойная фанера из ели разной толщины класса E1 с низкой эмиссией формальдегида. Внутреннее наполнение – недеформируемый пенополиуретан плотностью от 30 до 40 кг/м<sup>3</sup> и синтепон. Эластичные ремни шириной 80 мм. Ножки – металл с гальванической латунной отделкой и глянцевым прозрачным защитным покрытием. Версия со спальным местом имеет механизм быстрого раскладывания в два приема, электросварную сетку и матрас см h12. Используемые типы смол и клеящих материалов не содержат озоноразрушающих веществ, хлорфторуглеродов и хлорсодержащих растворителей. Все материалы соответствуют требованиям EU 91/156 по утилизации отходов. Изделия ручной работы, полностью произведенные в Италии.

### Nefele capitonnè 1P



### Pag. 96

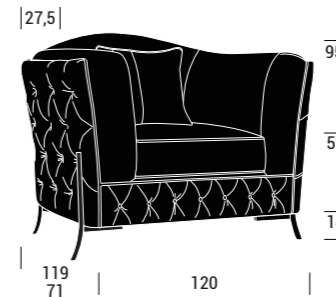

Rivestimento /  
Upholstery /  
Обивочная ткань  
● Vegas Velvet Plain  
1403/83  
● Old/1



Lavorazione schienale interno liscio  
Lavorazione scocca esterna capitonnè  
Plain inside backrest version  
Capitonè outer shell version  
Внутренняя обивка спинки - гладкая  
Внешняя обивка каркаса - каретная  
стяжка ("капитоне")



P 64 Piede in metallo  
ottonato lucido  
Polished brass-plated  
metal legs  
Ножка – металл в  
отделке блестящая  
латунь

### Nefele decor

cuscini inclusi / included throw pillows /  
в комплекте с подушками



● – 45X45

1x

### Nefele luxury

cuscini inclusi / included throw pillows /  
в комплекте с подушками



● – 45X45

1x

La **versione decor** include  
cuscini decorativi in diversi  
colori come foto pag. 96.  
La **versione luxury** include  
cuscini monocromatici  
rivestiti con il medesimo  
tessuto/pelle del divano.

The **decor version** includes  
throw pillows made of decorative  
fabrics, as on page 96.  
The **luxury version** includes solid  
colour throw pillows upholstered  
with the same fabric/leather  
used for the sofa.

**Версия decor** включает  
подушки разного цвета как  
на фотографии стр. 96.  
**Версия luxury** включает  
однотонные подушки,  
обитые тканью/кожей  
того же цвета, что и диван.

### Nefele capitonnè 1P



### Pag. 110

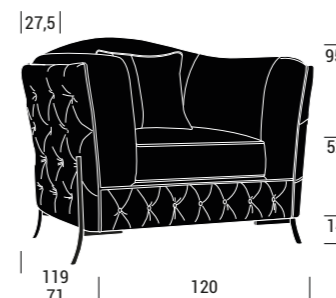

Rivestimento /  
Upholstery /  
Обивочная ткань  
● -8336/51  
● -8336/60  
● -Java Dove  
F0496/10

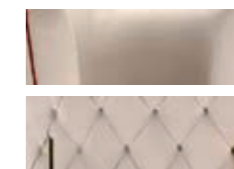

Lavorazione schienale interno liscio  
Lavorazione scocca esterna  
capitonè  
Plain inside backrest version  
Capitonè outer shell version  
Внутренняя обивка спинки -  
гладкая  
Внешняя обивка каркаса -  
каретная стяжка ("капитоне")



P 64 Piede in metallo  
ottonato lucido  
Polished brass-plated  
metal legs  
Ножка – металл в  
отделке блестящая  
латунь

### Nefele decor

cuscini inclusi / included throw pillows /  
в комплекте с подушками



● – 45X45

1x

### Nefele luxury

cuscini inclusi / included throw pillows /  
в комплекте с подушками



● – 45X45

1x

La **versione decor** include  
cuscini decorativi in diversi  
colori come foto pag. 110.  
La **versione luxury** include  
cuscini monocromatici  
rivestiti con il medesimo  
tessuto/pelle del divano.

The **decor version** includes  
throw pillows made of decorative  
fabrics, as on page 110.  
The **luxury version** includes solid  
colour throw pillows upholstered  
with the same fabric/leather  
used for the sofa.

**Версия decor** включает  
подушки разного цвета как  
на фотографии стр. 110.  
**Версия luxury** включает  
однотонные подушки,  
обитые тканью/кожей  
того же цвета, что и диван.

### Nefele plain 1P



### Pag. 110

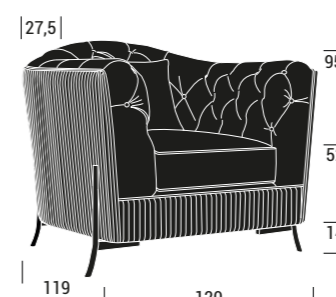

Rivestimento /  
Upholstery /  
Обивочная ткань  
● -8336/60  
● -Java Heather  
F0496/20  
● -Art.1469/60  
trapuntato quilted  
с прошивкой

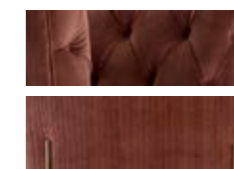

Lavorazione schienale  
interno capitonnè. Lavorazione  
scocca esterna liscia.  
Capitonè backrest  
Plain outer shell version  
Внутренняя обивка  
спинки - "капитоне"  
Внутренняя обивка  
спинки - гладкая

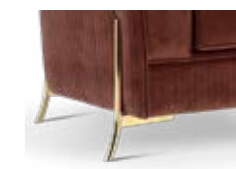

P 64 Piede in metallo  
ottonato lucido  
Polished brass-plated  
metal legs  
Ножка – металл в  
отделке блестящая  
латунь

### Nefele decor

cuscini inclusi / included throw pillows /  
в комплекте с подушками



● – 45X45

1x

### Nefele luxury

cuscini inclusi / included throw pillows /  
в комплекте с подушками



● – 45X45

1x

La **versione decor** include  
cuscini decorativi in diversi  
colori come foto pag. 110.  
La **versione luxury** include  
cuscini monocromatici  
rivestiti con il medesimo  
tessuto/pelle del divano.

The **decor version** includes  
throw pillows made of decorative  
fabrics, as on page 110.  
The **luxury version** includes solid  
colour throw pillows upholstered  
with the same fabric/leather  
used for the sofa.

**Версия decor** включает  
подушки разного цвета как  
на фотографии стр. 110.  
**Версия luxury** включает  
однотонные подушки,  
обитые тканью/кожей  
того же цвета, что и диван.

### Divani Sofas Диваны

Domingo—Luxury

### Nefele

**Nefele Plain 3P** Pag. 102

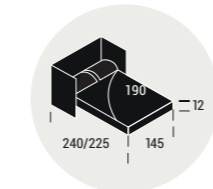
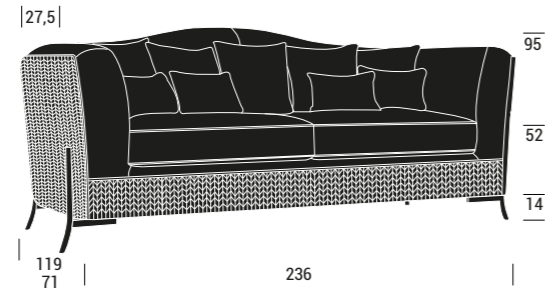

**Nefele decor** cuscini inclusi / included throw pillows / в комплекте с подушками



1 - 45X45 2x 2 - 45X45 2x 3 - 45X45 1x 4 - 35X25 2x 5 - 35X25 2x

**Rivestimento / Upholstery / Обивочная ткань**  
 1 - 8336/55  
 2 - Java Eau de Nil F0496/14  
 3 - Java Dove F0496/10  
 4 - Maui Slate F1302/05  
 5 - Art.1456/55 trapuntato quilted с прошивкой

Lavorazione schienale interno capitonné  
 Lavorazione scocca esterna liscia  
 Capitonné backrest Plain outer shell version  
 Внутренняя обивка спинки - "капитоне"  
 Внутренняя обивка спинки - гладкая

**Nefele luxury** cuscini inclusi / included throw pillows / в комплекте с подушками

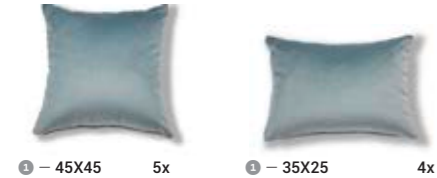

1 - 45X45 5x 2 - 35X25 4x

La **versione decor** include cuscini decorativi in diversi colori come foto pag. 102. La **versione luxury** include cuscini monocromatici rivestiti con il medesimo tessuto/pelle del divano.

The **decor version** includes throw pillows made of decorative fabrics, as on page 102. The **luxury version** includes solid colour throw pillows upholstered with the same fabric/leather used for the sofa.

**Версия decor** включает подушки разного цвета как на фотографии стр. 102. **Версия luxury** включает однотонные подушки, обитые тканью/кожей того же цвета, что и диван.



P 64 Piede in metallo ottonato lucido  
 Polished brass-plated metal legs  
 Ножка - металл в отделке блестящая латунь

**Nefele capitonné 3P** Pag. 96

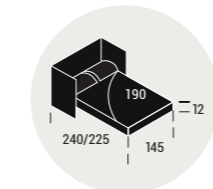
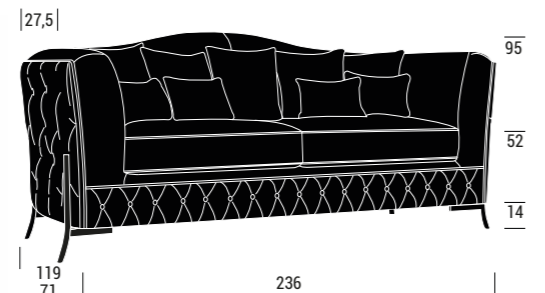

**Nefele decor** cuscini inclusi / included throw pillows / в комплекте с подушками

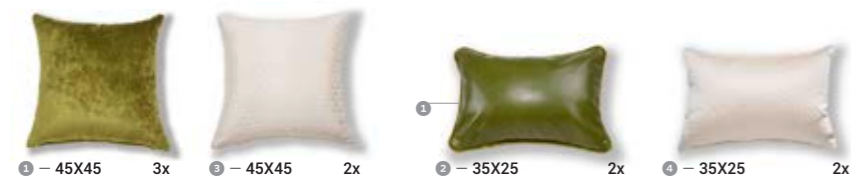

1 - 45X45 3x 2 - 45X45 2x 3 - 35X25 2x 4 - 35X25 2x

**Rivestimento / Upholstery / Обивочная ткань**  
 1 - Vegas Velvet Plain 1403/67  
 2 - Old/1  
 3 - Diamond Luxury/01  
 4 - Mirage Luxury/01

Lavorazione schienale interno liscio  
 Lavorazione scocca esterna capitonné  
 Plain inside backrest version  
 Capitonné outer shell version  
 Внутренняя обивка спинки - гладкая  
 Внешняя обивка каркаса - каретная стяжка ("капитоне")

**Nefele luxury** cuscini inclusi / included throw pillows / в комплекте с подушками

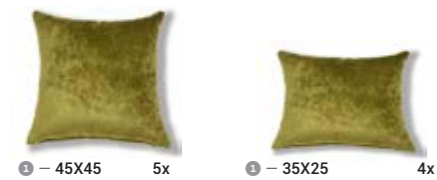

1 - 45X45 5x 2 - 35X25 4x

La **versione decor** include cuscini decorativi in diversi colori come foto pag. 96. La **versione luxury** include cuscini monocromatici rivestiti con il medesimo tessuto/pelle del divano.

The **decor version** includes throw pillows made of decorative fabrics, as on page 96. The **luxury version** includes solid colour throw pillows upholstered with the same fabric/leather used for the sofa.

**Версия decor** включает подушки разного цвета как на фотографии стр. 96. **Версия luxury** включает однотонные подушки, обитые тканью/кожей того же цвета, что и диван.



P 64 Piede in metallo ottonato lucido  
 Polished brass-plated metal legs  
 Ножка - металл в отделке блестящая латунь

**Nefele Plain 4P** Pag. 106

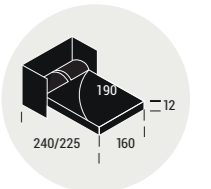
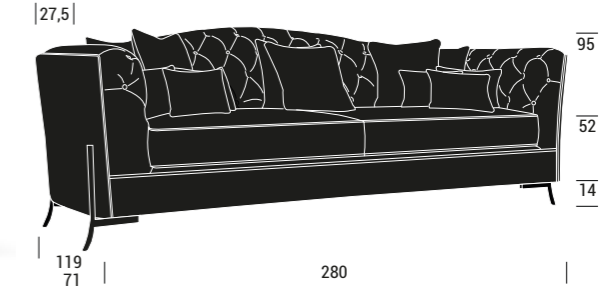

**Nefele decor** cuscini inclusi / included throw pillows / в комплекте с подушками



1 - 45X45 3x 2 - 45X45 3x 3 - 35X25 2x 4 - 35X25 4x

**Rivestimento / Upholstery / Обивочная ткань**  
 1 - G075/312  
 2 - Moon/619 Giallino  
 3 - Jungle Velvet 1638/05  
 4 - Candide/3200 12 67

Lavorazione schienale interno capitonné  
 Lavorazione scocca esterna liscia  
 Capitonné backrest Plain outer shell version  
 Внутренняя отделка спинки - "капитоне"  
 Внутренняя обивка спинки - гладкая

**Nefele luxury** cuscini inclusi / included throw pillows / в комплекте с подушками

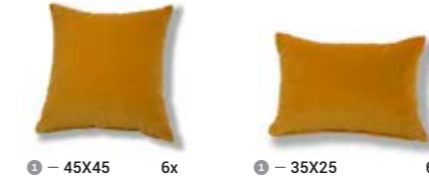

1 - 45X45 6x 2 - 35X25 6x

La **versione decor** include cuscini decorativi in diversi colori come foto pag. 106. La **versione luxury** include cuscini monocromatici rivestiti con il medesimo tessuto/pelle del divano.

The **decor version** includes throw pillows made of decorative fabrics, as on page 106. The **luxury version** includes solid colour throw pillows upholstered with the same fabric/leather used for the sofa.

**Версия decor** включает подушки разного цвета как на фотографии стр. 106. **Версия luxury** включает однотонные подушки, обитые тканью/кожей того же цвета, что и диван.



P 64 Piede in metallo ottonato lucido  
 Polished brass-plated metal legs  
 Ножка - металл в отделке блестящая латунь



Рouf  
Рoufs  
Щуффы

119

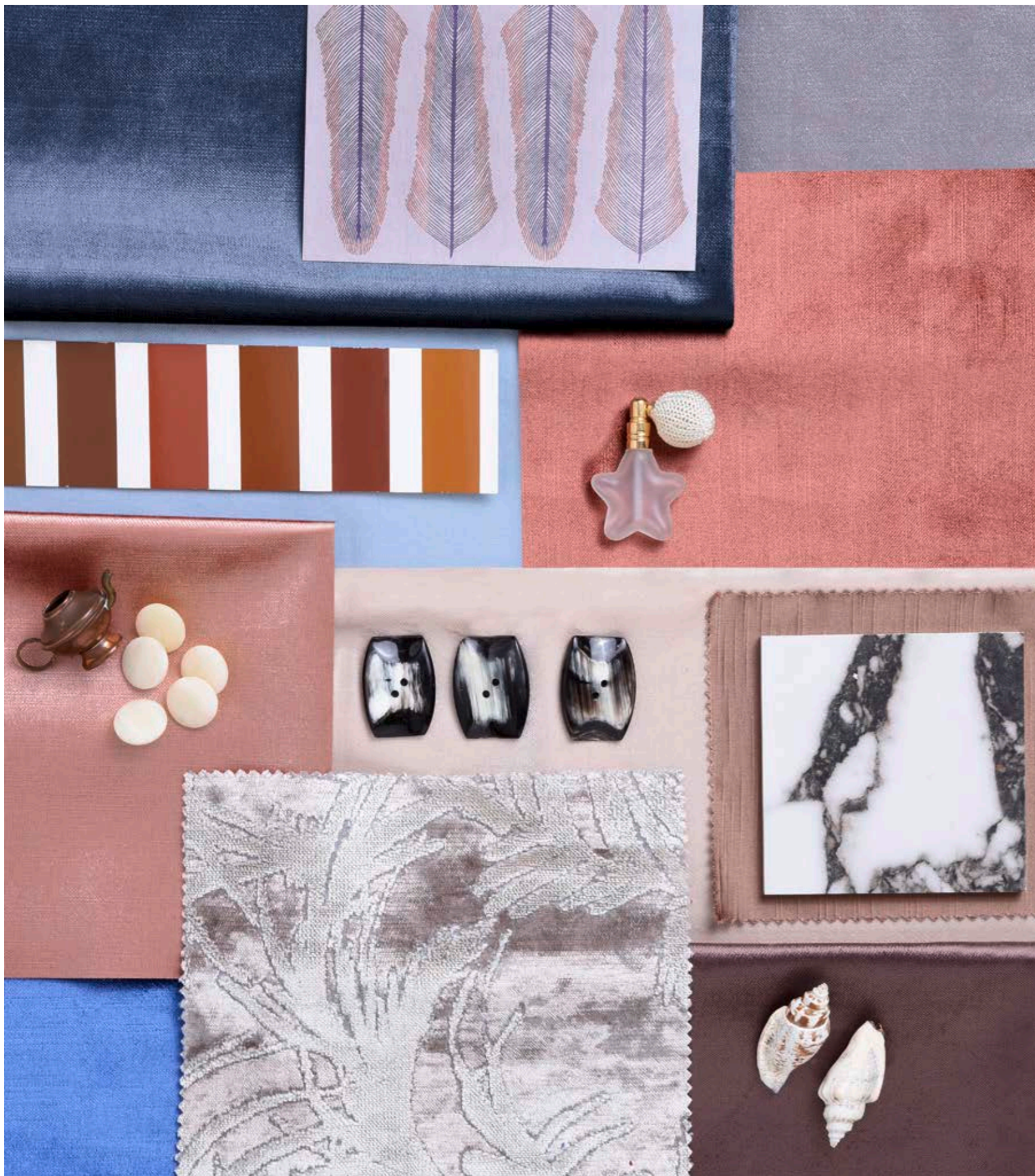

Un fiore grazioso, morbido, delicato e ricco di personalità, che spunta inaspettatamente in un giardino incantato con il preciso intento di riempirlo di grazia. Il pouf Arke è ispirato alla dea dell'arcobaleno, messaggera dei Titani.

A soft, delicate flower full of personality that unexpectedly sprouts in an enchanted garden with the precise intention of filling it with grace. The Arke pouf is inspired by the rainbow goddess, messenger of the Titans.

Изящный, мягкий, нежный и полный индивидуальности цветок, неожиданно появившийся в волшебном саду с явным намерением наполнить его грацией. Пуф Арке был вдохновлен богиней радуги, посланницей Титанов.



# Arke





**Pouf Poufs Пуфы**  
Domingo—Luxury

Arke





POUF
POUF
ПУФ
<b>Sm D50xh40</b>
<b>Md D70xh40</b>
<b>Lg D100xh40</b>
<b>Bc 135x50xh40</b>

**Finiture laminato / Laminate finishings /  
Ламинированный деревянный цоколь**



Palette laminati  
a pag. 202  
Page 202 laminated  
frame palette  
Палитра отделок  
ламината на стр. 202



# Arke

Struttura in multistrato di abete in vari spessori, cl. E1 a bassa emissione di formaldeide. Imbottitura in poliuretano espanso indeformabile in densità da 30 a 40 kg/m<sup>3</sup> e ovatta in poliester. Base in legno laminato in vari colori. Resine e collanti utilizzati sono privi di sostanze ozonolesive, CFC e solventi clorurati. Tutti i materiali impiegati rispettano la normativa EU 91/156 per lo smaltimento dei rifiuti. Prodotto lavorato interamente a mano in Italia. Il pouf Arke può essere rivestito con tutti i tessuti e le pelli delle collezioni tessili Domingo.

E1 fir plywood frame featuring low formaldehyde emission. 30 to 40 kg/m<sup>3</sup> non-deformable polyurethane foam padding and polyester wadding. Laminated wood base (various colours available). The resins and adhesives we use are free of ozone-depleting substances, CFCs and chlorinated solvents. All the materials we use are in compliance with EU 91/156 regulations on waste disposal. Entirely handmade in Italy. The Arke pouf can be upholstered with any fabrics or leathers from the Domingo textile collections.

Структура - многослойная фанера из ели разной толщины класса E1 с низкой эмиссией формальдегида. Внутреннее наполнение - недеформируемый пенополиуретан плотностью от 30 до 40 кг/м<sup>3</sup> и синтепон. Ламинированный деревянный цоколь может быть выполнен в различных цветах. Используемые типы смол и клеящих материалов не содержат озоноразрушающих веществ, хлорфторуглеродов и хлорсодержащих растворителей. Все материалы соответствуют требованиям EU 91/156 по утилизации отходов. Изделия ручной работы, полностью произведенные в Италии. Обивка пуфа Arke может быть выполнена из всех видов ткани и кожи коллекции Domingo.

## Arke Sm

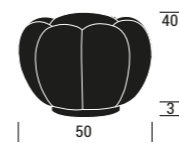

**Rivestimento / Upholstery / Обивочная ткань**  
①-Brooklyn/07



Base in laminato 2007 vg CT  
Laminate base 2007 vg CT  
Цоколь: ламинат 2007 vg CT



**Rivestimento / Upholstery / Обивочная ткань**  
①-Brooklyn/46



Base in laminato 2006 vg LUC  
Laminate base 2006 vg LUC  
Цоколь: ламинат 2006 vg LUC

## Arke Md

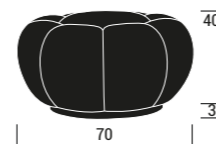

**Rivestimento / Upholstery / Обивочная ткань**  
①-Brooklyn/41



Base in laminato 2006 vg LUC  
Laminate base 2006 vg LUC  
Цоколь: ламинат 2006 vg LUC



**Rivestimento / Upholstery / Обивочная ткань**  
①-Brooklyn/13



Base in laminato 2007 vg CT  
Laminate base 2007 vg CT  
Цоколь: ламинат 2007 vg CT

## Arke Lg

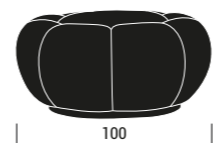

**Rivestimento / Upholstery / Обивочная ткань**  
①-Brooklyn/24

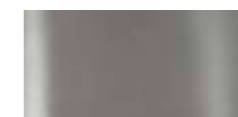

Base in laminato 2007 vg CT  
Laminate base 2007 vg CT  
Цоколь: ламинат 2007 vg CT



**Rivestimento / Upholstery / Обивочная ткань**  
①-Brooklyn/23



Base in laminato 2006 vg LUC  
Laminate base 2006 vg LUC  
Цоколь: ламинат 2006 vg LUC

## Arke Bc

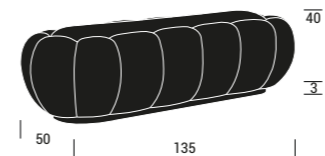

**Rivestimento / Upholstery / Обивочная ткань**  
①-Brooklyn/20



Base in laminato 2008 vg SAT  
Laminate base 2008 vg SAT  
Цоколь: ламинат 2008 vg SAT



**Rivestimento / Upholstery / Обивочная ткань**  
①-Brooklyn/33



Base in laminato 2000 vg SAT  
Laminate base 2000 vg SAT  
Цоколь: ламинат 2000 vg SAT

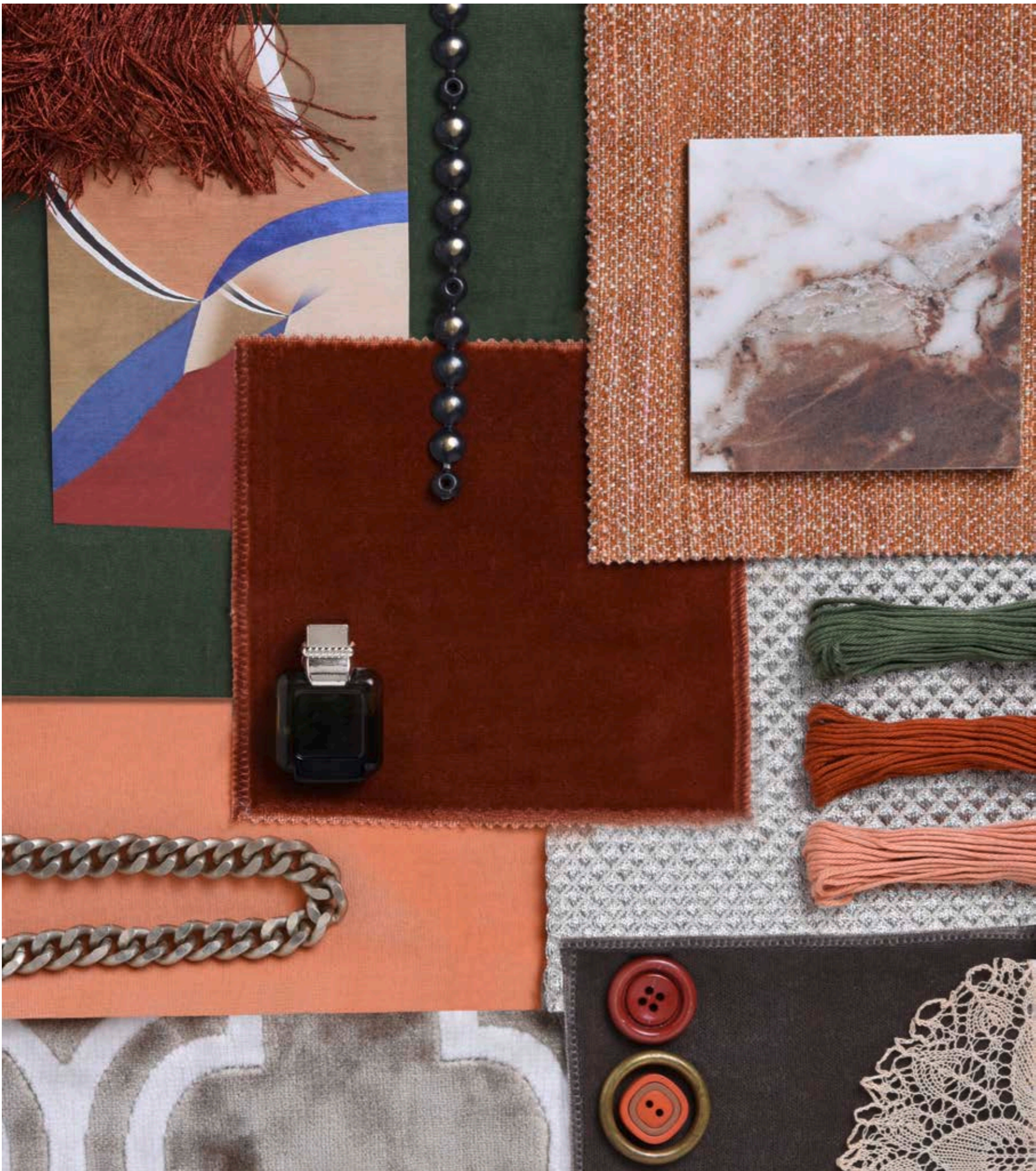

I pouf e le panchette Dione abbinati ai divani e alle poltrone dell'omonima collezione ispirata alla dea dell'amore, dell'acqua e del cielo luminoso, impreziosiscono l'ambiente connotandolo di una ricchezza semplice e irrinunciabile.

The Dione poufs and benches, combined with sofas and armchairs of the homonymous series inspired by the goddess of love, water and clear skies, embellish any living space with a simple and indispensable richness.

Пуфы и банкетки Dione в сочетании с диванами и креслами одноименной коллекции, вдохновленной богиней любви, дождя и ясного неба, украшают и обогащают интерьеры простым и незаменимым образом.



# Dione





**Pouf Poufs Пуфы**  
Domingo—Luxury

**Dione**

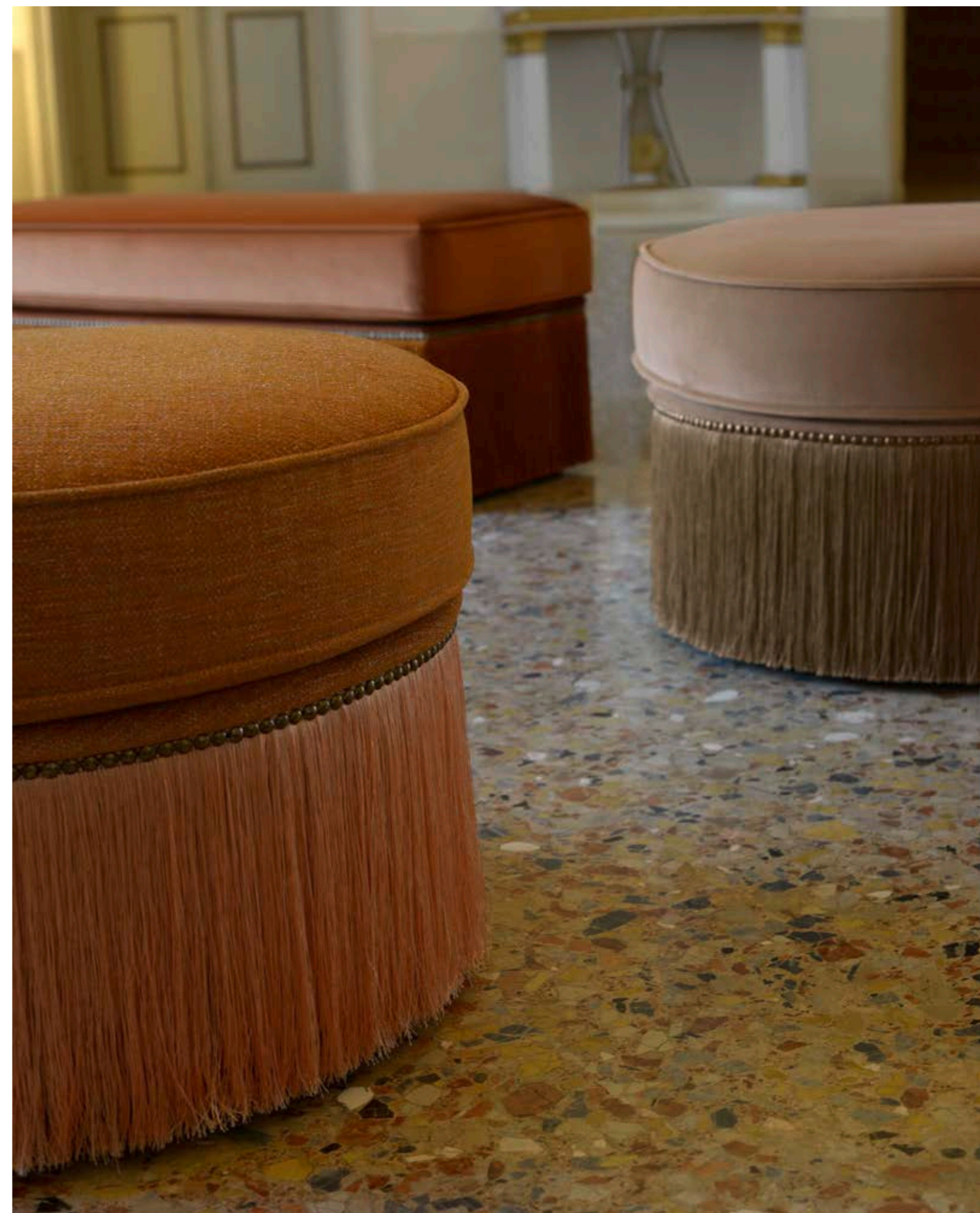

POUF  
POUF  
ПУФ

**Sm D50xh45**

**Md D70xh45**

**Bc 120x45xh45**

# Dione

Struttura in multistrato di abete in vari spessori, cl. E1 a bassa emissione di formaldeide. Imbottitura in poliuretano espanso indeformabile in densità da 30 a 40 kg/m<sup>3</sup> e ovatta in poliestere. Frangia in filato di organzino. Resine e collanti utilizzati sono privi di sostanze ozonolesive, CFC e solventi clorurati. Tutti i materiali impiegati rispettano la normativa EU 91/156 per lo smaltimento dei rifiuti. Prodotto lavorato interamente a mano in Italia. Il pouf Dione può essere rivestito con tutti i tessuti e le pelli delle collezioni tessili Domingo.

E1 fir plywood frame featuring low formaldehyde emission. 30 to 40 kg/m<sup>3</sup> non-deformable polyurethane foam padding and polyester wadding. Organzine yarn fringe. The resins and adhesives we use are free of ozone-depleting substances, CFCs and chlorinated solvents. All the materials we use are in compliance with EU 91/156 regulations on waste disposal. Entirely handmade in Italy. The Dione pouf can be upholstered with any fabrics or leathers from the Domingo textile collections.

Структура - многослойная фанера из ели разной толщины класса E1 с низкой эмиссией формальдегида. Внутреннее наполнение - недеформируемый пенополиуретан плотностью от 30 до 40 кг/м<sup>3</sup> и синтепон. Бахрома - шелковая глянцевая пряжа. Используемые типы смол и клеящих материалов не содержат озоноразрушающих веществ, хлорфторуглеродов и хлорсодержащих растворителей. Все материалы соответствуют требованиям EU 91/156 по утилизации отходов. Изделия ручной работы, полностью произведенные в Италии. Обивка пуфа Dione может быть выполнена из всех видов ткани и кожи коллекции Domingo.

## Dione Sm pouf

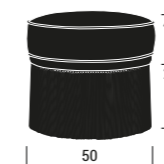

**Rivestimento / Upholstery / Обивочная ткань**  
①-G075/102  
②-Frangia fringe Бахрома h26/72R STD  
Chiodini in oro invecchiato  
Aged golden nails  
Заклепки под состарившееся золото



**Rivestimento / Upholstery / Обивочная ткань**  
①-G075/102  
②-Frangia fringe Бахрома h26/29R STD  
Chiodini in oro invecchiato  
Aged golden nails  
Заклепки под состарившееся золото

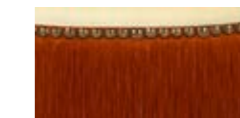

## Dione Md pouf

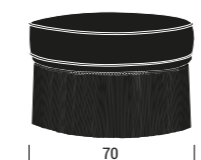

**Rivestimento / Upholstery / Обивочная ткань**  
①-G075/208  
②-Frangia fringe Бахромаh26/254R STD  
Chiodini in oro invecchiato  
Aged golden nails  
Заклепки под состарившееся золото



**Rivestimento / Upholstery / Обивочная ткань**  
①-80723 Crusca/46 Rame rosato  
②-Frangia fringe Бахрома h26/79R OPT  
Chiodini in oro invecchiato  
Aged golden nails  
Заклепки под состарившееся золото



## Dione Bc bench

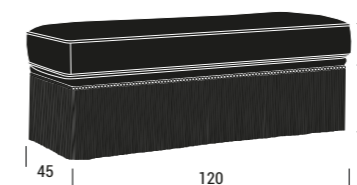

**Rivestimento / Upholstery / Обивочная ткань**  
①-G075/456  
②-Frangia fringe Бахрома h26/79R OPT  
Chiodini in oro invecchiato  
Aged golden nails  
Заклепки под состарившееся золото



**Rivestimento / Upholstery / Обивочная ткань**  
①-8336/15  
②-Frangia fringe Бахрома h26/29R STD  
Chiodini in oro invecchiato  
Aged golden nails  
Заклепки под состарившееся золото



Frangia / Fringe / Бахрома / h26 cm

STD = colori di serie / standard colours / стандартные цвета  
 OPT = colori optional / optional colours / по желанию  
 (за дополнительную оплату)

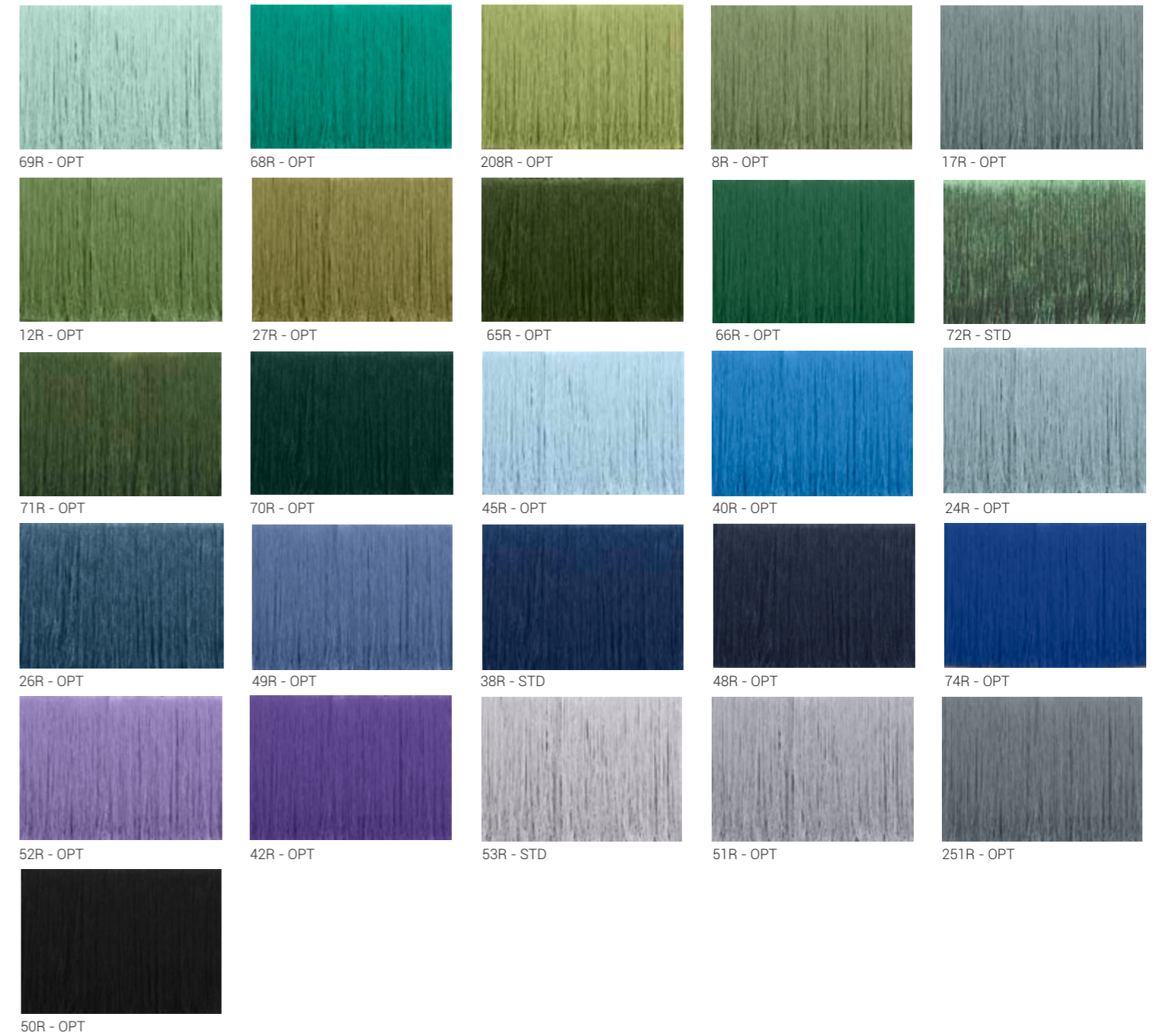

Chiodini metallici / Metal nails / Металлические заклепки





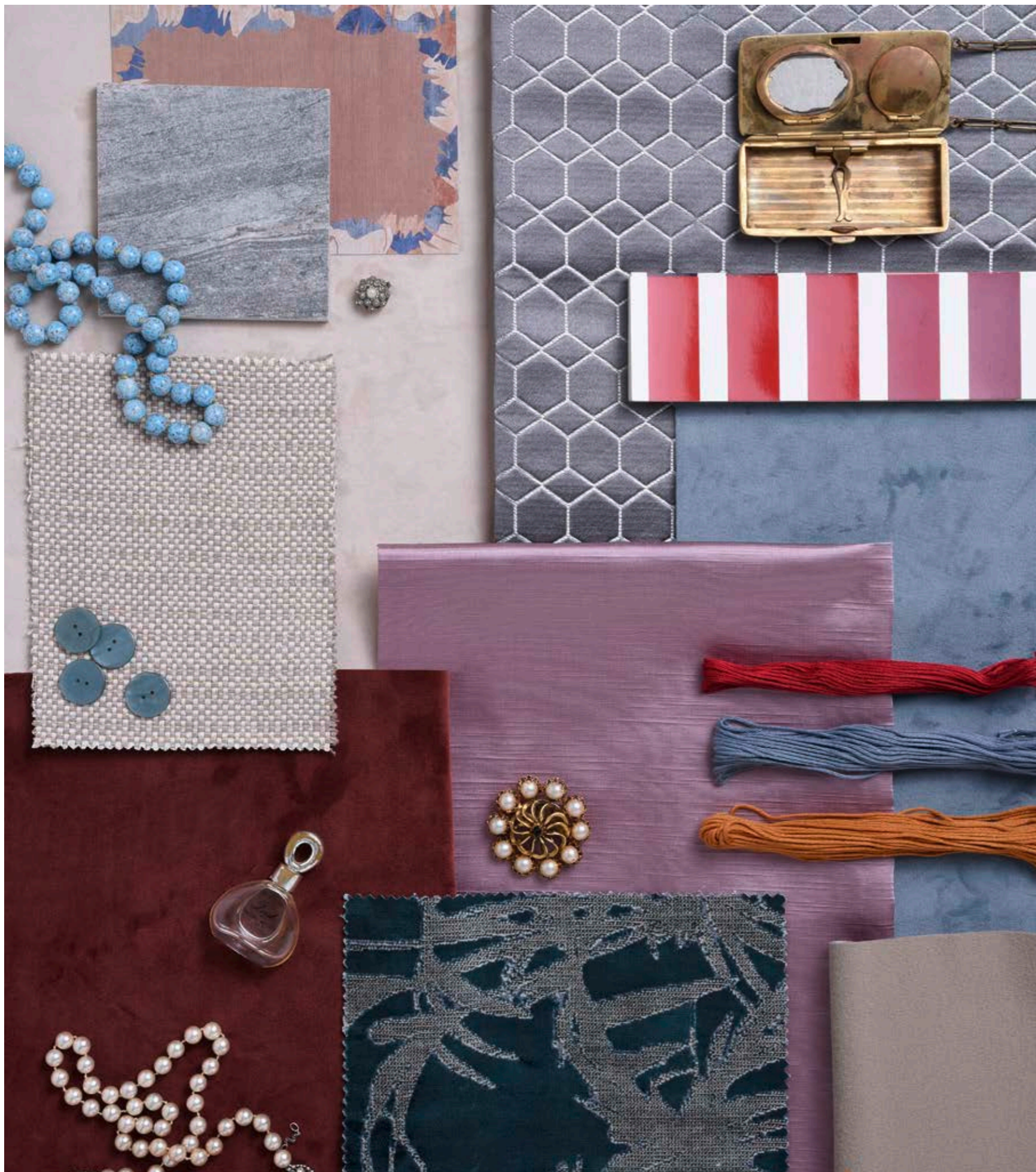

Geometrie primarie e rigore formale Eos, una linea di pouf che completano l'ambiente con spirito minimalista, ispirati alla divinità dell'alba, la dea dalle "rose dita" citata da Omero.

Primary geometries and formal rigor for Eos, a series of poufs that complete the spaces they occupy with a minimalist spirit, inspired by the rosy-fingered goddess of dawn mentioned by Homer.

Основные геометрические формы и формальная строгость для пуфов Eos, которые дополняют оформление интерьера в минималистском стиле и относят нас к богине утренней зари, упоминаемой Гомером как богиня с «розовыми перстами».



# Eos





**Pouf Poufs Пуфы**  
Domingo—Luxury

Eos

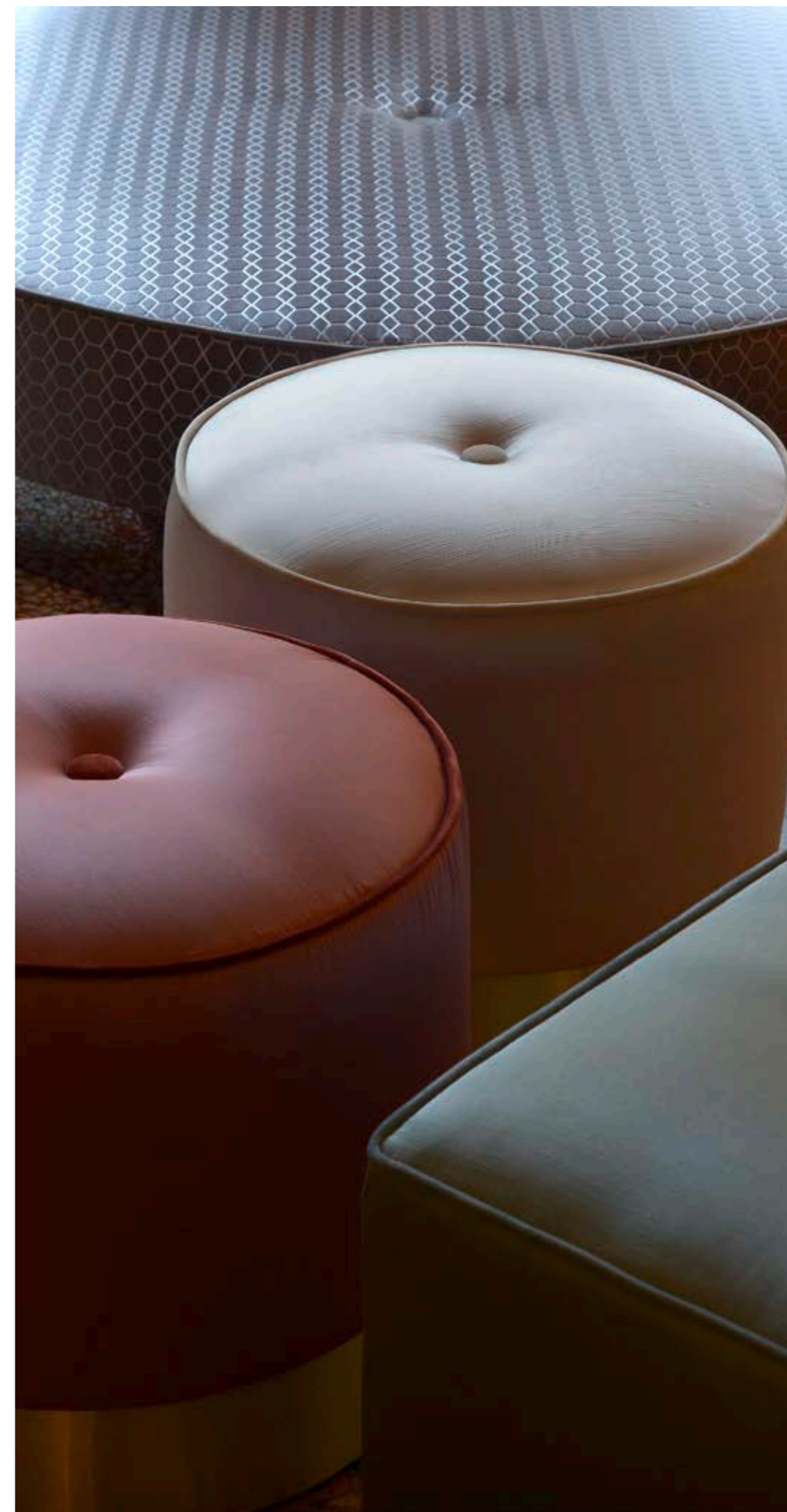

POUF
POUF
ПУФ
<b>Rs D45xh42</b>
<b>Sm 45x45xh42</b>
<b>Rb D120xh30</b>

**Finiture laminato / Laminate finishings /  
Ламинированный деревянный цоколь**



Palette laminati  
a pag. 202  
Page 202 laminated  
frame palette  
Палитра отделок  
ламината на стр. 202



# Eos

Struttura in multistrato di abete in vari spessori, cl. E1 a bassa emissione di formaldeide. Imbottitura in poliuretano espanso indeformabile in densità da 30 a 40 kg/m<sup>3</sup> e ovatta in poliestere. Base in legno laminato in vari colori. Resine e collanti utilizzati sono privi di sostanze ozonolesive, CFC e solventi clorurati. Tutti i materiali impiegati rispettano la normativa EU 91/156 per lo smaltimento dei rifiuti. Prodotto lavorato interamente a mano in Italia. Il pouf Eos può essere rivestito con tutti i tessuti e le pelli delle collezioni tessili Domingo.

E1 fir plywood frame (thickness varies) featuring low formaldehyde emission. 30 to 40 kg/m<sup>3</sup> non-deformable polyurethane foam padding and polyester wadding. Laminated wood base (various colours available). The resins and adhesives we use are free of ozone-depleting substances, CFCs and chlorinated solvents. All the materials we use are in compliance with EU 91/156 regulations on waste disposal. Entirely handmade in Italy. The Eos pouf can be upholstered with any fabrics or leathers from the Domingo textile collections.

Структура - многослойная фанера из ели разной толщины класса E1 с низкой эмиссией формальдегида. Внутреннее наполнение - недеформируемый пенополиуретан плотностью от 30 до 40 кг/м<sup>3</sup> и синтепон. Ламинированный деревянный цоколь может быть выполнен в различных цветах. Используемые типы смол и клеящих материалов не содержат озоноразрушающих веществ, хлорфторуглеродов и хлорсодержащих растворителей. Все материалы соответствуют требованиям EU 91/156 по утилизации отходов. Изделия ручной работы, полностью произведенные в Италии. Обивка пуфа Eos может быть выполнена из всех видов ткани и кожи коллекции Domingo.

## Eos Rs

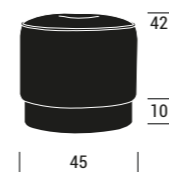

## Eos Sm

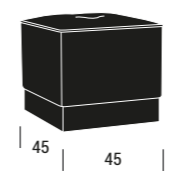

## Eos Rb

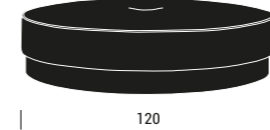

**Rivestimento / Upholstery / Обивочная ткань**  
 ①-Java Heather F0496/20  
 ②-Bottone e filetto 8336/6  
 Button and piping 8336/6  
 Пуговица и кант: 8336/6



Base in laminato 2003 vg SAT  
 Laminate base 2003 vg SAT  
 Цоколь: ламинат 2003 vg SAT



**Rivestimento / Upholstery / Обивочная ткань**  
 ①-Java Dove F0496/10  
 ②-Bottone e filetto 8336/51  
 Button and piping 8336/51  
 Пуговица и кант: 8336/51



Base in laminato 2003 vg SAT  
 Laminate base 2003 vg SAT  
 Цоколь: ламинат 2003 vg SAT



**Rivestimento / Upholstery / Обивочная ткань**  
 ①-Kauai Mocha F1299/07  
 ②-Bottone 8336/51  
 Button 8336/51  
 Пуговица: 8336/51



Base in laminato 2003 vg SAT  
 Laminate base 2003 vg SAT  
 Цоколь: ламинат 2003 vg SAT

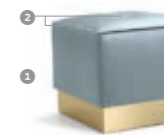

**Rivestimento / Upholstery / Обивочная ткань**  
 ①-Java Eau de Nil F0496/14  
 ②-Bottone e filetto 8336/55  
 Button and piping 8336/55  
 Пуговица и кант: 8336/55



Base in laminato 2003 vg SAT  
 Laminate base 2003 vg SAT  
 Цоколь: ламинат 2003 vg SAT



**Rivestimento / Upholstery / Обивочная ткань**  
 ①-Candide/3200 12 67  
 ②-Bottone e filetto 8336/5  
 Button and piping 8336/5  
 Пуговица и кант 8336/5



Base in laminato 2007 vg CT  
 Laminate base 2007 vg CT  
 Цоколь: ламинат 2007 vg CT

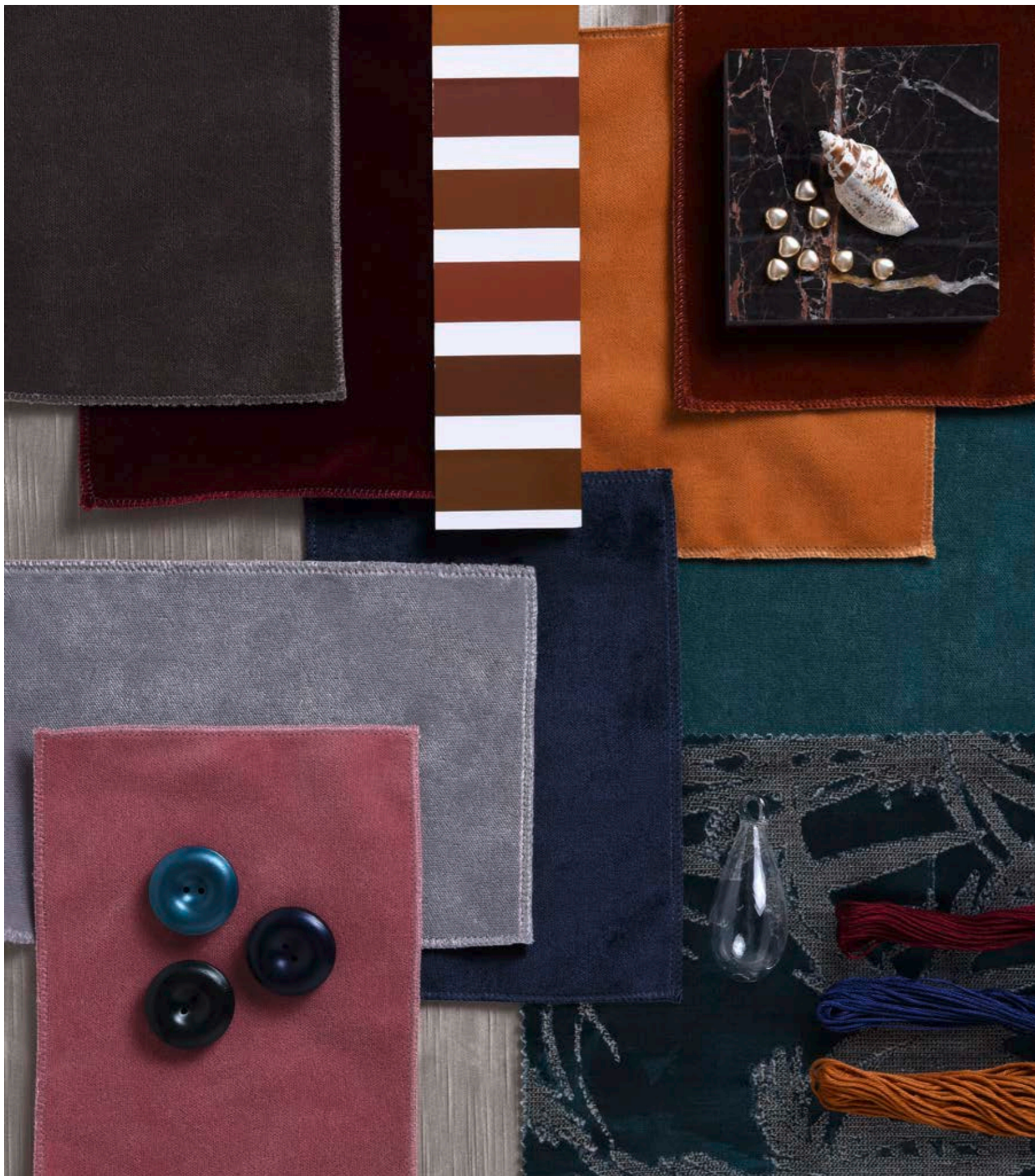

Semplice, elegante e cromaticamente mutevole, il pouf Chione, ispirato alla dea della bellezza, si inserisce silenzioso in qualsiasi ambiente alla ricerca di elementi complementari ma non invadenti.

Understated, elegant and chromatically changeable, the Chione pouf is inspired by the goddess of beauty, and fits quietly wherever complementary but non intrusive elements are needed.

Простой, элегантный и "цветоизменяемый" пуф Chione, посвященный богине красоты - Хионе, бесшумно вписывается в любой интерьер в поисках комплектующих ненавязчивых элементов.



# Chione





**Pouf Poufs Пуфы**  
Domingo—Luxury

**Chione**





POUF  
POUF  
ПУФ

D40xh44

**Finiture laminato / Laminate finishings /  
Ламинированный деревянный цоколь**



Palette laminati  
a pag. 202  
Page 202 laminated  
frame palette  
Палитра отделки  
ламината на стр. 202



# Chione

Struttura in multistrato di abete in vari spessori, cl. E1 a bassa emissione di formaldeide. Imbottitura in poliuretano espanso indeformabile in densità da 30 a 40 kg/m<sup>3</sup> e ovatta in poliester. Base in legno laminato in vari colori. Resine e collanti utilizzati sono privi di sostanze ozonolesive, CFC e solventi clorurati. Tutti i materiali impiegati rispettano la normativa EU 91/156 per lo smaltimento dei rifiuti. Prodotto lavorato interamente a mano in Italia. Il pouf Chione può essere rivestito con tutti i tessuti e le pelli delle collezioni tessili Domingo.

E1 fir plywood frame (thickness varies) featuring low formaldehyde emission. 30 to 40 kg/m<sup>3</sup> non-deformable polyurethane foam padding and polyester wadding. Laminated wood base (various colours available). The resins and adhesives we use are free of ozone-depleting substances, CFCs and chlorinated solvents. All the materials we use are in compliance with EU 91/156 regulations on waste disposal. Entirely handmade in Italy. The Chione pouf can be upholstered with any fabrics or leathers from the Domingo textile collections.

Структура - многослойная фанера из ели разной толщины класса E1 с низкой эмиссией формальдегида. Внутреннее наполнение - недеформируемый пенополиуретан плотностью от 30 до 40 кг/м<sup>3</sup> и синтепон. Ламинированный деревянный цоколь может быть выполнен в различных цветах. Используемые типы смол и клеящих материалов не содержат озоноразрушающих веществ, хлорфторуглеродов и хлорсодержащих растворителей. Все материалы соответствуют требованиям EU 91/156 по утилизации отходов. Изделия ручной работы, полностью произведенные в Италии. Обивка пуфа Chione может быть выполнена из всех видов ткани и кожи коллекции Domingo.

## Chione

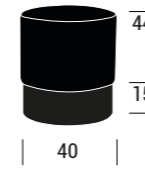

40

<p>Rivestimento / Upholstery / Обивочная ткань ①-8336/11</p>	<p>Rivestimento / Upholstery / Обивочная ткань ①-8336/5</p>
<p>Rivestimento / Upholstery / Обивочная ткань ①-8336/15</p>	<p>Rivestimento / Upholstery / Обивочная ткань ①-8336/57</p>
<p>Rivestimento / Upholstery / Обивочная ткань ①-8336/40</p>	<p>Rivestimento / Upholstery / Обивочная ткань ①-8336/57</p>
<p>Rivestimento / Upholstery / Обивочная ткань ①-8336/29</p>	<p>Rivestimento / Upholstery / Обивочная ткань ①-8336/3</p>
<p>Rivestimento / Upholstery / Обивочная ткань ①-8336/5</p>	<p>Rivestimento / Upholstery / Обивочная ткань ①-8336/53</p>
<p>Rivestimento / Upholstery / Обивочная ткань ①-8336/15</p>	<p>Rivestimento / Upholstery / Обивочная ткань ①-8336/27</p>
<p>Rivestimento / Upholstery / Обивочная ткань ①-8336/5</p>	<p>Rivestimento / Upholstery / Обивочная ткань ①-8336/40</p>



Sofisticato, morbido ed  
ammiccante, il pouf Tara trae  
ispirazione dalle Esperidi, le  
ninfe della sera e della luce del  
tramonto.

Sophisticated, soft and  
allusive, the Tara pouf  
draws inspiration from  
the Hesperides, the nymphs  
of the evening and of the  
golden light of sunsets.

Изысканный, мягкий  
и привлекательный  
пуф Tara воплощает  
Гесперид - нимф заката и  
заходящего солнца.



# Tara





**Pouf Poufs Пуфы**  
Domingo—Luxury

Tara

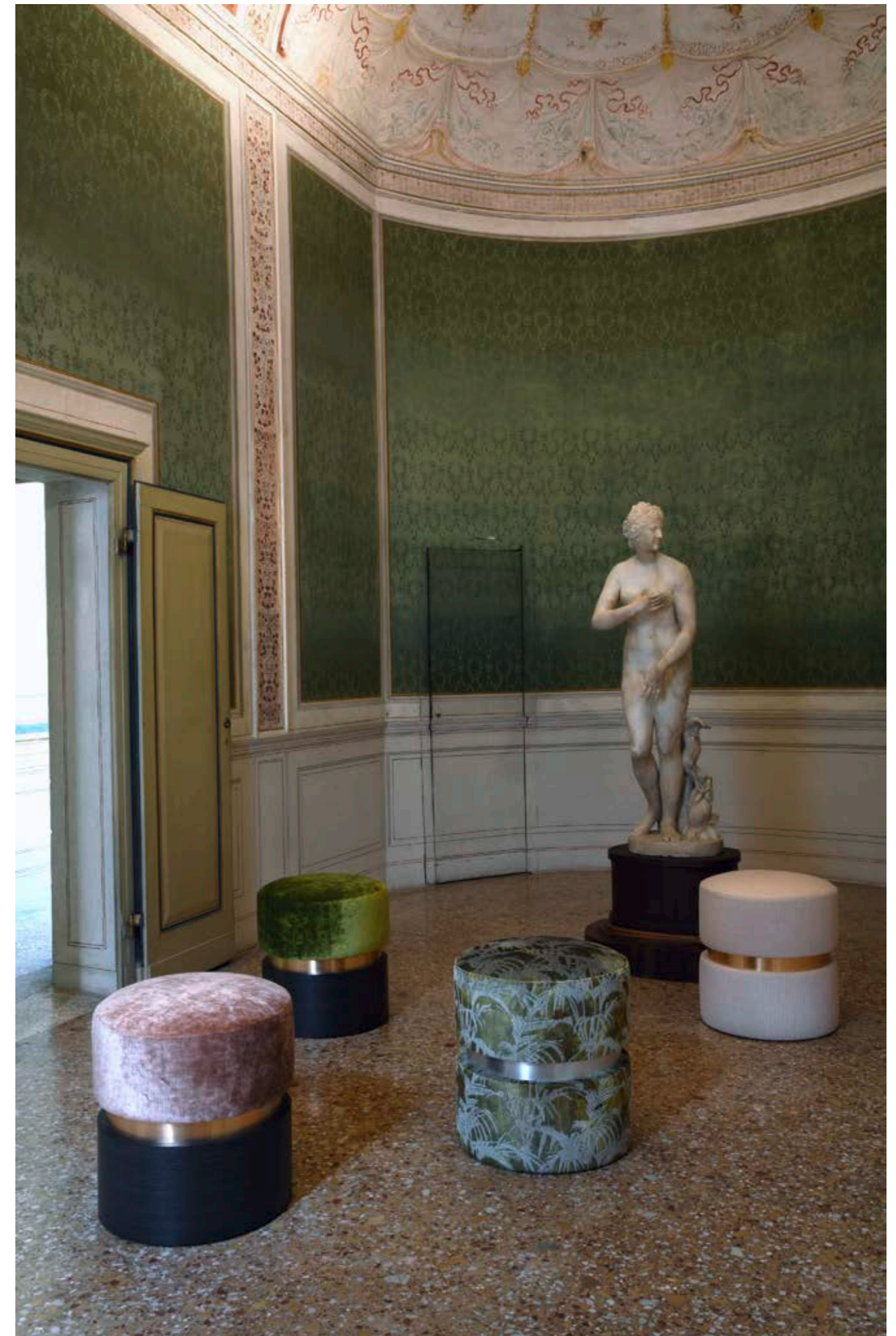

POUF  
POUF  
ПУФ

D50xh45

### Finiture laminato / Laminate finishings / Ламинированный деревянный цоколь



Palette laminati  
a pag. 202  
Page 202 laminated  
frame palette  
Палитра отделки  
ламината на стр. 202



# Tara

Struttura in multistrato di abete in vari spessori, cl. E1 a bassa emissione di formaldeide. Imbottitura in poliuretano espanso indeformabile in densità da 30 a 40 kg/m<sup>3</sup> e ovatta in poliestere. Base e fascia in laminato in vari colori. Resine e collanti utilizzati sono privi di sostanze ozonolesive, CFC e solventi clorurati. Tutti i materiali impiegati rispettano la normativa EU 91/156 per lo smaltimento dei rifiuti. Prodotto lavorato interamente a mano in Italia. Il pouf Tara è disponibile interamente rivestito in tessuto o con base in legno laminato.

E1 fir plywood frame featuring low formaldehyde emission. 30 to 40 kg/m<sup>3</sup> non-deformable polyurethane foam padding and polyester wadding. Laminated wood base (various colours available). The resins and adhesives we use are free of ozone-depleting substances, CFCs and chlorinated solvents. All the materials we use are in compliance with EU 91/156 regulations on waste disposal. Entirely handmade in Italy. The Tara pouf can be completely upholstered with fabric; alternatively it can feature a laminated wood base

Структура - многослойная фанера из ели разной толщины класса E1 с низкой эмиссией формальдегида. Внутреннее наполнение - недеформируемый пенополиуретан плотностью от 30 до 40 кг/м<sup>3</sup> и синтепон. Цоколь и центральная вставка - ламинат в различных цветах. Используемые типы смол и клеящих материалов не содержат озоноразрушающих веществ, хлорфторуглеродов и хлорсодержащих растворителей. Все материалы соответствуют требованиям EU 91/156 по утилизации отходов. Изделия ручной работы, полностью произведенные в Италии. Пуф Tara предлагается в двух вариантах: полностью в ткани или с ламинированным деревянным цоколем.

### Tara tex

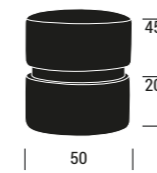

### Tara mix

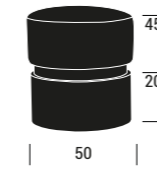

Rivestimento /  
Upholstery /  
Обивочная ткань  
①-Kauai Blush  
F1299/01



Anello in laminato 2008 vg SAT  
Laminate ring 2008 vg SAT  
Вставка: ламинат 2008 vg SAT



Rivestimento /  
Upholstery /  
Обивочная ткань  
①-Exotica Tropicale  
F1305/02 Citron



Anello in laminato 2000 vg SAT  
Laminate ring 2000 vg SAT  
Вставка: ламинат 2000 vg SAT



Rivestimento /  
Upholstery /  
Обивочная ткань  
①-Vegas Velvet Plain  
1403/67



Anello in laminato 2008 vg SAT  
Laminate ring 2008 vg SAT  
Вставка: ламинат 2008 vg SAT



Rivestimento /  
Upholstery /  
Обивочная ткань  
①-Vegas Velvet Plain  
1403/83



Anello in laminato 2008 vg SAT  
Laminate ring 2008 vg SAT  
Вставка: ламинат 2008 vg SAT

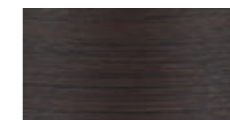

Base in laminato 4485 GHI  
Laminate base 4485 GHI  
Цоколь: ламинат 4485 GHI

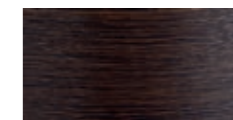

Base in laminato 4485 GHI  
Laminate base 4485 GHI  
Цоколь: ламинат 4485 GHI



Tavoli  
Tables  
СТОЛИКИ

173



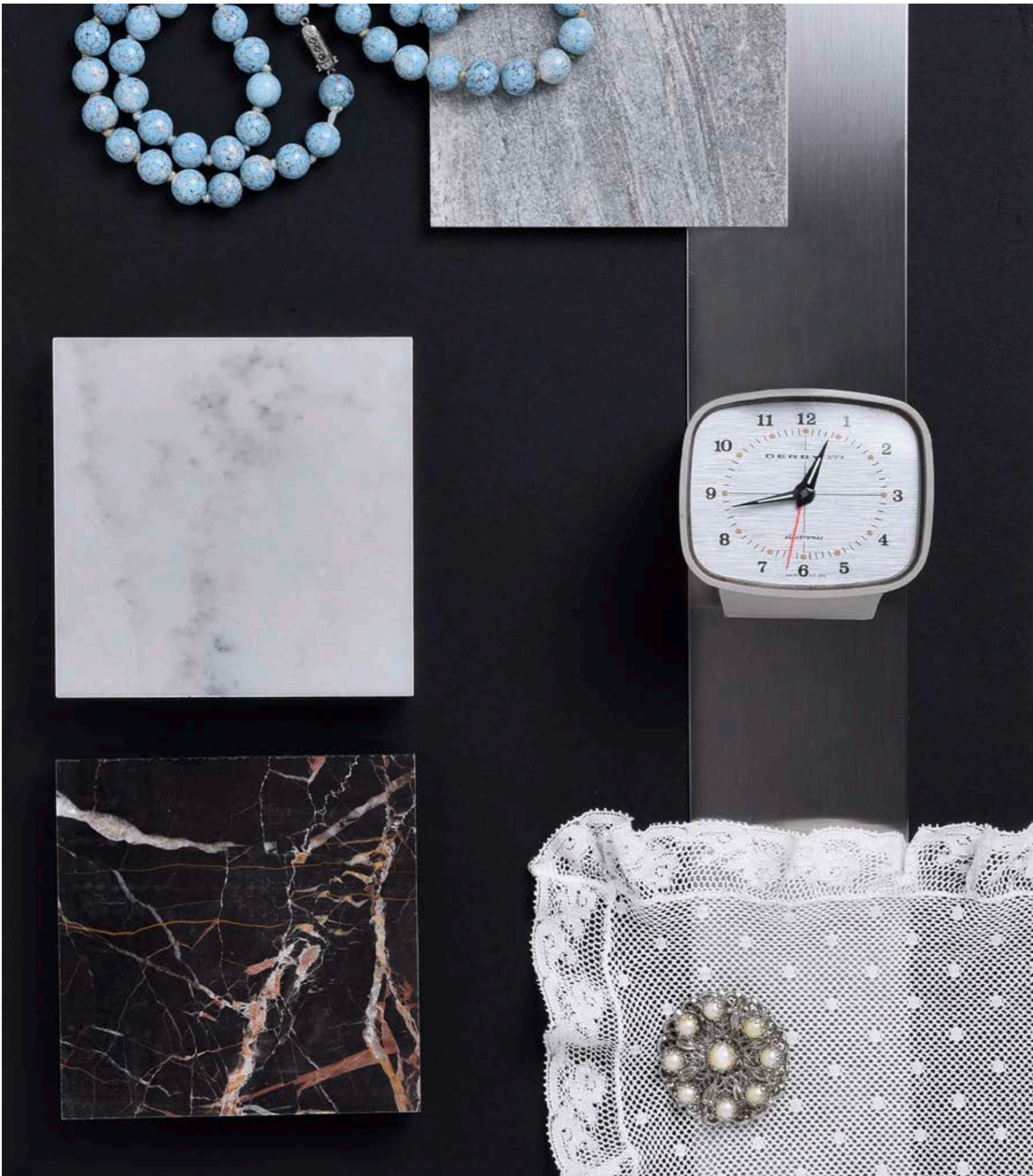

Forme morbide e giochi di ombre circolari per la collezione Febe, ispirata alla figura mitologica della omonima titanide, figlia di Urano e nonna di Artemide, tradizionalmente associata alla luna.

Soft shapes and circular shadows for the Febe series, which draws its inspiration from the homonymous titanide traditionally associated with the Moon, daughter of Uranus and grandmother of Artemis.

Мягкие формы и игра круглых теней характеризуют коллекцию Febe, посвященную одноименному мифологическому персонажу - титаниде, дочери Урана и бабушке Артемиды, которую традиционно связывают с луной.



# Febe





**Tavoli Tables Столики**  
Domingo—Luxury

**Febe**

TAVOLO TABLE СТОЛИК	POUF POUF ПУФ
<b>Sm D40xh57</b>	<b>D80xh24</b>
<b>Md D55xh40</b>	

### Finiture tavoli / Tables finishings / Отделки столиков



Palette strutture metallo e piani ceramica a pag. 202  
Page 202 metal frame palette and ceramic tops  
Палитра отделок металлических структур и керамических столешниц на стр. 202

# Febe

Struttura in metallo.

Finiture: versione ottone brunito verniciata a polveri, versioni ottone lucido e canna di fucile trattate con finitura galvanica e protezione trasparente. Piano in ceramica effetto marmo, spessore 0,6 cm ottenuto tramite cottura, spazzolatura e lucidatura meccanica. Superficie lucida, riflettente e antimacchia.

Metal frame.

Finishes: the burnished brass version features a powder-coated finish; the polished brass and gunmetal versions feature a galvanised finish with transparent protection. 0.6 cm-thick ceramic top with marble finish obtained by firing, brushing and mechanical polishing. Polished, reflective and stain-resistant surface.

Структура - металл.

Виды отделки: покраска в цвет полированной воронёной латуни; глянцевая латунь и canna di fucile (гальваника с прозрачным защитным покрытием). Столешница - керамика с эффектом мрамора, толщина 0,6 см, изготовлена посредством обжига, щеточной зачистки и механической полировки. Поверхность - глянцевая, отражающая и пятноустойчивая.

### Febe Sm tavolino



Finitura in canna di fucile lucido  
Polished gunmetal finishing  
Отделка: canna di fucile блестящая



Piano in ceramica effetto marmo Breccia  
Marble finish ceramic top Breccia  
Столешница: керамика с эффектом мрамора Breccia



Finitura in ottone lucido  
Polished brass finishing  
Отделка: глянцевая латунь



Piano in ceramica effetto marmo Onice Bamboo  
Marble finish ceramic top Onice Bamboo  
Столешница: керамика с эффектом мрамора Onice Bamboo



Finitura in ottone brunito satinato  
Satin burnished brass finishing  
Отделка: полированная воронёная латунь



Piano in ceramica effetto marmo Onice Bamboo  
Marble finish ceramic top Onice Bamboo  
Столешница: керамика с эффектом мрамора Onice Bamboo



Finitura in ottone brunito satinato  
Satin burnished brass finishing  
Отделка: полированная воронёная латунь

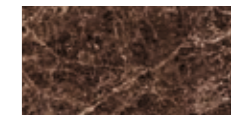

Piano in ceramica effetto marmo Emperador  
Marble finish ceramic top Emperador  
Столешница: керамика с эффектом мрамора Emperador

### Febe Md tavolino

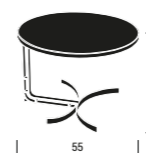

Finitura in canna di fucile lucido  
Polished gunmetal finishing  
Отделка: canna di fucile блестящая

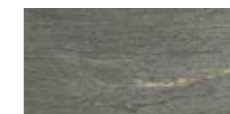

Piano in ceramica effetto marmo Majestic Marble 03  
Marble finish ceramic top Majestic Marble 03  
Столешница: керамика с эффектом мрамора Majestic Marble 03

### Febe pouf

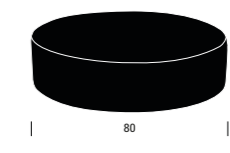

Rivestimento / Upholstery / Обивочная ткань  
①-8336/55



Rivestimento / Upholstery / Обивочная ткань  
①-Art.1469/60



Rivestimento / Upholstery / Обивочная ткань  
①-G075/234



Stilizzato, minimalista e impettito, il tavolo Ceo si ispira al titano portatore di intelligenza, il dio che incarna l'asse celeste attorno al quale ruota l'universo.

Stylised, minimalist and upright, the Ceo coffee table is inspired by the bearer of intelligence, the Titan God who embodies the celestial axis around which the heavens revolve.

Стилизованный, минималистский и горделиво смотрящийся столик Ceo напоминает нам о титане Кеосе, воплошающем разум и небесную ось, вокруг которой вращаются созвездия.



# Ceo



Tavoli Tables Столики  
Domingo—Luxury



Seo

TAVOLO TABLE СТОЛИК
<b>Sm D40xh63</b>
<b>Md D50xh43</b>
<b>Lg D60xh33</b>

### Finiture tavoli / Tables finishings / Отделки столиков



Palette strutture metallo e piani marmo a pag. 202  
Page 202 metal frame palette and marble tops  
Палитра отделок металлических структур и мраморных столешниц на стр. 202



# Ceo

Struttura in metallo.

Finiture: versione ottone brunito verniciata a polveri, versioni ottone lucido e canna di fucile trattate con finitura galvanica e protezione trasparente. Piano in marmo naturale protetto con antimacchia, spessore 2 cm.

Metal frame.

Finishes: the burnished brass version features a powder-coated finish; the polished brass and gunmetal versions feature a galvanised finish with transparent protection. Stain-resistant, 2 cm-thick natural marble top.

Структура - металл.

Виды отделки: покраска в цвет полированной воронёной латуни; глянцевая латунь и canna di fucile (гальваника с прозрачным защитным покрытием). Столешница из натурального мрамора с пятноустойчивым покрытием, толщина - 2 см.

### Ceo Sm



Finitura in ottone lucido  
Polished brass finishing  
Отделка: глянцевая латунь



Piano in marmo Moresco Imperiale  
Marble top Moresco Imperiale  
Столешница: мрамор Moresco Imperiale



Finitura in ottone brunito satinato  
Satin burnished brass finishing  
Отделка: полированная воронёная латунь



Piano in marmo Noir Saint Laurent  
Marble top Noir Saint Laurent  
Столешница: мрамор Noir Saint Laurent



Finitura in ottone brunito satinato  
Satin burnished brass finishing  
Отделка: полированная воронёная латунь



Piano in marmo Bianco Calacatta  
Marble top White Calacatta  
Столешница: мрамор Bianco Calacatta



Finitura in canna di fucile lucido  
Polished gunmetal finishing  
Отделка: canna di fucile глянцевая

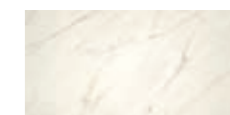

Piano in marmo Bianco Calacatta  
Marble top White Calacatta  
Столешница: мрамор Bianco Calacatta

### Ceo Md



Finitura in ottone brunito satinato  
Satin burnished brass finishing  
Структура: полированная воронёная латунь



Piano in marmo Noir Saint Laurent  
Marble top Noir Saint Laurent  
Столешница: мрамор Noir Saint Laurent

### Ceo Lg



Finitura in ottone brunito satinato  
Satin burnished brass finishing  
Структура: полированная воронёная латунь

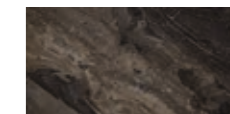

Piano in marmo Cappuccino  
Marble top Cappuccino  
Столешница: мрамор Cappuccino

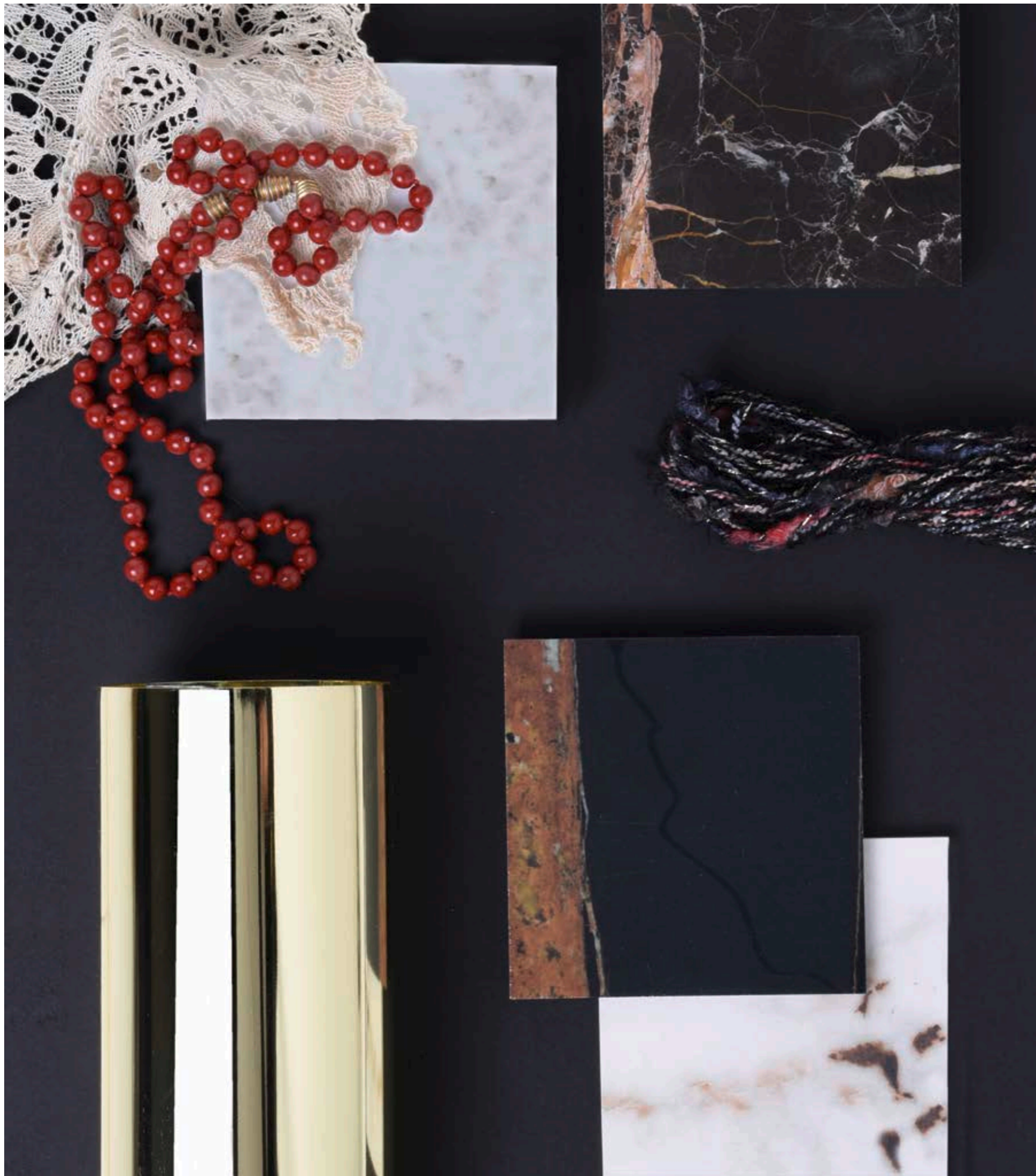

Cerchi concentrici che vivono a sé stanti o si incrociano e finiture che sfumano in colori indefiniti ispirati a Teti, la ninfa più belle delle Nereidi, dea dei mari e della metamorfosi.

Concentric circles that stand alone or overlap and finishes that fade into indefinite hues define Teti, the series that bears the name of the most beautiful nymph among the Nereids, goddess of waters and metamorphosis.

Концентрические круги, пересекающиеся или живущие сами по себе, и отделка, растворяющаяся в неопределенных тонах, навевают мысль о Teti, самой красивой нимфы из nereid, богиня морей и метаморфоза.



# Teti





**Tavoli Tables Столики**  
Domingo—Luxury

**Teti**

TAVOLO TABLE СТОЛИК
<b>Sm 42xh63</b>
<b>Md 52xh43</b>
<b>Lg 79.5xh32</b>

**Finiture tavoli / Tables finishings /  
Отделки столиков**



Palette strutture metallo e piani ceramica a pag. 202  
Page 202 metal frame palette and ceramic tops  
Палитра отделок металлических структур и керамических столешниц на стр. 202



# Teti

Struttura in metallo.  
Finiture: versione ottone brunito verniciata a polveri, versioni ottone lucido e canna di fucile trattate con finitura galvanica e protezione trasparente. Piano in ceramica effetto marmo, spessore 0,6 cm ottenuto tramite cottura, spazzolatura e lucidatura meccanica. Superficie lucida, riflettente e antimacchia.

Metal frame.  
Finishes: the burnished brass version features a powder-coated finish; the polished brass and gunmetal versions feature a galvanised finish with transparent protection. 0.6 cm-thick ceramic top with marble finish obtained by firing, brushing and mechanical polishing. Polished, reflective and stain-resistant surface.

Каркас - металл.  
Виды отделки: покраска в цвет полированной воронёной латуни; глянцевая латунь и canna di fucile (гальваника с прозрачным защитным покрытием). Столешница - керамика с эффектом мрамора, толщина 0,6 см, изготовлена посредством обжига, шеточной зачистки и механической полировки. Поверхность - глянцевая, отражающая и пятноустойчивая.

## Teti Sm

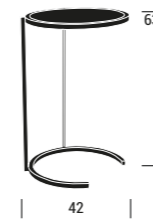

Finitura in ottone brunito satinato  
Satin burnished brass finishing  
Отделка: полированная воронёная латунь



Piano in ceramica effetto marmo Onice Bamboo  
Marble finish ceramic top Onice Bamboo  
Столешница: керамика с эффектом мрамора Onice Bamboo



Finitura in canna di fucile lucido  
Polished gunmetal finishing  
Отделка: canna di fucile глянцевая



Piano in ceramica effetto marmo Majestic Marble 03  
Marble finish ceramic top Majestic Marble 03  
Столешница: керамика с эффектом мрамора Majestic Marble 03



Finitura in ottone lucido  
Polished brass finishing  
Отделка: глянцевая латунь

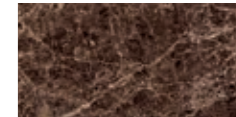

Piano in ceramica effetto marmo Emperador  
Marble finish ceramic top Emperador  
Столешница: керамика с эффектом мрамора Emperador

## Teti Md

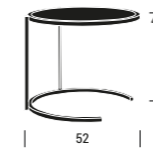

Finitura in ottone lucido  
Polished brass finishing  
Отделка: глянцевая латунь



Piano in ceramica effetto marmo Sahara Noir  
Marble finish ceramic top Sahara Noir  
Столешница: керамика с эффектом мрамора Sahara Noir

## Teti Lg



Finitura in ottone lucido  
Polished brass finishing  
Отделка: глянцевая латунь

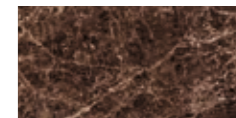

Piano in ceramica effetto marmo Emperador  
Marble finish ceramic top Emperador  
Столешница: керамика с эффектом мрамора Emperador



Geometrie scomposte creano interessanti effetti ottici che movimentano la regolarità delle forme squadrate di Rea, una collezione ispirata all'antica dea della terra, titanide e madre di Zeus.

Decomposed geometries create interesting optical effects that enliven the regularity of the square shapes of Rea, a series inspired by the ancient Titan goddess of the Earth, Zeus' mother.

Разнообразные геометрические мотивы создают интересный оптический эффект, который оживляет регулярность квадратных и прямоугольных форм коллекции Rea, посвященной древней богине земли, титаниде и матери Зевса.



# Rea



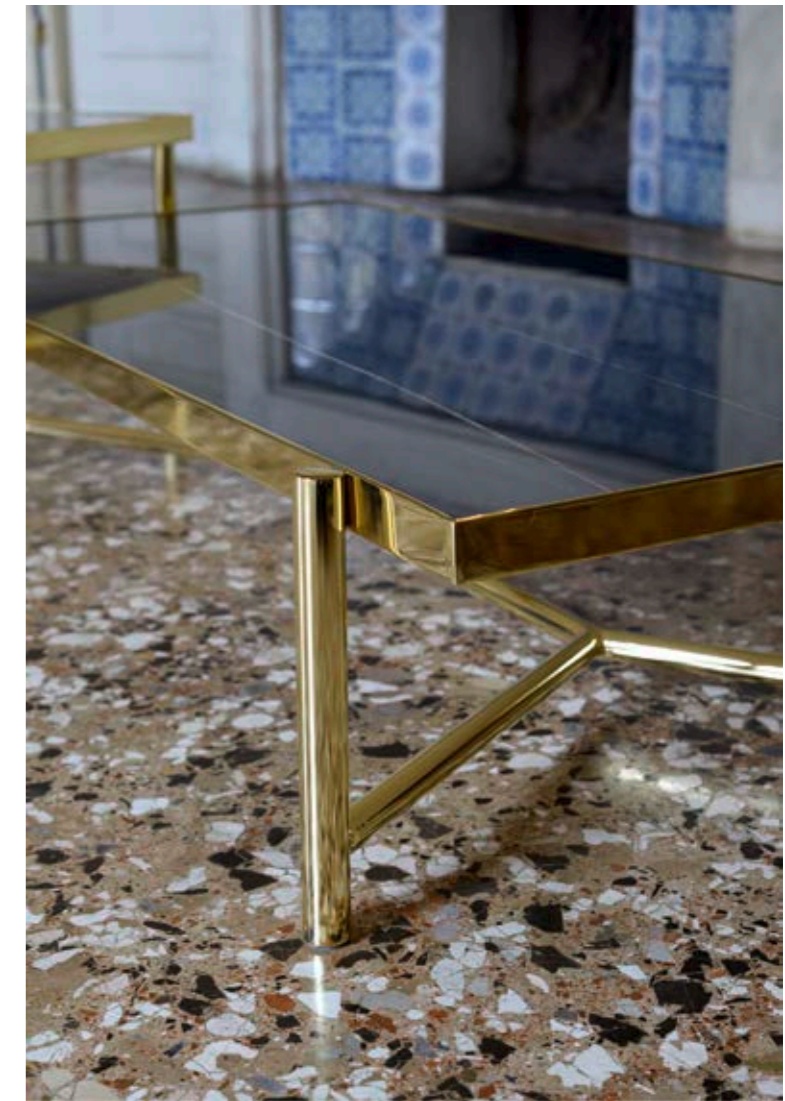

**Tavoli Tables Столики**  
Domingo—Luxury

Rea

TAVOLO  
TABLE  
СТОЛИК

**Sm 62.7x62.7xh35**

**Lg 122.7x62.7xh25**

### Finiture tavoli / Tables finishings / Отделки столиков



Palette strutture metallo  
e piani ceramica a pag. 202  
Page 202 metal frame  
palette and ceramic tops  
Палитра отделок  
металлических структур  
и керамических  
столешниц на стр. 202



# Rea

Struttura in metallo.

Finiture: versione ottone brunito verniciata a polveri, versioni ottone lucido e canna di fucile trattate con finitura galvanica e protezione trasparente. Piano in ceramica effetto marmo, spessore 0,6 cm ottenuto tramite cottura, spazzolatura e lucidatura meccanica. Superficie lucida, riflettente e antimacchia.

Metal frame.

Finishes: the burnished brass version features a powder-coated finish; the polished brass and gunmetal versions feature a galvanised finish with transparent protection. 0.6 cm-thick ceramic top with marble finish obtained by firing, brushing and mechanical polishing. Polished, reflective and stain-resistant surface.

Структура - металл.

Виды отделки: покраска в цвет полированной воронёной латуни; глянцевая латунь и саппа ді fucile (гальваника с прозрачным защитным покрытием). Столешница - керамика с эффектом мрамора, толщина 0,6 см, изготовлена посредством обжига, щеточной зачистки и механической полировки. Поверхность - глянцевая, отражающая и пятноустойчивая.

## Rea Sm



Finitura in ottone brunito satinato  
Satin burnished brass finishing  
Отделка: полированная воронёная латунь



Finitura in canna di fucile lucido  
Polished gunmetal finishing  
Отделка: canna di fucile глянцевая



Finitura in ottone lucido  
Polished brass finishing  
Отделка: глянцевая латунь



Piano in ceramica effetto marmo Breccia  
Marble finish ceramic top Breccia  
Столешница: керамика с эффектом мрамора Breccia



Piano in ceramica effetto marmo Onice Bamboo  
Marble finish ceramic top Onice Bamboo  
Столешница: керамика с эффектом мрамора Onice Bamboo

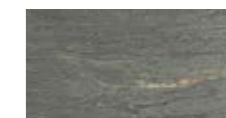

Piano in ceramica effetto marmo Majestic Marble 03  
Marble finish ceramic top Majestic Marble 03  
Столешница: керамика с эффектом мрамора Majestic Marble 03

## Rea Lg



Finitura in ottone brunito satinato  
Satin burnished brass finishing  
Отделка: полированная воронёная латунь

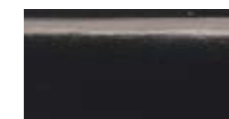

Finitura in canna di fucile lucido  
Polished gunmetal finishing  
Отделка: canna di fucile глянцевая



Finitura in ottone lucido  
Polished brass finishing  
Отделка: глянцевая латунь



Piano in ceramica effetto marmo Onice Bamboo  
Marble finish ceramic top Onice Bamboo  
Столешница: керамика с эффектом мрамора Onice Bamboo



Piano in ceramica effetto marmo Breccia  
Marble finish ceramic top Breccia  
Столешница: керамика с эффектом мрамора Breccia



Piano in ceramica Sahara Noir  
Marble finish ceramic top Sahara Noir  
Столешница: керамика с эффектом мрамора Sahara Noir

## Finiture parti metalliche / Metal parts finishings / Отделка металлических частей



Ottone brunito satinato  
Satin burnished brass  
Полированная воронёная латунь



Canna di fucile lucido  
Polished gunmetal  
Глянцевая сanna di fucile



Ottone lucido  
Polished brass  
Глянцевая латунь



Cromo satinato/lucido  
Polished/satin chrome  
Сатинировый/блестящий хром

## Finiture laminato / Laminate finishings / Отделка ламината



Ottone lucido  
Polished brass  
Глянцевая латунь  
2006 vg LUC

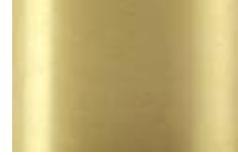

Ottone satinato  
Satin brass  
Латунь сатинированная  
2003 vg SAT



Cromo satinato  
Satin chrome  
Хром сатинированный  
2000 vg SAT



Canna di fucile lucido  
Polished gunmetal  
Глянцевая сanna di fucile  
2007 vg CT



Canna di fucile satinato  
Satin gunmetal  
Сатинированная сanna di fucile  
2012 vg SAT



Rame satinato  
Satin copper  
Медь сатинированная  
2008 vg SAT

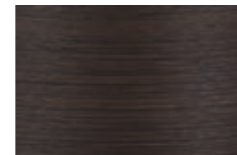

Wengé 4485 GHI  
Wengé 4485 GHI  
Венге 4485 GHI

## Finiture piani ceramica / Ceramic top finishings / Отделка керамических столешниц



Breccia



Majestic Marble 03



Onice Bamboo

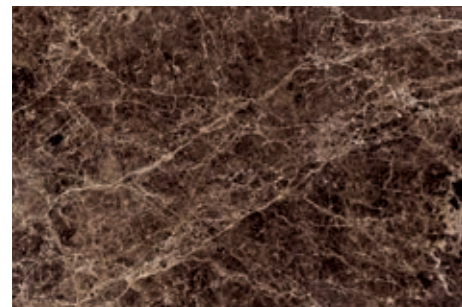

Emperador



Sahara Noir

## Finiture piani marmo / Marble top finishings / Мраморные столешницы



Bianco Carrara

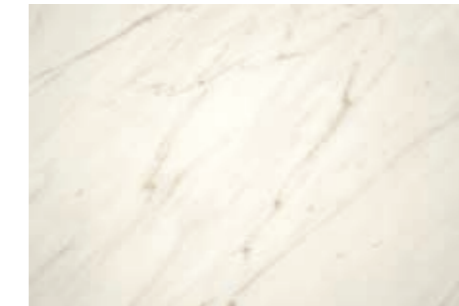

Bianco Calacatta

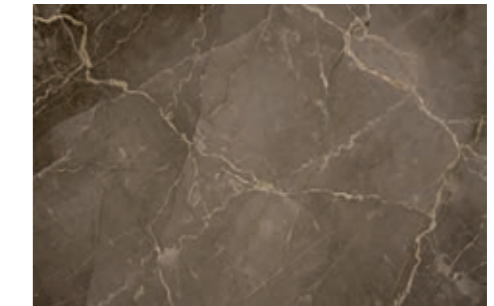

Moresco Imperiale



Cappuccino

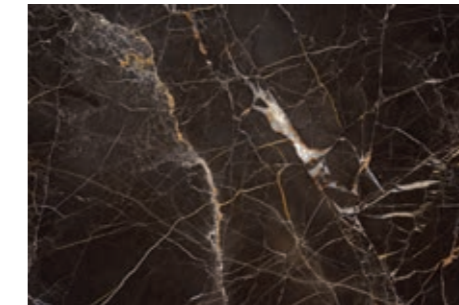

Noir Saint Laurent



Nero Marquina

## Chiodini metallici / Metal nails / Металлические заклепки



130-1/3 ø 13  
Bronzo sfumato  
Shaded bronze  
Полированная бронза



100-1/3 ø 10  
Cromo lucido  
Polished chrome  
Глянцевый хром



130-1/3 ø 13  
Oro invecchiato  
Aged golden  
Состарившееся золото



100-1/3 ø 10  
Oro lucido  
Polished gold  
Глянцевое золото



# Tessuti e pelli Fabrics and leathers Ткани и кожа

205



**Vimini / Guatavita**

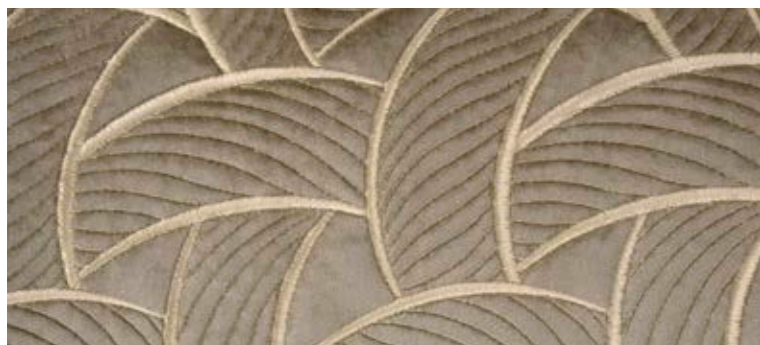

Vimini/44 plus



Guatavita/100 extra

G075/102 elegant

G075/416 elegant

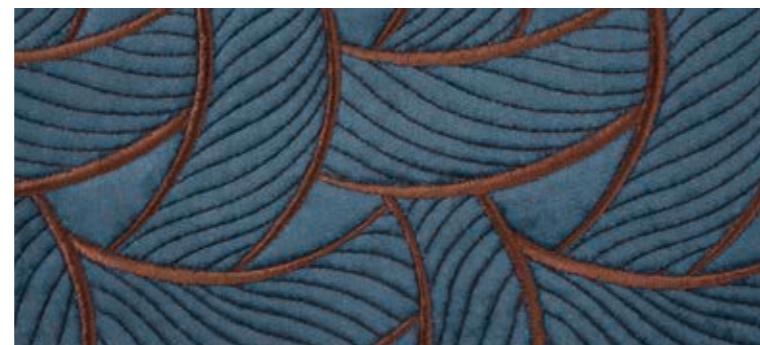

Vimini/10 plus

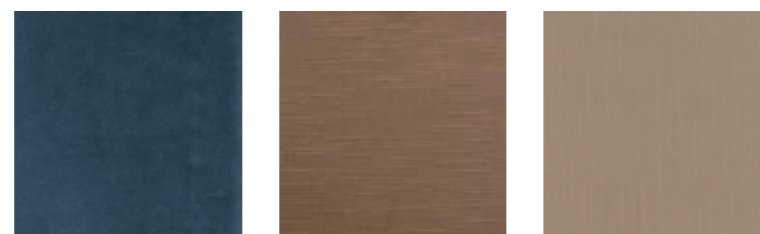

Guatavita/600 extra

Java Cocoa F0496/08 lusso

Java Sesame F0496/45 lusso

**Orfeo F7292 / Leonore F7291**



Orfeo F7292/01 Mint plus

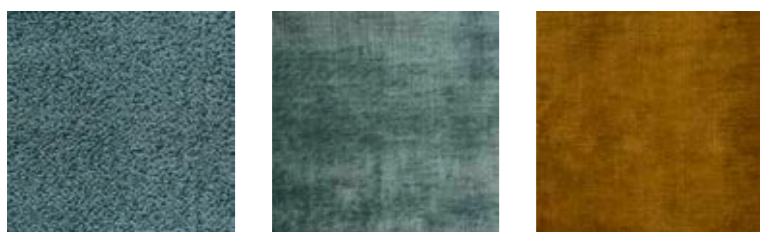

Leonore F7291/01 Ice extreme

Vegas Velvet Plain 1403/61 elegant

Vegas Velvet Plain 1403/02 elegant



Orfeo F7292/02 Silver plus



Leonore F7291/03 Silver extreme

Tivoli/29 extra

Tivoli/15 extra

**Maui / 1952 Dalia**



Maui Slate F1302/05 elegant



Brooklyn/07 extreme

Brooklyn/46 extreme



1952 Dalia/74 plus



Brooklyn/28 extreme

Brooklyn/15 extreme



Maui Natural F1302/04 elegant



Brooklyn/22 extreme

Brooklyn/02 extreme



1952 Dalia/90 plus



Brooklyn/19 extreme

Brooklyn/17 extreme

**Exotica Tropicale**



Exotica Tropicale Citron F1305/02 elegant



Exotica Tropicale Midnight F1305/04 elegant



8336/51 lusso



8336/3 lusso

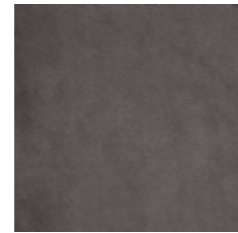

8336/5 lusso



8336/61 lusso

**Diamond Luxury / Mirage Luxury**

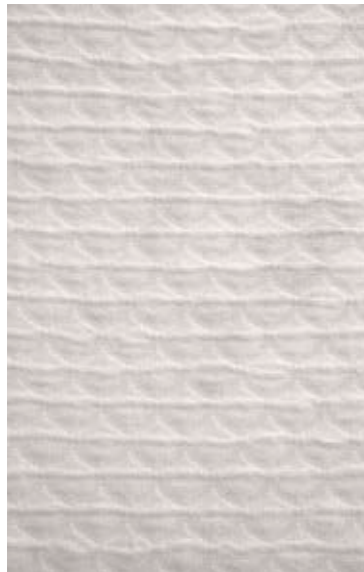

Diamond Luxury/01 extreme



Diamond Luxury/03 extreme



Diamond Luxury/04 extreme



Diamond Luxury/08 extreme

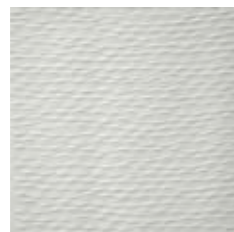

Mirage Luxury/01 extreme

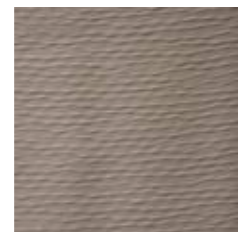

Mirage Luxury/03 extreme

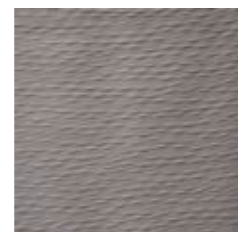

Mirage Luxury/04 extreme



Mirage Luxury/08 extreme

**19558 Renzo / Karma / 19554 Don Rodrigo / 80723 Crusca**



19558 Renzo/77 Porfido elegant

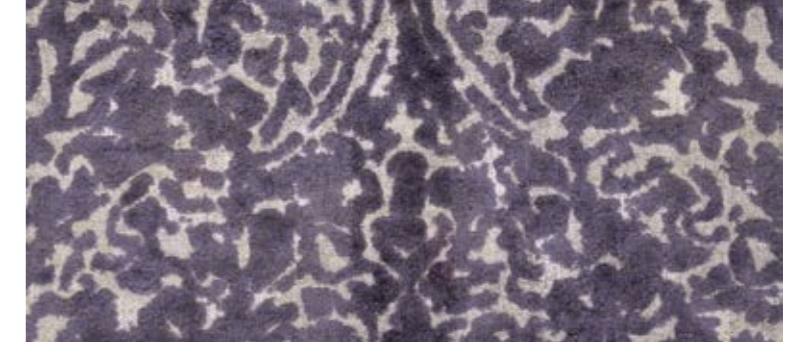

19554 Don Rodrigo/96 Prugna top



Karma/21 Tabacco elegant



Java Dusk F0496/12 lusso



Tivoli/11 extra

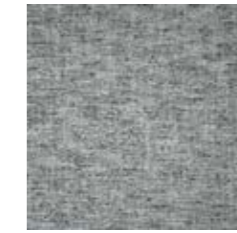

80723 Crusca/62 Grigio fumo extreme

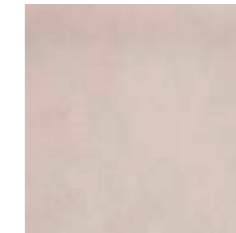

8336/51 lusso

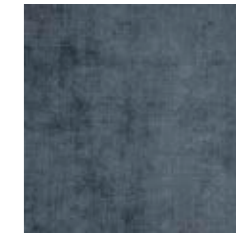

Vegas Velvet Plain 1403/84 elegant



19558 Renzo/50 Bronzo elegant



19554 Don Rodrigo/72 Opale top

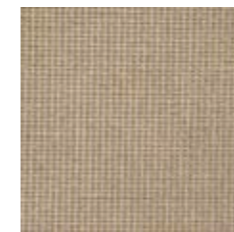

Karma/50 Platino elegant

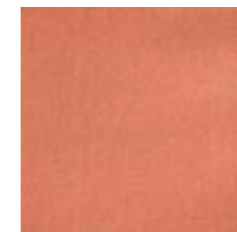

G075/456 elegant



Java Sesame F0496/45 lusso



80723 Crusca/46 Rame rosato extreme

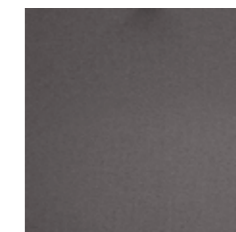

Tivoli/67 extra



8336/5 lusso

Bahamas / Small velvet / Kauai



Bahamas/4  
top



Small Velvet/45076  
top

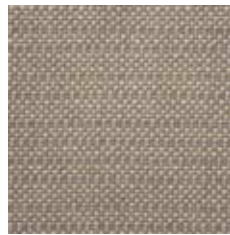

Kauai Mocha  
F1299/07  
extra



Bilbi/22  
extra



Bilbi/23  
extra



Kauai Kingfisher  
F1299/04  
extra



Tivoli/29  
extra



Tivoli/64  
extra



Bahamas/3  
top



Kauai Blush F1299/01  
extra

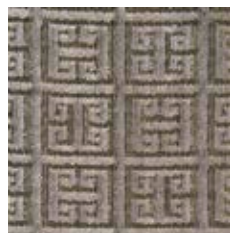

Small Velvet/45072  
top



Bilbi/11  
extra

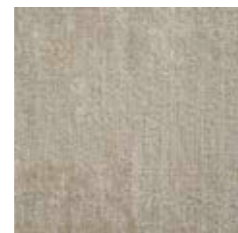

Bilbi/07  
extra

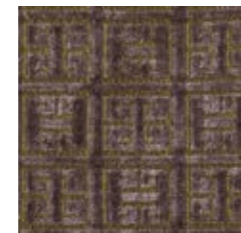

Small Velvet/45075  
top



Tivoli/04  
extra

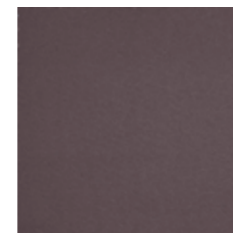

Tivoli/40  
extra

Struttura / Jungle velvet 1638 / Kauai

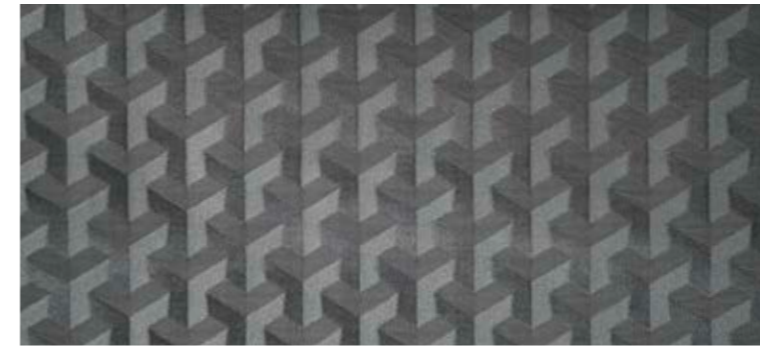

Struttura Pewter F1250/07  
extra



Jungle Velvet 1638/05  
elegant

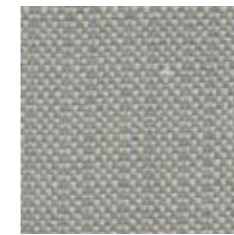

Kauai Mineral  
F1299/06  
extra



G075/414  
elegant



G075/312  
elegant

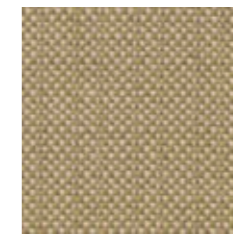

Kauai Citron F1299/03  
extra



Java Dove F0496/10  
lusso

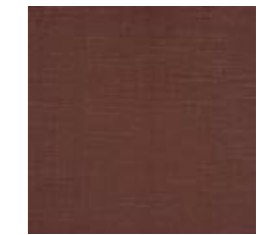

Java Mahogany  
F0496/27  
lusso



Struttura Champagne F1250/01  
extra



Jungle Velvet 1638/07  
elegant



Kauai Charcoal  
F1299/02  
extra



G075/208  
elegant

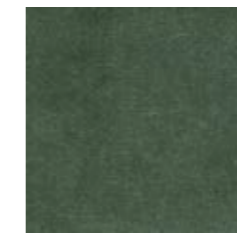

G075/234  
elegant



Kauai Mocha  
F1299/07  
extra



Java Putty F0496/41  
lusso



Java Spice F0496/48  
lusso

**La Moulade NCF4280**



La Moulade NCF4280/05 Blue/Linen top



Vegas Velvet Plain 1403/63 elegant



Vegas Velvet Plain 1403/61 elegant



Java Straw F0496/49 lusso



Java Sesame F0496/45 lusso



Vegas Velvet Plain 1403/78 elegant

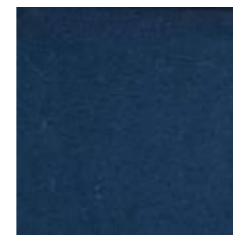

G075/416 elegant



Java Eau de nil F0496/14 lusso



Java Putty F0496/41 lusso

La Moulade NCF 4280/03 Beige/Teal/Chocolate top

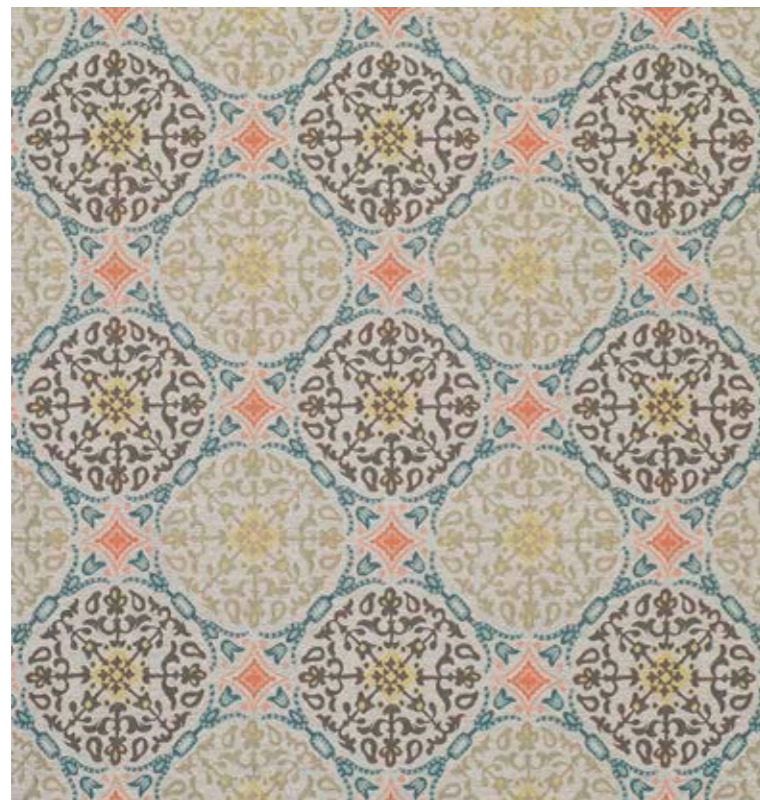

**Vegas Velvet Plain 1403**

elegant



38

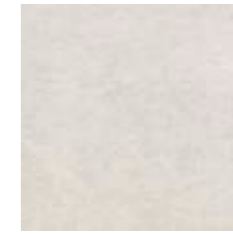

04



01

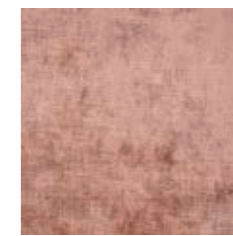

83

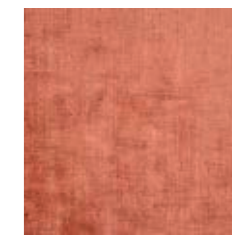

63

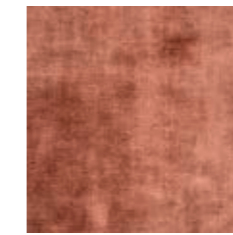

54

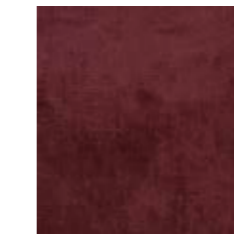

47



02



67

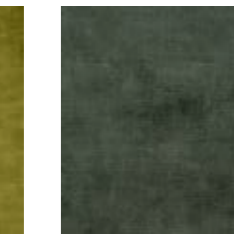

68

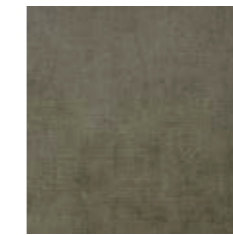

48



39

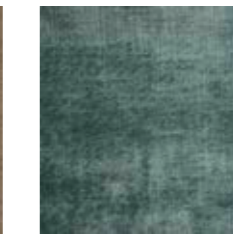

61

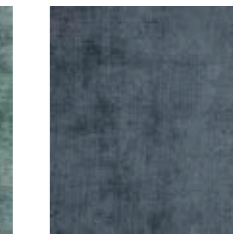

84

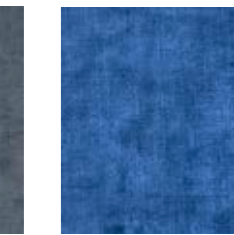

78



11



241

Brooklyn

extreme

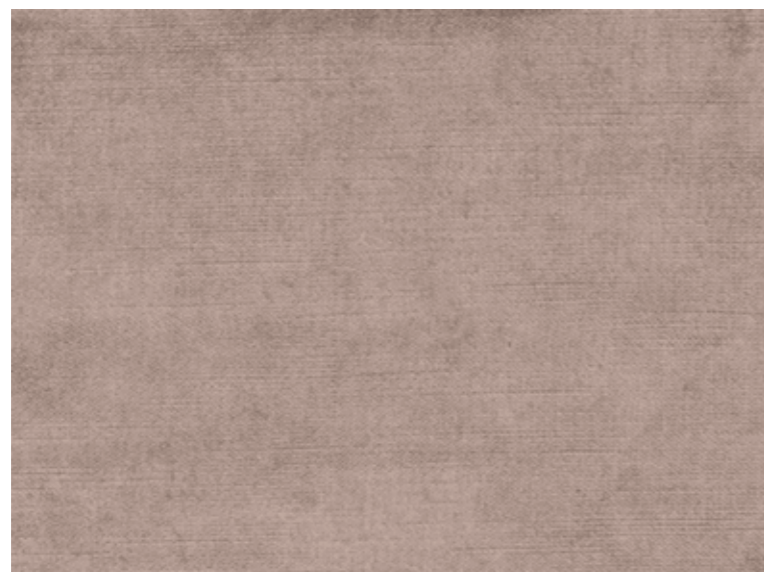

22



41

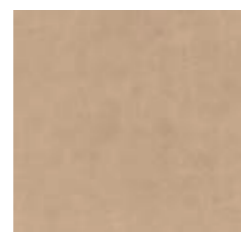

02

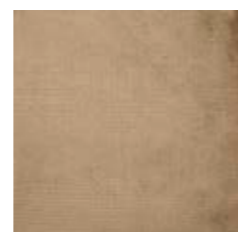

21

28



18

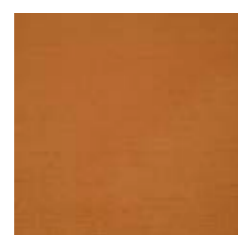

19



20

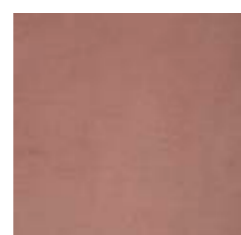

07



28

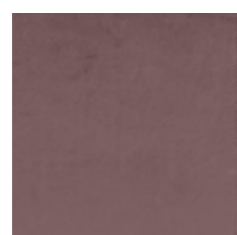

23

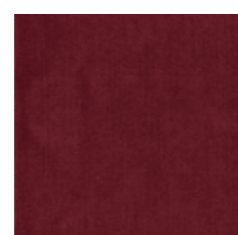

17



13

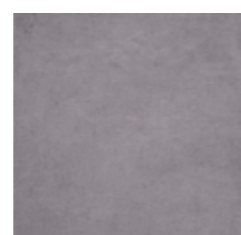

46

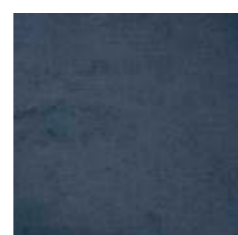

24



33

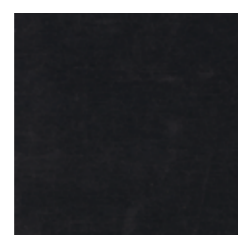

15

Tivoli

extra

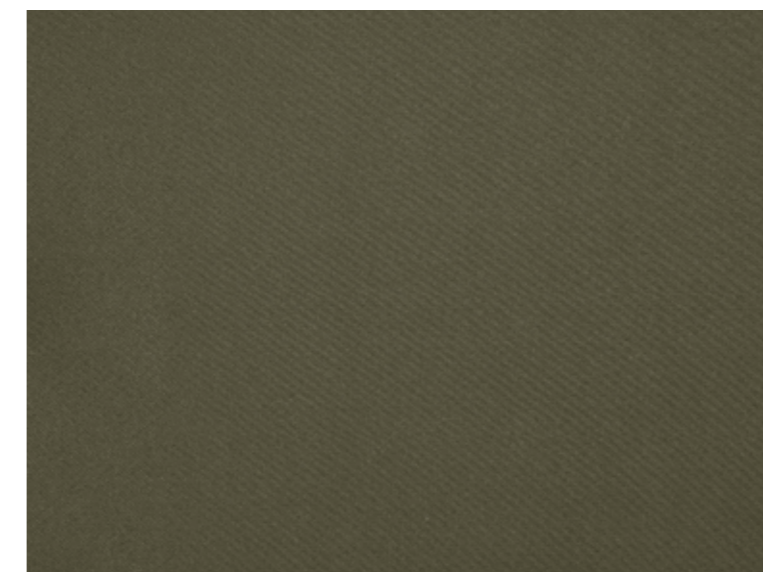

09



24



29

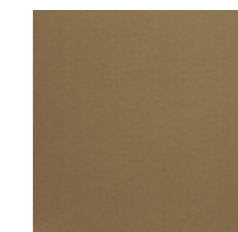

04

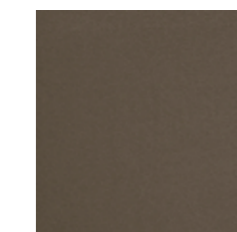

02

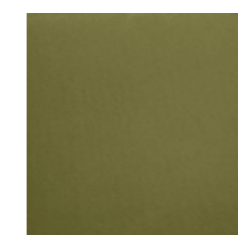

08

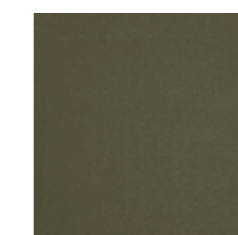

09



17



40



42

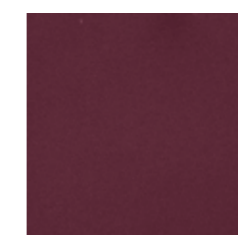

43

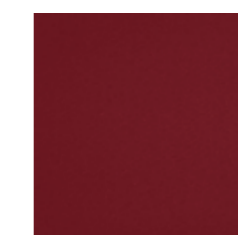

46

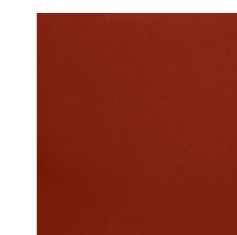

49



15



64



11

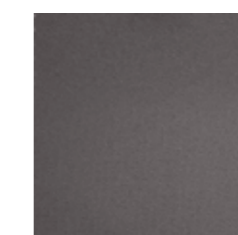

67

**Bilbi**

extra

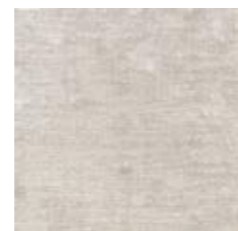

05

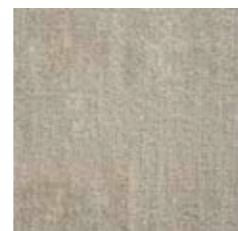

07

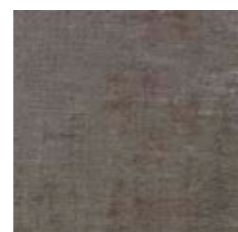

02

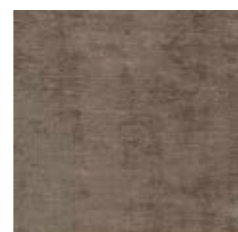

08

19

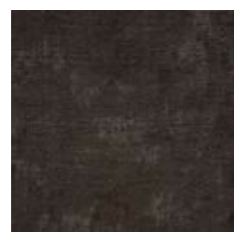

09

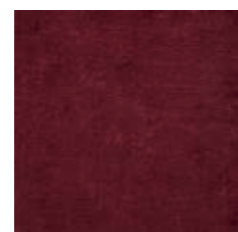

29



11

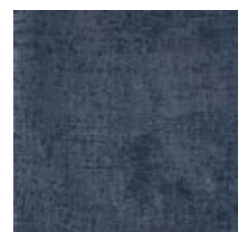

17



19



35



34

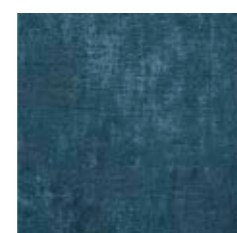

16



26

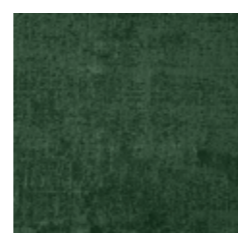

23



22

**G075**

elegant



208



003



102



230



857



312



338

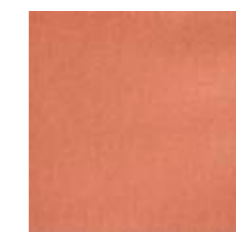

456



462



641



452



824

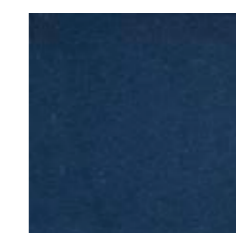

416

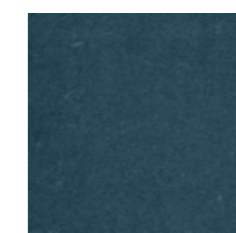

414



129

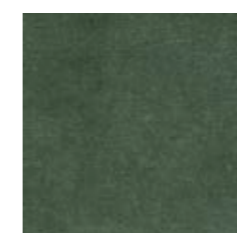

234

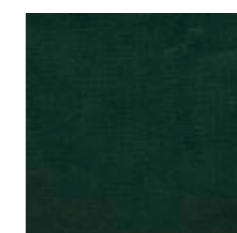

787

8336

lusso

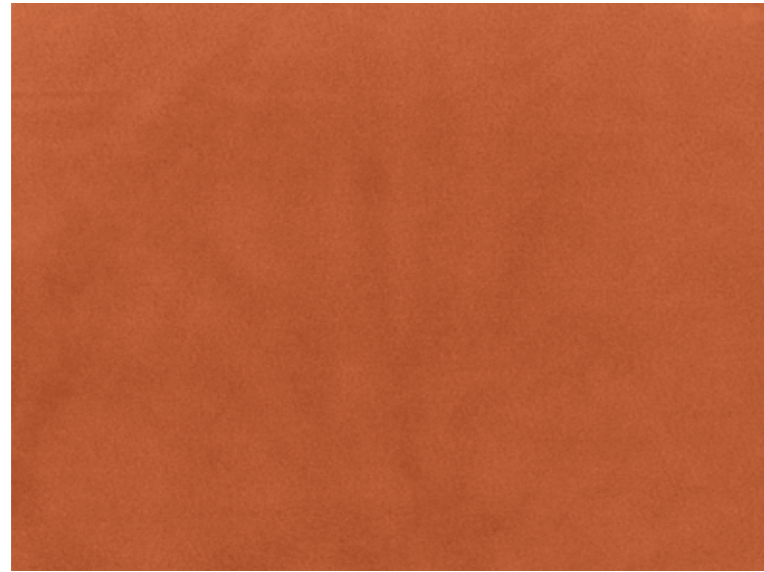

15



51



41



3



40



15



31



60



11



57

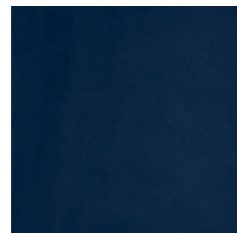

29



27



61

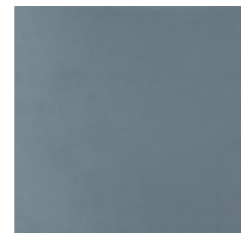

55



53



5



10

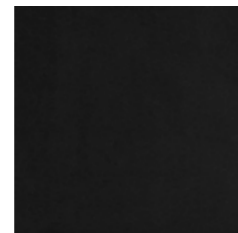

32

Trapuntature per art. 8336 / Upholstery stitching patterns for item 8336 / Прошивки для арт. 8336

super

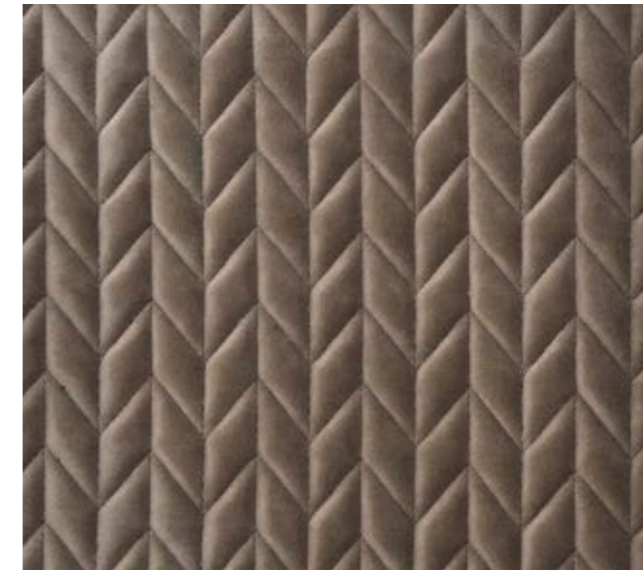

1456



1468



1469



1470

Al codice della trapuntatura scelta va associato il codice colore dell'art. 8336

Along with the quilting style chosen, please indicate the colour code of the fabric (art. 8336)

Код выбранного типа прошивки должен сочетаться с кодом цвета ткани арт.8336

**Java**

lusso



Pewter F0496/38



Buff F0496/03



Putty F0496/41



Sesame F0496/45

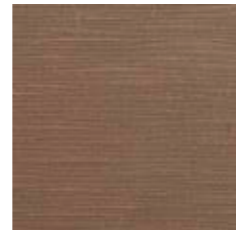

Cocoa F0496/08



Spice F0496/48

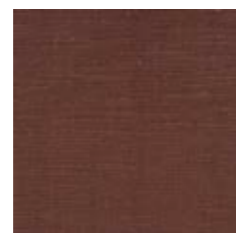

Mahogany F0496/27

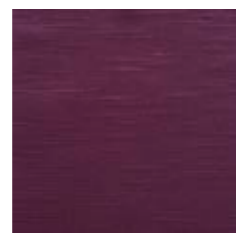

Grape F0496/19



Heather F0496/20



Eau De Nil F0496/14



Dusk F0496/12

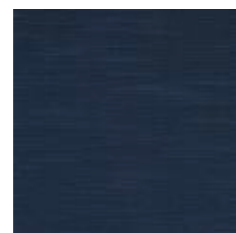

Midnight F0496/29

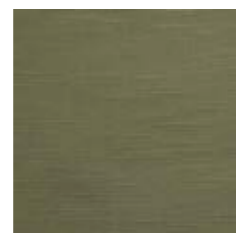

Moss F0496/33



Straw F0496/49



Dove F0496/10

**Basic**



443 Mauritius

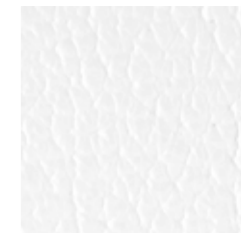

401 Bianco



417 Red

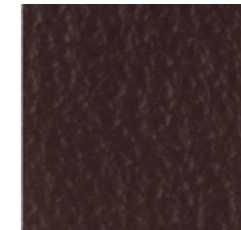

419 Burgundy

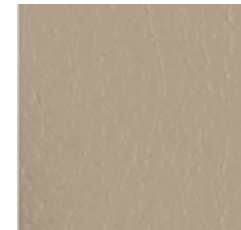

408 Fumo

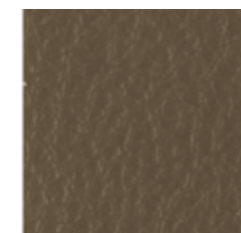

446 Military

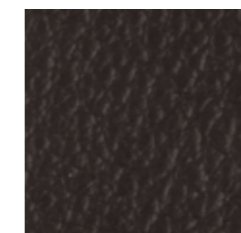

420 Testa di Moro

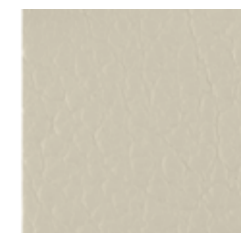

422 Acqua

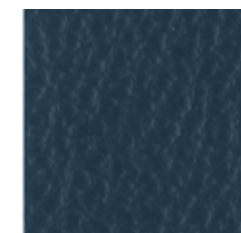

440 Denim



423 Nero

**Flower**

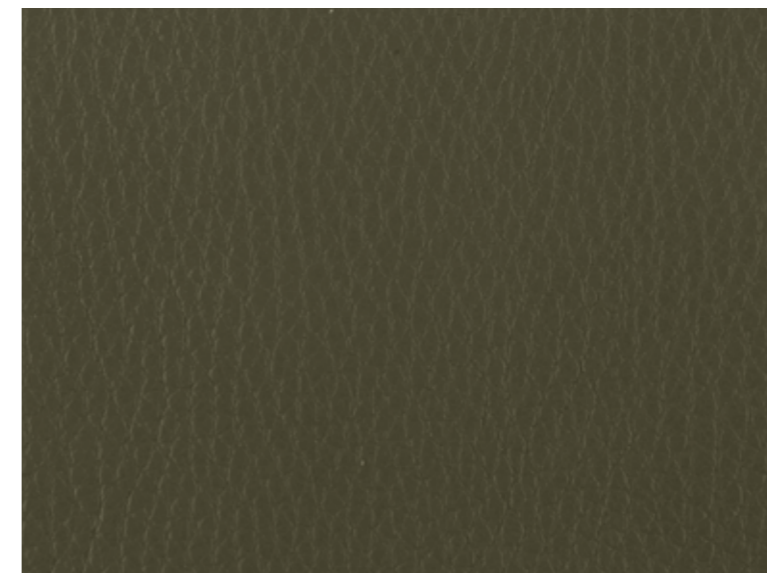

547 Musk



501 Bianco Ottico

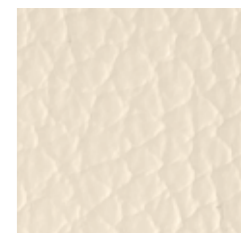

524 Magnolia

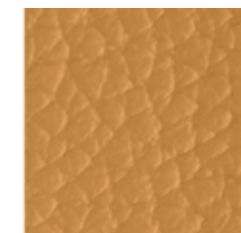

535 Cornflake



529 Fango

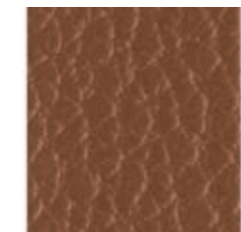

507 Terra

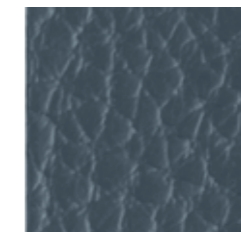

540 Slate Grey



532 Ecrú



519 Antracite

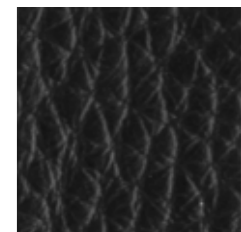

516 Nero





# Moon



692 Colvert

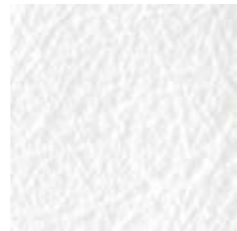

601 Bianco Ottico

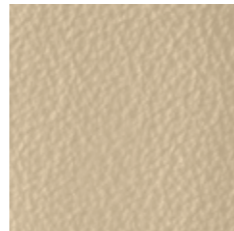

637 Caffelatte



619 Giallino



613 Mattone

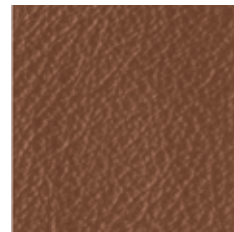

662 Fondotinta

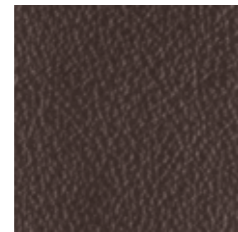

610 Mogano



660 Asfalto



651 Rosa Antico

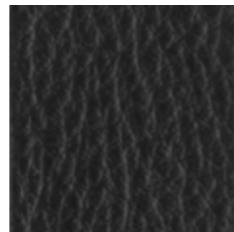

622 Nero

# Old

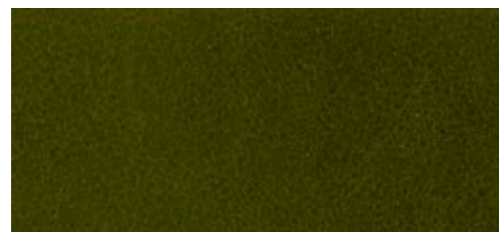

1

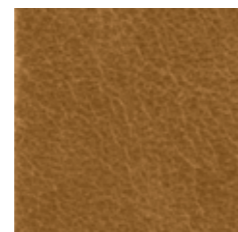

3

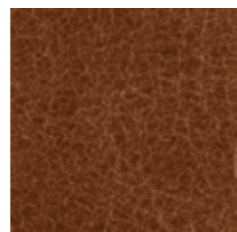

6

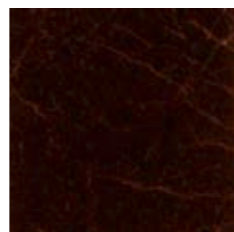

5

# Lux

top



2434



2408

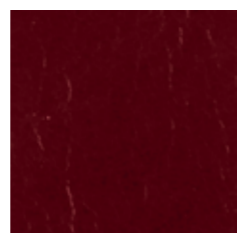

2407

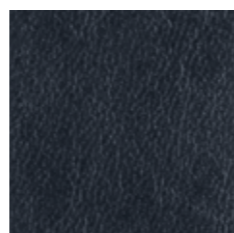

2438

222

Pelli Leathers Кожа Domingo—Luxury

# Rétro

extreme



4025

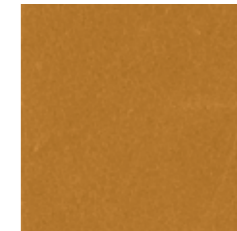

4022



4019

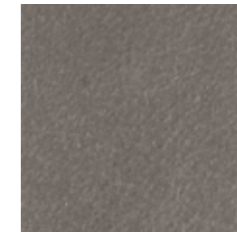

4007



4018

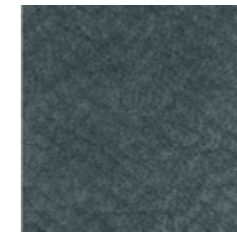

4020

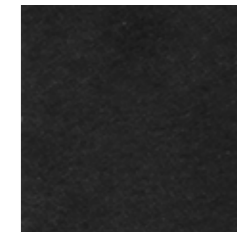

4027

# Nabuk

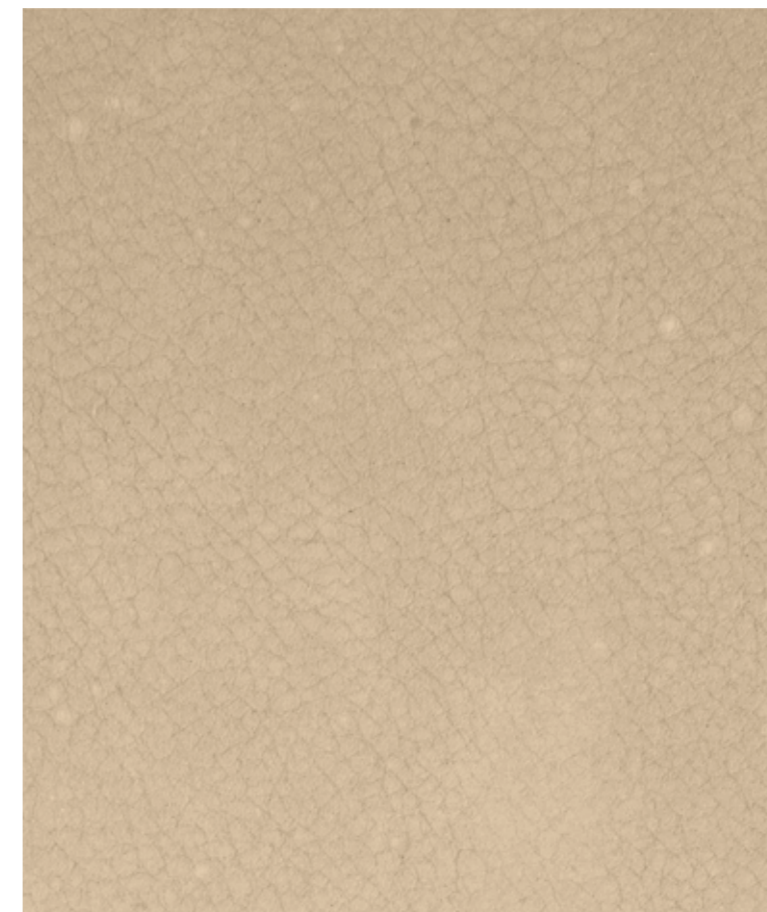

3



15

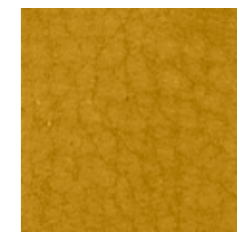

22



8

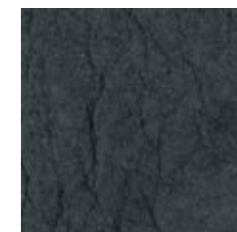

12

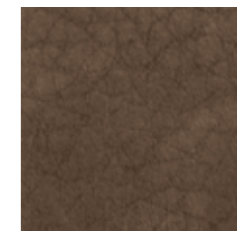

16



27  
223

## Informazioni tecniche tessuti / Technical data on fabrics / Технические характеристики тканей

### 19552 Dalia

83% VI - 13% SE - 4% PA
371gr/m²
↑63 cm ↔68.5 cm
H 137 cm

### 19554 Don Rodrigo

57% VI - 28% LI - 15% PL
327 gr/m²
↑36 cm ↔35 cm
H 138 cm

### 19558 Renzo

55% VI - 45% PL
264 gr/m²
↑2.3 cm ↔2.2 cm
H 140 cm

### 80723 Crusca

41% VI - 25% CO - 16% LI - 14% PL - 4% PA
550 gr/m²
H 140 cm

### 8336

100% PL
460 gr/m²± 5%
H ≥140 cm

### Bahamas

55% CO - 45% VI
614 gr/m²
↑62 cm ↔66 cm
H 140 cm

### Bilbi

65% PC - 35% PL
557 gr/m²±5%
H 140 cm ±2%

### Brooklyn

19% CO - 65% VI - 16%PL -
Pile 100% VI
486 gr/m²
H 140 cm

### Diamond Luxury

70% PL FR - 30% PL
230 gr/m²
↑2.5 cm ↔2.5 cm
H 305/310 cm

### Exotica Tropicale

63% PL - 21% VI - 16% CO
571 gr/m²
↑40 cm ↔34.5 cm
H 138 cm

### G075

100% CO
580 gr/m²± 2%
H 140 cm ± 2%

### Guatavita

100% PL
350 gr/m²
H 140 cm

### Java

62% CO - 38% PL
235 gr/m²
H 148 cm

### Jungle Velvet 1638

85% PL - 15% VI
571 gr/m²
↑60.5 cm ↔70 cm
H 140 cm ± 2%

### Karma

54% PL - 22% CO - 13% VI - 9% PC - 2% ME
443 gr/m²
H 140 cm

### Kauai

46% CO - 42% PL - 12% VI

560 gr/m²

H 134 cm

### La Moulade NCF4280

79% VI - 21% PL
622 gr/m²
↑33 cm ↔33 cm
H 134 cm

### Leonore F7291

50% VI - 28% CO - 22% PL
651 gr/m²
H 140 cm

### Maui

48% PL - 30% VI - 22% CO
558 gr/m²
↑3.7 cm ↔3.4 cm
H 137 cm

### Mirage Luxury

50% PL FR - 50% PL
270 gr/m²
H 300/305 cm

### Orfeo F7292

60% VI - 35% CO - 5% PL
490 gr/m²
H 141 cm

### Small Velvet

Pile 100% VI
Warp 100% PL
207 gr/m²
↑3 cm ↔3 cm
H 142 cm

### Struttura

35% VI - 33% PL - 32% CO

310 gr/m²

↑2.9 cm ↔4.7 cm

H 139 cm

### Tivoli

60% CO - 40% PL
218 gr/m²
H 137 cm

### Vegas Velvet Plain 1403

55% VI - 45% CO
780 gr/m²±4%
H 140 cm

### Vimini

100% PL
350 gr/m²
↑16.5 cm ↔16 cm
H 140 cm

## Informazioni tecniche pelli / Technical data on leather / Технические характеристики кожи

### Basic

pelle bovina mezzo fiore stampata
spessore: 0.8-1.0 mm
superficie media: 4.8-5.0 m²

corrected and embossed

cowhide for enhanced grain consistency

thickness: 0.8-1.0 mm
average size of each hide is around 4.8-5.0 m²

тисненая полулицевая кожа

крупного рогатого скота

толщина: 0,8-1,0 мм

средняя площадь: 4,8-5,0 м²

### Flower

pelle bovina mezzo fiore stampata
spessore: 0.8-1.0 mm
superficie media: 4.8-5.0 m²

corrected and embossed

cowhide for enhanced grain consistency

thickness: 0.8-1.0 mm
average size of each hide is around 4.8-5.0 m²

тисненая полулицевая кожа

крупного рогатого скота

толщина: 0,8-1,0 мм

средняя площадь: 4,8-5,0 м²

тисненая полулицевая кожа

крупного рогатого скота

толщина: 0,8-1,0 мм

средняя площадь: 4,8-5,0 м²

### Old

pelle bovina a grana fine
spessore: 1.2 mm
superficie media: 6.0 m²

Fine-grained cowhide for

enhanced grain consistency

thickness: 1.2 mm

average size of each hide is around 6.0 m²

мелкозернистая кожа

крупного рогатого скота

толщина: 1,2 мм

средняя площадь: 6,0 м²

натурально-зернистая

полулицевая

кожа крупного рогатого скота

толщина: 0,9-1,1 мм

средняя площадь: 4,8-5,0 м²

натурально-зернистая

полулицевая

кожа крупного рогатого скота

толщина: 0,9-1,1 мм

средняя площадь: <5,0 м²

натурально-зернистая

полулицевая

кожа крупного рогатого скота

толщина: 0,9-1,1 мм

средняя площадь: <5,0 м²

### Moon

pelle bovina mezzo fiore a grana naturale
spessore: 0.9-1.1 mm
superficie media: 4.8-5.0 m²

lightly buffed natural

grain cowhide

thickness: 0.9-1.1 mm

average size of each hide is around 4.8-5.0 m²

натурально-зернистая

полулицевая

кожа крупного рогатого скота

толщина: 0,9-1,1 мм

средняя площадь: 4,8-5,0 м²

натурально-зернистая

полулицевая

кожа крупного рогатого скота

толщина: 0,9-1,1 мм

средняя площадь: 4,8-5,0 м²

натурально-зернистая

полулицевая

кожа крупного рогатого скота

толщина: 0,9-1,1 мм

средняя площадь: 4,8-5,0 м²

натурально-зернистая

полулицевая

кожа крупного рогатого скота

толщина: 0,9-1,1 мм

средняя площадь: 4,8-5,0 м²

### Rétro

pelle bovina
spessore: 0.9-1.1 mm
superficie media: 4.8-5.0 m²

cowhide with a distressed

vintage effect

thickness: 0.9-1.1 mm

average size of each hide is around 4.8-5.0 m²

кожа крупного

рогатого скота

толщина: 0,9-1,1 мм

средняя площадь: 4,8-5,0 м²

## Palazzo Milzetti Faenza

Museo Nazionale dell'età neoclassica in Romagna



"Dai diamanti non nasce niente, dal letame nascono i fiori". Questo deve aver pensato e sperato il conte Nicola Milzetti quando, nel 1792, affidò all'architetto Giuseppe Pistocchi l'incarico di costruire il proprio palazzo partendo dalle diroccate case di famiglia danneggiate dal sisma nel 1781. I lavori si protrassero fino al 1808 quando la famiglia Milzetti lo vendette, dopo aver speso gli ultimi 20 anni ad impreziosirlo e adornarlo di pitture e stucchi di grottesche e trompe l'oeil che nulla hanno da invidiare ai più bei palazzi romani o di altre capitali europee. Raffinato ed elegante, mai con eccesso o arroganza, Palazzo Milzetti rimane uno degli edifici più interessanti e al tempo stesso sconosciuti dell'intera Romagna. Dal 2001 sede del Museo dell'età neoclassica in Romagna, ci dona un pretesto per farsi visitare e ammirare.

"Nothing grows out of diamonds, but flowers spring up from manure": this must have been the thought and the hope that in 1792 pushed

Earl Nicola Milzetti to commission architect Giuseppe Pistocchi the construction of his Palace after the 1781 earthquake had greatly damaged his family's home. The building process lasted until 1808, when the Milzetti family sold the palace after having spent twenty years embellishing and decorating it with frescoes, Grottesque stuccoes and trompe l'oeil that are no less gorgeous than what you find in noble palaces in Rome or in other European capitals. Sophisticated and elegant without excess nor arrogance, Palazzo Milzetti remains one of the most interesting, although little known, buildings in the Romagna region. Since 2001, it has hosted the Museum of the Neoclassic Period in Romagna, which should be a reason in itself to plan a visit.

"Ничего не родят алмазы, а цветы из грязи рождаются". Так, полагается, думал и желал граф Никола Мильцетти, когда в 1792 году поручил архитектору Джузеппе Пистокки построить для себя дворец

из руин, которые оставались на месте домов, принадлежавших его семейству и разрушенных землетрясением в 1781 году. Работы велись до 1808 года, когда семейство Мильцетти решило продать дворец, после того, как на протяжении последних 20 лет украшало его росписями, лепниной, изображающей гротескные фигуры, и тромплями, которые своей красотой не уступают убранству самых красивых дворцов Рима или других европейских столиц. Роскошный и элегантный, и при этом лишенный надменности и излишеств, Палаццо Мильцетти остается одним из самых прекрасных и в то же время мало известных зданий в Романье. С 2001 года в стенах дворца располагается музей неоклассического искусства Романьи, предоставляя нам тем самым повод посетить его, чтобы восхититься его красотой.

## Palazzo Rasponi delle Teste Ravenna



Quasi tre secoli di attenta e ricercata costruzione, ci hanno restituito uno dei palazzi più belli dell'intera Ravenna. Dietro una severa e classicista facciata di quasi 70 metri, si cela un cuore morbido di barocco e rococò, quasi a testimoniare l'incessante scorrere di tre lunghi secoli, in cui la famiglia Rasponi attraversò altalenanti periodi di grandezza e importanza. Doppi volumi si intersecano con decorazioni sinuose ed inusuali e la rigida simmetria esterna dialoga felicemente con la morbidezza degli ambienti interni. Dopo un attento restauro, ad oggi, i suoi sontuosi spazi, di proprietà del Comune di Ravenna, sono dedicati a mostre, concerti ed eventi culturali.

It took almost three centuries to build this Palace, recently restored to the grandeur that makes it one of the most striking buildings in Ravenna. A 70-metre wide classically rigorous façade hides a soft rococo and baroque heart, revealing the time span over which the Rasponi family saw to the completion

of their family residence despite periods of decreasing financial and social influence. Double volumes intersect with sinuous and unusual decorations while the rigid external symmetry happily interacts with the softness of the interiors. Today, its sumptuous spaces, owned by the Municipality of Ravenna, are dedicated to exhibitions, concerts and cultural events.

Почти три века ушло на усердное и тщательное строительство, в результате которого мы получили один из самых красивых дворцов Равенны. Строгий фасад, выполненный в стиле классицизма и простирающийся на 70 метров, скрывает нежное сердце барокко и рококо, свидетельствующих о непрерывном течение трех веков, за которые семейство Распони познало чередующиеся периоды величия и падения. Двойные объемы пересекаются с извилистым и необычным декором, а жесткая внешняя

симметрия гармонично переключается с мягкостью интерьеров. После тщательной реставрации в роскошных интерьерах дворца, который на сегодняшний день принадлежит мэрии Равенны, проходят выставки, концерты и культурные мероприятия.

# DOMINGO®

Strada della Romagna, 285  
61121 PESARO (ITALY)  
T +39 0721 208080  
info@domingo.it  
www.domingo.it

Direzione artistica Art direction	<b>Valentina Bigiarini &amp; Francesca Grassi</b>
Product design	<b>Arch. Mattia Santucci Rimini</b>
Grafica Graphic design	<b>ma:design Pesaro</b>
Foto Photo	<b>Mauro Foli Cervia</b>
Stampa Print	<b>Grapho 5 Fano</b>
	 <b>Palazzo Rasponi delle Teste Ravenna Palazzo Milzetti Faenza - Museo Nazionale dell'età neoclassica in Romagna</b> Su concessione del Ministero per i beni e le attività culturali e per il turismo - Polo Museale dell'Emilia-Romagna
Ringraziamento speciale a special thanks to	
Cartoline Postcards pag.8-50-76-120-130-142-162	<b>Deirdre Dyson Exclusive Carpets and Rugs</b> <b>www.deirdredyson.com</b>
Edizione 1 Issue 1	<b>Novembre 2020</b> <b>November 2020</b>

Luxury living

**ROOM**  
*Luxembourg*

ROOM Luxembourg S.à r.l.  
11, Um Lënsterbiërg  
L-6125 Junglinster

+352 288 00 11  
[www.room-luxembourg.lu](http://www.room-luxembourg.lu)  
[info@room-luxembourg.lu](mailto:info@room-luxembourg.lu)

domingo.it